



AFBAT®

CATALOGUE GÉNÉRAL



Fabricant
Français

TOUT POUR VOTRE HABITAT !

GRILLES DE DÉFENSE DESIGN P.243



SOLANO

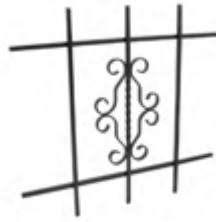

MARINE



LIBECCIO



VENDÉE



BORA



ASTRALE

GRILLES DE DÉFENSE TÉLESCOPIQUES P.240



1 BARREAU



2 BARREaux

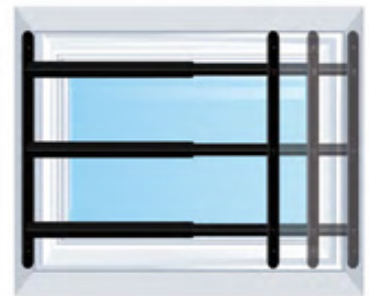

3 BARREaux

NOUVELLE GAMME D'ACCESSOIRES POUR VOLET ALUMINIUM P.180



UN SAVOIR-FAIRE FRANÇAIS

AFBAT DÉTIENT UNE FORTE EXPÉRIENCE DANS LA FABRICATION DE SES PIÈCES DE QUINCAILLERIE. DEPUIS SON INTÉGRATION DANS LE GROUPE TORBEL, AFBAT BÉNÉFICIE DE TOUT SON SAVOIR-FAIRE DE FABRICANT FRANÇAIS.

1

UN BUREAU D'ÉTUDE INNOVANT

La création de nos pièces commence par une idée.

De cette idée découle une réflexion sur sa conception, son design et son ergonomie pour ensuite élaborer les étapes de fabrication.

Avant de lancer notre produit sur le marché, un prototype du produit est conçu dans le but de tester sa résistance, sa qualité et sa durée de vie. Une fois ces étapes validées, la production en grande série débute en supervisant continuellement le respect de la qualité du produit.

Un produit n'est jamais fini, et AFBAT® prône l'amélioration continue.



2

12 USINES DE FABRICATION

AFBAT s'appuie sur 12 usines de fabrication, spécialisées par secteur d'activité.

Une production qualitative alliant la haute technologie et le travail de forge artisanal avec la fabrication de grilles de défense, de ferrures de volet, de paumelles, de poignées de porte et de charnières.

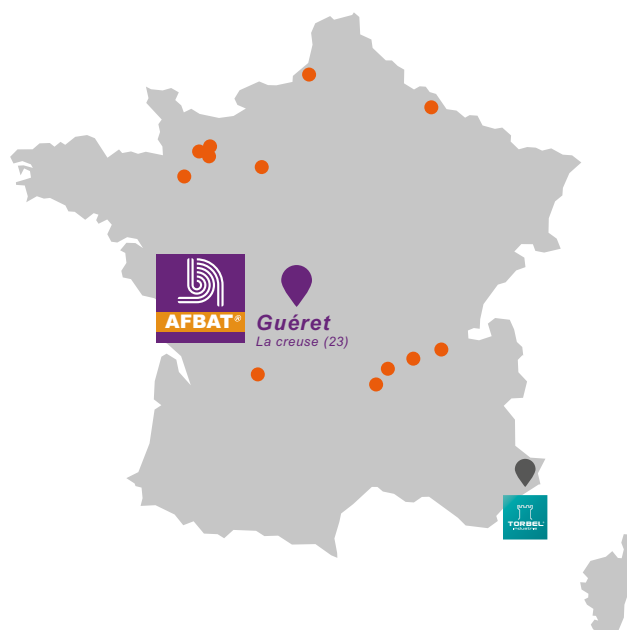

3

DES USINES DE TRAITEMENT DE SURFACE



Le laquage

Peinture réalisée par poudrage électrostatique, puis cuite au four.



La cataphorèse

Dépôt de peinture par électrophorèse.

4

UNE PLATEFORME LOGISTIQUE QUI STOCKE PLUS DE 4000 RÉFÉRENCES.



Notre plateforme logistique : Préparation de 32 000 palettes par an

L'INTÉRIEUR DE L'HABITAT



La porte



La fenêtre



Les moustiquaires



L'aménagement intérieur



La quincaillerie d'ameublement



Le rangement

L'EXTÉRIEUR DE L'HABITAT



La clôture



La porte de garage



Le portail

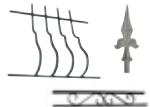

Les grilles de défense



Les connecteurs



Le volet



La quincaillerie de bâtiment



La ferronnerie



LA PORTE INTÉRIEURE

15 - 64

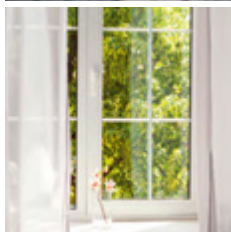

LA FENÊTRE

65 - 70

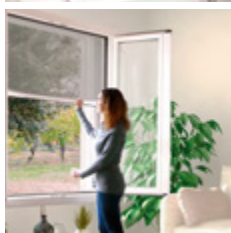

LES MOUSTIQUAIRES COSI

71 - 84

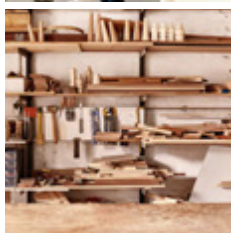

LE RANGEMENT

85 - 86

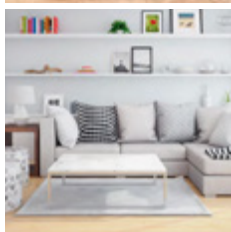

L'AMÉNAGEMENT INTÉRIEUR

87 - 96

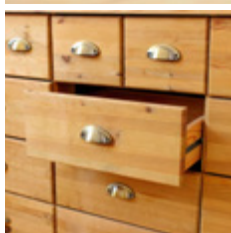

LA QUINCAILLERIE

97 - 108

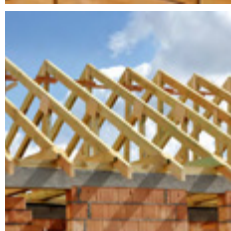

LES CONNECTEURS

109 - 132

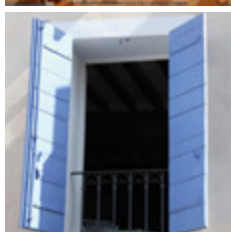

LE VOLET

133 - 208



L'INOX

209 - 216



LA PORTE EXTÉRIEURE

217 - 224



LA SÉCURITÉ

225 - 238



LA GRILLE DE DÉFENSE

239 - 264

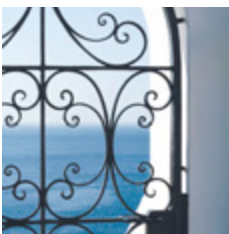

LA FERRONNERIE

265 - 288



LE PORTAIL

289 - 312



L'AMÉNAGEMENT EXTÉRIEUR

313 - 318



GAMME HYSOS

319 - 324

NOTRE CONCEPT MERCHANDISING

1 DES PRODUITS PACKAGÉS COMPLETS

Une ILV entièrement fournie.

OBJECTIF : Améliorer le repérage et renforcer la segmentation.



• Des frontons :



• Des kakémonos :

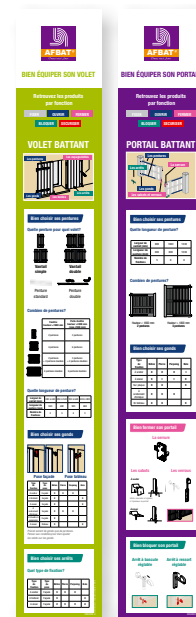

• Des étiquettes de balisage :



2 DES UNIVERS AVEC LEURS PROPRES CODES COULEURS

OBJECTIF : Mieux identifier les gammes.

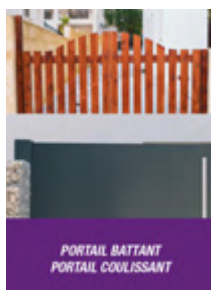

3

DES PRODUITS PACKAGÉS COMPLETS

OBJECTIF : Moins de plastique

Moins de plastique

AFBAT a engagé une démarche d'amélioration de ses packagings produits en réduisant sa consommation de plastique dans ses emballages. Les cartonnettes avec lien nylon seront privilégiées dans nos futurs développements et renouvellements de stock. Aucun changement de dimension de nos packs ne sera fait pour ne pas perturber les plans merchandising en cours.



- Des produits plus visibles et mis en situation.

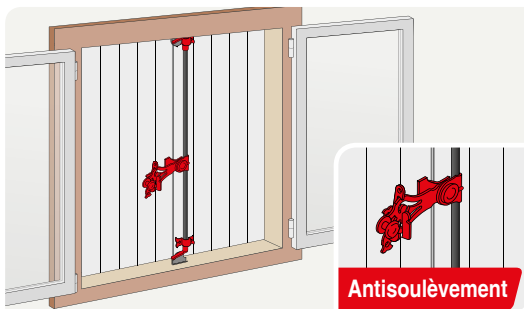

- Des notices de pose

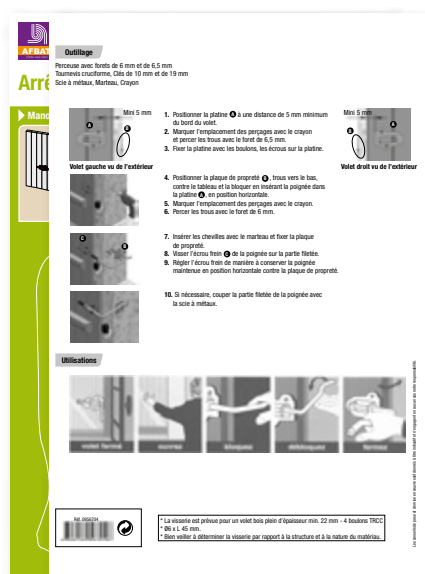

NOTRE CONCEPT MERCHANDISING

4

UN MATÉRIEL D'AGENCEMENT OPTIMISÉ

Pour les produits brochés : des broches spécifiques pour pentures, pentures anglaises, crochets et verrous baïonnettes ont été développées.

OBJECTIF : Améliorer la présentation des produits en rayon.



*Nos broches répondent aux exigences de sécurité de la norme NF E25.080.
Il appartient à chaque magasin de respecter les consignes de montage notées sur chaque broche.*

5

LA QBOX : LE CONCEPT EXCLUSIF AFBAT

Une innovation qui s'adapte aux différentes configurations des magasins.

Le système de réhausse offre une meilleure visibilité des produits et un autofacing.



REPÈRES CATALOGUE

Les pictogrammes

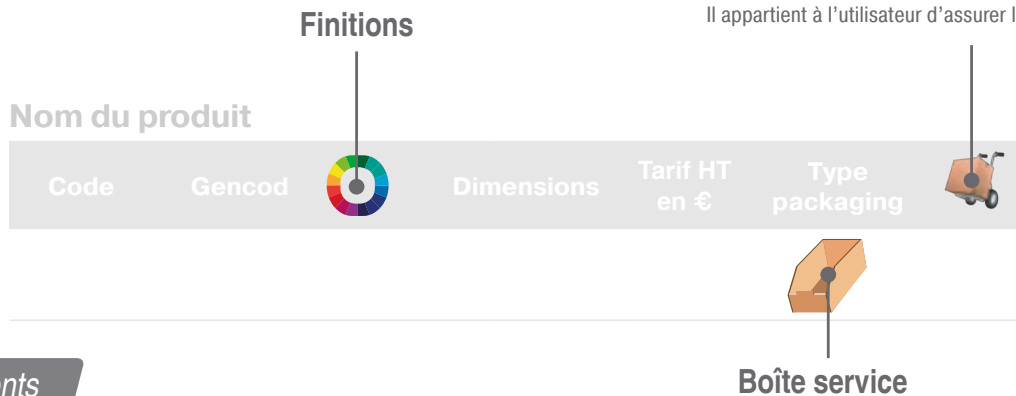

Les percements

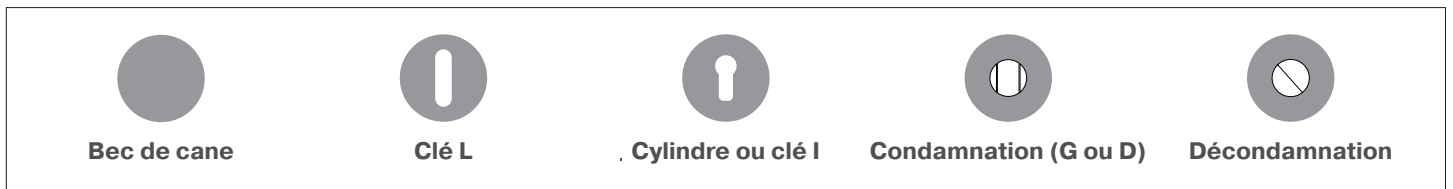

Les finitions



Acier brut

BRUT

Acier chromé brillant

CHROME BRILLANT

Acier patiné verni

ACIER PATINÉ CLAIR VERNI

Acier vieux bronze

ACIER VIEUX BRONZE

Apprêt

APPRET

Argent

ARGENT

Argent cimenté

ARGENT CÉMENTÉ

Beige

BEIGE

Blanc

BLANC

Blanc laqué

LAQUÉ

Blanchie

BLANCHI

Bronzé

BRONZÉ

Brut

BRUT

Canon de fusil brillant

CANON DE FUSIL BR.

Champagne

CHAMPAGNE

Chevron noir

CHEVRON

Chrome

CHROME

Chromé

CHROME

Chrome brillant

CHROME BRILLANT

Chrome satiné

CHROME SATINÉ

Découpé noir

DÉC. NOIR

Double protection

DP

Epoxy blanc

EPOXY

Epoxy noir

EPOXY

Fer brut

FER BRUT

Fer patiné

FER PATINÉ

Fer rouillé

FER ROUILLÉ

Fonte

FONTE

Galvanisé

GALVA.

Granite

GRANITE

Gris

GRIS

Gris patiné

GRIS PATINÉ

Inox

INOX

Inox 316 L

INOX 316 L

Inox brillant

INOX BR.

Inox brossé

INOX BROSSÉ

Inox brossé / blanc laqué

INOX BROSSÉ BLANC LAQ.

Inox poli

INOX POLI

Inox poli / blanc laqué

INOX POLI BLANC LAQ.

Laiton

LAITON

Laiton brillant

LAITON BR.

Laitonné

LAITONNÉ

Laitonné poli

LAITONNÉ POLI

Laitonné vieilli

LAITONNÉ VIEILLI

Marron

MARRON

Naturel poncé

NATUREL

Nickelé

NICKELÉ

Nickelé brillant

NICKELÉ BR.

Nickelé satiné

NICKELÉ S.

Nickelé satiné / chrome

NICKELÉ S. CH

Noir

NOIR

Noir mat

NOIR MAT

Orange Laiton

ORANGE

Patiné cimenté

C.PATINÉ

RAL 3004

3004

RAL 5003

5003

RAL 5012

5012

RAL 6021

6021

RAL 9005

9005

RAL 9016

9016

Rouge

ROUGE

Sable gris

SABLE

Sable noir

SABLE

Vert

VERT

Zingué blanc

Z.BLANC

FINITIONS

Acier

Définition :

L'acier est un alliage métallique constitué principalement de fer et de carbone, dans des proportions comprises entre 0,02 % et 2 % en masse.

Cet alliage a une bonne résistance mécanique.

Il peut recevoir une finition peinture.



Sur quel support ?	BOIS
Avantage	Bonne résistance mécanique
Utilisation	Intérieur / Extérieur
Traitement	Cataphorèse / Zingage / Galvanisation
Couleur	Epoxy selon RAL

Aluminium

Définition :

L'aluminium est un élément chimique : métal, malléable à souhait, de couleur argentée, qui est remarquable pour sa résistance à l'oxydation et sa faible densité.

Il peut recevoir une couche de peinture.



Sur quel support ?	ALU / PVC / BOIS
Avantage	Très bonne résistance à la corrosion
Utilisation	Intérieur / Extérieur
Traitement	-
Couleur	Epoxy selon RAL

Composite

Définition :

Terme général utilisé pour les matières plastiques telles que les polyamides (chargés ou non en fibre de verre), les polypropylènes ou ABS.



Sur quel support ?	ALU / PVC / BOIS
Avantage	Excellente résistance à la corrosion
Utilisation	Intérieur / Extérieur
Traitement	-
Couleur	Epoxy selon RAL

Cupro

Définition :

Alliage de cuivre et d'aluminium. Les Cupro-aluminiums contiennent, selon les nuances, des additions de nickel, de fer ou de manganèse améliorant ainsi leurs propriétés.

Ces alliages ont une excellente résistance à la corrosion, aux chocs, aux vibrations, à l'usure et au matage.



Sur quel support ?	ACIER / ALU / PVC
Avantage	Excellente résistance mécanique
Utilisation	Intérieur / Extérieur
Traitement	-
Couleur	Epoxy selon RAL

Fonte

Définition :

Alliage de fer et de carbone contenant plus de 1,8% de carbone.

Peut-être laqué.



Sur quel support ?	BOIS
Avantage	Bonne résistance mécanique
Utilisation	Intérieur / Extérieur
Traitement	-
Couleur	Epoxy selon RAL

Inox

Définition :

Acier inoxydable. Les éléments d'alliage accroissent la stabilité de la couche passive des inox dans un environnement déterminé et permettent à certaines nuances d'inox de résister à la corrosion dans des milieux qui peuvent être particulièrement agressifs. Il existe une multitude de nuances d'inox, différenciés par les éléments d'alliages introduits lors de l'élaboration afin d'augmenter la stabilité de la couche passive. Il existe par exemple les inox 304, 304L, 316L.

Il convient donc de sélectionner la nuance la mieux appropriée.



Sur quel support ?	ALU / PVC / BOIS
Avantage	Excellente résistance mécanique
Utilisation	Intérieur / Extérieur
Traitement	-
Couleur	Epoxy selon RAL

Laiton

Définition :

Alliage de cuivre et de zinc (5 à 42 %).



Sur quel support ?	ALU / PVC / BOIS
Avantage	-
Utilisation	Intérieur / Extérieur
Traitement	-
Couleur	Epoxy selon RAL

Zamak

Définition :

Alliage de zinc, aluminium, magnésium, et cuivre (Kupfer).

Le zamak peut être laqué à condition d'opérer un dégazage.



Sur quel support ?	ALU / PVC / BOIS
Avantage	Très bonne résistance à la corrosion
Utilisation	Intérieur / Extérieur
Traitement	-
Couleur	Epoxy selon RAL

TRAITEMENTS

Anodisation

Définition :

Traitement de surface de type conversion qui permet de protéger ou de décorer une pièce en Aluminium, par oxydation anodique (couche électriquement isolante de 5 à 50 micromètres). Elle octroie aux matériaux une meilleure résistance à l'usure, à la corrosion et à la chaleur. L'épaisseur est en fonction de la destination du produit final.



Entretien	Un nettoyage régulier des surfaces est recommandé avec un détergent à pH doux (compris entre 5 et 8).
IMPORTANT	Par temps très froid, ne posez pas une main humide sur une surface anodisée : le phénomène de gel est accéléré et vous resteriez très solidement collé.

Apprêt

Définition :

Peinture Hydrodiluable (peinture à l'eau) séchée à l'air chaud qui confère au produit une bonne résistance à la corrosion pendant le stockage et aux intempéries. Utilisé comme sous-couche sur pièce en fonte BRUT, le traitement ne nécessite pas de décapage avant la couche de peinture définitive. Les produits traités à l'APPRÊT permettent un stockage avant peinture plus long évitant les phénomènes de rouille.



Entretien	-
IMPORTANT	Un produit brut doit être peint pour éviter toute oxydation. Pour les pièces grasses, un dégraissage est nécessaire avant peinture.

Blanchi

Définition :

Poudre talc déposée sur le produit BRUT afin de limiter et retarder les effets indésirables de l'humidité. Le blanchissement ne constitue pas un traitement contre la corrosion.

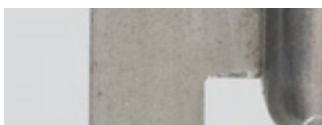

Entretien	-
IMPORTANT	Un produit blanchi doit être traité pour le protéger de la corrosion.

Brut

Définition :

Etat naturel du métal. Absence de traitement de surface, peut présenter des traces d'oxydation ou des traces d'huile.



Entretien	-
IMPORTANT	Un produit brut doit être peint pour éviter toute oxydation. Pour les pièces grasses, un dégraissage est nécessaire avant peinture.

Cataphorèse

Définition :

Technique de dépôt par électrophorèse de peinture pour un dépôt uniforme sur toute la surface de la pièce.

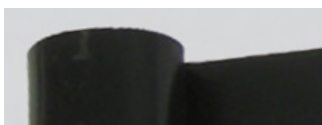

Entretien	Nouvelle couche de peinture tous les 5 à 10 ans.
IMPORTANT	Cette finition est une pré-peinture et nécessite une couche de peinture de finition avant utilisation finale.

Epoxy (RAL)

Définition :

Réalisé par poudrage électrostatique, puis cuit au four. L'épaisseur de peinture déposée (env. 80 µ) sur toute sa surface confère à la pièce une bonne résistance à la corrosion.



Entretien	Nouvelle couche de peinture tous les 5 à 10 ans.
IMPORTANT	Les revêtements peints sont fragiles. Bien veiller à ne pas les entrechoquer afin de ne pas altérer la couche de peinture.

Galvanisation

Définition :

Opération consistant à recouvrir de zinc, un métal ferreux par immersion dans un bain de zinc en fusion.



Entretien	-
IMPORTANT	-

Inox brossé

Définition :

Il s'agit d'un inox qui est mécaniquement brossé pour lui donner cet effet. L'inox brossé est obligatoirement passivé.



Entretien	Ne pas utiliser de produits acides qui risqueraient d'endommager irrémédiablement vos surfaces.
IMPORTANT	La stabilité de la couche passive dépend du milieu extérieur et de la composition de la nuance. Il est donc nécessaire de définir la bonne nuance d'inox adaptée à chaque environnement.

Satiné

Définition :

La finition satinée accroche la lumière et donne un rendu légèrement brillant compris entre 65 et 75 %



Entretien	Nouvelle couche de peinture tous les 5 à 10 ans.
IMPORTANT	Les revêtements peints sont fragiles. Bien veiller à ne pas les entrechoquer afin de ne pas altérer la couche de peinture.

Zingage

Définition :

Procédé électrochimique consistant à déposer une pellicule protectrice de zinc sur un métal par décomposition chimique.



Entretien	Nouvelle couche de peinture tous les 5 à 10 ans.
IMPORTANT	Un produit zingué peut être peint pour protéger la pièce de l'oxydation. Il ne peut être soudé. <i>Il est nécessaire de meuler chaque pièce avant soudure.</i>

NORMES ET TAXES

Le marquage CE

Le marquage CE réglementaire est obligatoire pour la mise sur le marché d'un produit dans tout l'espace économique européen. Il s'agit d'un signe de conformité aux exigences fondamentales des règlements et directives européens en termes de sécurité, de santé publique et de protection des consommateurs. Nos autorisations de marquages CE délivrées par AFNOR Certification apportent la preuve que nos produits sont conformes aux exigences des directives et règlements européens applicable au marquage CE : Quincailleries pour les itinéraires d'évacuation ou des applications de cloisonnement anti-feu et anti-fumées.

AFNOR Certification,
11 rue Francis de Pressensé
F - 93571 La Plaine St Denis Cedex.



La Responsabilité Elargie des Producteurs

La Responsabilité Elargie des Producteurs (REP) est basée sur le fait que les entreprises mettant des produits sur le marché français sont responsables de leur cycle de vie. Dans le cadre de cette nouvelle réglementation et en tant que metteur sur le marché de produits dits « recyclables », le groupe Torbel est soumis aux 3 REP ci-dessous :

- Déchets des Eléments d'Ameublement (DEA) : paumelles et charnières de meuble, poignées...
- Articles de Bricolage et de Jardin (ABJ) : pelles, râpeaux, dévidoirs...
- Produits ou Matériaux de Construction du Bâtiment (PMCB): verrous, crémones, gonds, pentures...

Pour chaque produit mis sur le marché, le producteur verse une éco-contribution à l'éco-organisme auquel il adhère. Cette éco-contribution doit permettre le financement de la collecte, le réemploi et le recyclage des déchets. Il est à noter que :

- Les montants de ces éco-contributions varient en fonction des REP et des éco-organismes,
- Ces éco-contributions pourront, dans certains cas, être refacturées à vos clients.

REP	Le groupe Torbel adhère aux Eco-organismes	Numéro d'identification unique	Mention sur la facture sur chaque ligne de produit	A facturer à votre client
DEA	 GARANTIR LA SECONDE VIE DES PRODUITS	FR018353_10Z9W2	Dont éco-participation de ... €	Oui
PMCB		FR018353_04MMLB	L'éco-contribution est payée par Torbel selon le barème PMCB et ne vous est actuellement pas facturée.	Oui, si elle vous est facturée
ABJ		FR018353_14XJKZ	L'éco-contribution est payée par Torbel selon le barème ABJ et ne vous est actuellement pas facturée.	Non

Conditions générales de vente



Nos Conditions Générales de Vente, qui constituent le socle unique des relations commerciales, sont consultables sur le site internet www.afbat.com ou par l'intermédiaire du présent QR Code.



L'INTÉRIEUR DE L'HABITAT

LA PORTE INTÉRIEURE

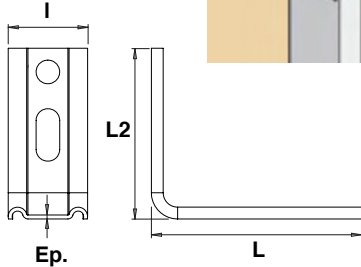
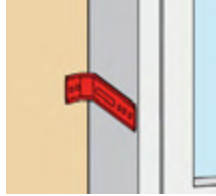

Equerre nervurée droite

Code	Gencod		L	L2	Ep.	I	Nb de trous	Ø de trous	Type packaging	
627200	3221686272001	GALVA.	45	50	1,5	30	0	5,5	Vrac gencodé	25
627205	3221686272056	GALVA.	50	65	1,5	30	0	5,5	Vrac gencodé	25
627210	3221686272100	GALVA.	65	65	1,5	30	1	5,5	Vrac gencodé	25
627215	3221686272155	GALVA.	80	65	1,5	30	2	5,5	Vrac gencodé	25
627220	3221686272209	GALVA.	95	65	1,5	30	3	5,5	Vrac gencodé	25
C627225	3221686272254	GALVA.	110	65	1,5	30	4	5,5	Vrac gencodé	25
C627230	3221686272308	GALVA.	125	65	1,5	30	5	5,5	Vrac gencodé	25
627235	3221686272353	GALVA.	140	65	1,5	30	6	5,5	Vrac gencodé	25

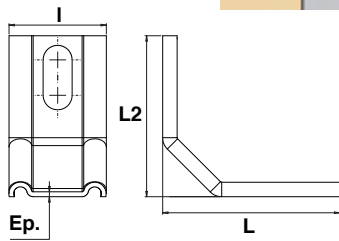
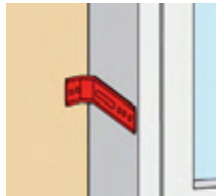

Equerre nervurée 3 pans coupés

Code	Gencod		L	L2	Ep.	I	Nb de trous	Ø de trous	Type packaging	
9925015	3330760024464	GALVA.	55	50	1,5	30	0	5,5	Vrac gencodé	25
0109603	3308181096032	GALVA.	70	55	1,5	30	0	5,5	Vrac gencodé	25
0109703	3308181097039	GALVA.	70	70	1,5	30	1	5,5	Vrac gencodé	25
627160	3221686271608	GALVA.	85	70	1,5	30	2	5,5	Vrac gencodé	25
0109803	3308181098036	GALVA.	100	70	1,5	30	3	5,5	Vrac gencodé	25
627170	3221686271707	GALVA.	115	70	1,5	30	4	5,5	Vrac gencodé	25
0109903	3308181099033	GALVA.	130	70	1,5	30	5	5,5	Vrac gencodé	25
0110003	3308181100036	GALVA.	160	70	1,5	30	7	5,5	Vrac gencodé	25
0942200	3308189422000	GALVA.	55	50	1,5	30	0	5,5		50
0439503	3308184395033	GALVA.	70	55	1,5	30	0	5,5		100
0256800	3308182568002	GALVA.	70	70	1,5	30	1	5,5		100
0256700	3308182567005	GALVA.	100	70	1,5	30	3	5,5		50
0439603	3308184396030	GALVA.	130	70	1,5	30	5	5,5		50
0257200	3308182572009	GALVA.	160	70	1,5	30	7	5,5		30

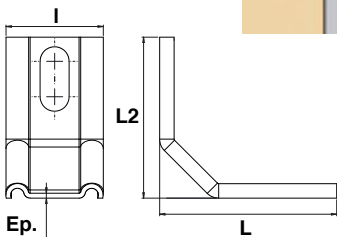

Equerre tronquée renforcée

Code	Gencod		L	L2	Ep.	I	Nb de trous	Ø de trous	Nb de trous	Ø de trous	Type packaging	
6176004	3221686176040	GALVA.	40	70	2	35	6	5,5	1	8,5	Vrac gencodé	20
6176005	3221686176057	GALVA.	50	70	2	35	6	5,5	2	8,5	Vrac gencodé	20
C176007	3221686176071	GALVA.	70	70	2	35	8	5,5	3	8,5	Vrac gencodé	20
6176008	3221686176088	GALVA.	80	70	2	35	10	5,5	3	8,5	Vrac gencodé	20
C176010	3221686176101	GALVA.	100	70	2	35	10	5,5	3	8,5	Vrac gencodé	20
6176012	3221686176125	GALVA.	120	70	2	35	10	5,5	3	8,5	Vrac gencodé	20
C176014	3221686176149	GALVA.	140	70	2	35	10	5,5	4	8,5	Vrac gencodé	20

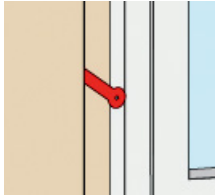

Patte à scellement tête ronde

Code	Gencod		L	I	Ep.	Type packaging	
6134080	3221686134088	GALVA.	80	32	2	Vrac gencodé	25
0247902	3308182479025	GALVA.	100	32	2		1 boîte 100 pièces
0248002	3308182480021	GALVA.	120	32	2		1 boîte 100 pièces
0248102	3308182481028	GALVA.	140	32	2		1 boîte 100 pièces
0251302	3308182513026	GALVA.	160	32	2		1 boîte 50 pièces
0251702	3308182517024	GALVA.	190	32	2		1 boîte 50 pièces
0251902	3308182519028	GALVA.	220	32	2		1 boîte 50 pièces
0730402	3308187304025	GALVA.	100	32	2	Vrac gencodé	25
6134120	3221686134125	GALVA.	120	32	2	Vrac gencodé	25
6134140	3221686134149	GALVA.	140	32	2	Vrac gencodé	25
6134160	3221686134163	GALVA.	160	32	2	Vrac gencodé	25
6134190	3221686134194	GALVA.	190	32	2	Vrac gencodé	25
6134220	3221686134224	GALVA.	220	32	2	Vrac gencodé	25
x10							
6133008	3221686133302	GALVA.	80	32	2	Vrac gencodé	1 sachet 10 pièces
0191100	3308181911007	GALVA.	100	32	2	Vrac gencodé	1 sachet 10 pièces
6133012	3221686133326	GALVA.	120	32	2	Vrac gencodé	1 sachet 10 pièces
6133014	3221686133340	GALVA.	140	32	2	Vrac gencodé	1 sachet 10 pièces
6133016	3221686133364	GALVA.	160	32	2	Vrac gencodé	1 sachet 10 pièces
6133019	3221686133395	GALVA.	190	32	2	Vrac gencodé	1 sachet 10 pièces
0304202	3308183042020	GALVA.	220	32	2		1 boîte 10 sachets 10 pièces

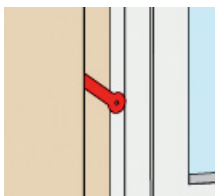

Patte à pointe droite

Code	Gencod		L	Type packaging	
6130060	3221686130066	Z.BLANC	60	Vrac gencodé	25
6130080	3221686130080	Z.BLANC	80	Vrac gencodé	25
6130095	3221686130097	Z.BLANC	100	Vrac gencodé	25
6130125	3221686130127	Z.BLANC	120	Vrac gencodé	25
6130160	3221686130165	Z.BLANC	140	Vrac gencodé	25

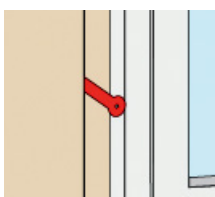

Patte à pointe coudée

Code	Gencod		L	Type packaging	
6131080	3221686131087	Z.BLANC	80	Vrac gencodé	25
6131095	3221686131094	Z.BLANC	100	Vrac gencodé	25
6131125	3221686131124	Z.BLANC	120	Vrac gencodé	25
721890	3026727218907	Z.BLANC	190	Vrac gencodé	10

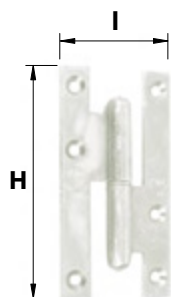

Modèle droite

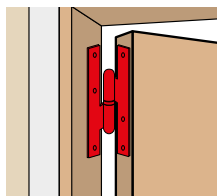

Paumelle de Paris bois bouts carrés

Code	Gencod		H	I	Type packaging	
Droite						
530020	3479045300203	Z.BLANC	80	40	Vrac gencodé	10
530140	3479045301408	Z.BLANC	95	45	Vrac gencodé	10
530280	3479045302801	Z.BLANC	110	55	Vrac gencodé	10
530520	3479045305208	Z.BLANC	140	55	Vrac gencodé	10
530620	3479045306205	Z.BLANC	140	60	Vrac gencodé	10
0366203	3308183662037	Z.BLANC	140	70	Vrac gencodé	10
530880	3479045308803	Z.BLANC	160	60	Vrac gencodé	10
Gauche						
530030	3479045300302	Z.BLANC	80	40	Vrac gencodé	10
530150	3479045301507	Z.BLANC	95	45	Vrac gencodé	10
530290	3479045302900	Z.BLANC	110	55	Vrac gencodé	10
530530	3479045305307	Z.BLANC	140	55	Vrac gencodé	10
530630	3479045306304	Z.BLANC	140	60	Vrac gencodé	10
0366703	3308183667032	Z.BLANC	140	70	Vrac gencodé	10
530890	3479045308902	Z.BLANC	160	60	Vrac gencodé	10

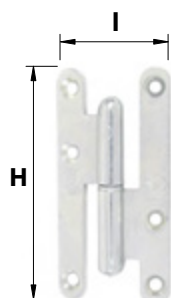

Modèle droite

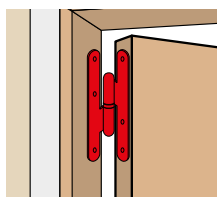

Paumelle de Paris bois bouts ronds

Code	Gencod		H	I	Type packaging	
Droite						
530040	3479045300401	Z.BLANC	80	40	Vrac gencodé	10
530080	3479045300807	Z.BLANC	80	45	Vrac gencodé	10
530160	3479045301606	Z.BLANC	95	45	Vrac gencodé	10
530220	3479045302207	Z.BLANC	110	50	Vrac gencodé	10
530300	3479045303006	Z.BLANC	110	55	Vrac gencodé	10
530380	3479045303808	Z.BLANC	110	60	Vrac gencodé	10
530460	3479045304607	Z.BLANC	110	70	Vrac gencodé	10
530540	3479045305406	Z.BLANC	140	55	Vrac gencodé	10
530640	3479045306403	Z.BLANC	140	60	Vrac gencodé	10
530740	3479045307400	Z.BLANC	140	70	Vrac gencodé	10
9530900	3479045309008	Z.BLANC	160	60	Vrac gencodé	10
Gauche						
530050	3479045300500	Z.BLANC	80	40	Vrac gencodé	10
530090	3479045300906	Z.BLANC	80	45	Vrac gencodé	10
530170	3479045301705	Z.BLANC	95	45	Vrac gencodé	10
530230	3479045302306	Z.BLANC	110	50	Vrac gencodé	10
530330	3479045303303	Z.BLANC	110	55	Vrac gencodé	10
530410	3479045304102	Z.BLANC	110	60	Vrac gencodé	10
530470	3479045304706	Z.BLANC	110	70	Vrac gencodé	10
530570	3479045305703	Z.BLANC	140	55	Vrac gencodé	10
530670	3479045306700	Z.BLANC	140	60	Vrac gencodé	10
530760	3479045307608	Z.BLANC	140	70	Vrac gencodé	10
530910	3479045309107	Z.BLANC	160	60	Vrac gencodé	10

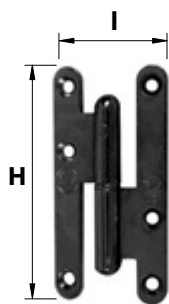

Modèle droite

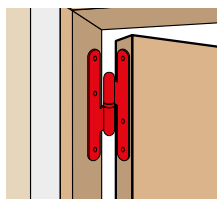

Paumelle de Paris bois bouts ronds

Code	Gencod		H	I	Type packaging	
Droite						
0965106	3308189651066		80	45	Vrac gencodé	10
0965306	3308189653060		110	55	Vrac gencodé	10
0965506	3308189655064		140	60	Vrac gencodé	10
Gauche						
0965206	3308189652063		80	45	Vrac gencodé	10
0965406	3308189654067		110	55	Vrac gencodé	10
0965606	3308189656061		140	60	Vrac gencodé	10

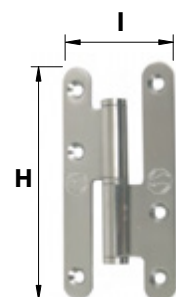

Modèle droite

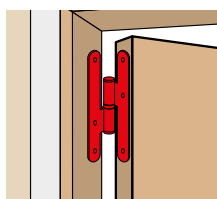

Paumelle de Paris bois inox bouts ronds

Code	Gencod		H	I	Type packaging	
Droite						
532320	3479045323202	INOX 304	110	55	Vrac gencodé	10
532330	3479045323301	INOX 304	140	55	Vrac gencodé	10
532340	3479045323400	INOX 304	140	70	Vrac gencodé	10
532350	3479045323509	INOX 304	160	80	Vrac gencodé	10
Gauche						
532325	3479045323257	INOX 304	110	55	Vrac gencodé	10
532335	3479045323356	INOX 304	140	55	Vrac gencodé	10
532345	3479045323455	INOX 304	140	70	Vrac gencodé	10
532355	3479045323554	INOX 304	160	80	Vrac gencodé	10

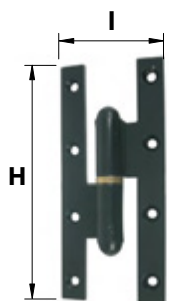

Modèle gauche

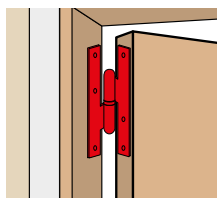

Paumelle Picarde

Code	Gencod		H	I	Type packaging	
Droite						
537140	3221685371408		140	60	Vrac gencodé	10
537160	3221685371606		160	70	Vrac gencodé	10
537190	3221685371903		190	70	Vrac gencodé	10
537220	3221685372207		220	80	Vrac gencodé	10
Gauche						
537150	3221685371507		140	60	Vrac gencodé	10
537170	3221685371705		160	70	Vrac gencodé	10
9537200	3221685372009		190	70	Vrac gencodé	10
537230	3221685372306		220	80	Vrac gencodé	10

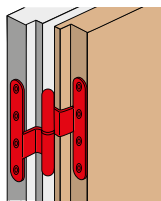
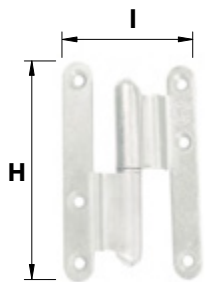

Modèle gauche

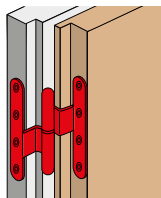
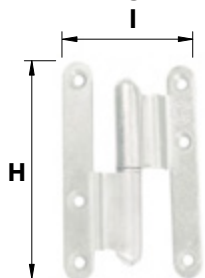

Modèle gauche

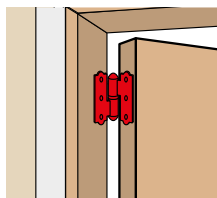
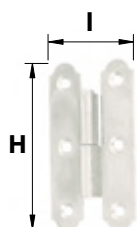

Modèle droite

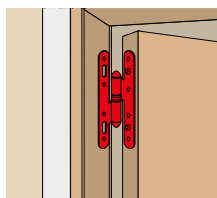
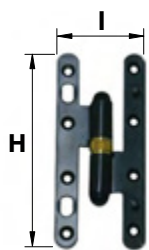

Modèle droite

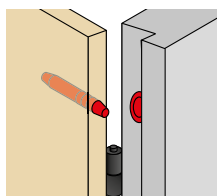
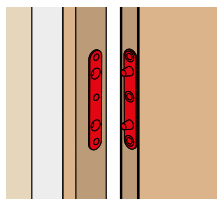
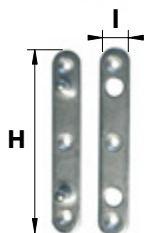
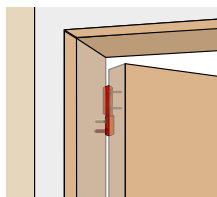
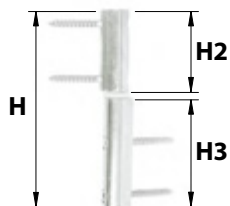

Paumelle bois coudée à 90° bouts ronds

Code	Gencod		H	I	Dép.	Type packaging	
Droite							
532630	3479045326302	Z.BLANC	110	42,5	20	Vrac gencodé	10
Gauche							
532660	3479045326609	Z.BLANC	110	42,5	20	Vrac gencodé	10

Paumelle bois coudée à 100° bouts ronds

Code	Gencod		H	I	Dép.	Type packaging	
Droite							
532920	3479045329204	Z.BLANC	140	49	20	Vrac gencodé	10
Gauche							
532930	3479045329303	Z.BLANC	140	49	20	Vrac gencodé	10

Paumelle espagnole

Code	Gencod		H	I	Type packaging	
Droite						
535880	3479045358808	Z.BLANC	68	43	Vrac gencodé	
9535900	3479045359003	Z.BLANC	78	45	Vrac gencodé	10
0970503	3308189705035	Z.BLANC	88	46	Vrac gencodé	
Gauche						
535890	3479045358907	Z.BLANC	68	43	Vrac gencodé	
535910	3479045359102	Z.BLANC	78	45	Vrac gencodé	10
0970603	3308189706032	Z.BLANC	88	46	Vrac gencodé	

Paumelle de sécurité

Code	Gencod		H	I	Type packaging	
Antisoulèvement - Droite						
0706200	3308187062000		160	70	Brochable gencodé	1
Antisoulèvement - Gauche						
0706100	3308187061003		160	70	Brochable gencodé	1

Paumelle Profix®

Code	Gencod		H	H2	H3	Type packaging	
534840	3479045348403	Z.BLANC	85	50	35	Vrac gencodé	
534850	3479045348502	Z.BLANC	100	57	40	Vrac gencodé	10

Renfort de paumelle platine (x2)

Code	Gencod		H	I	Ep.	Type packaging	
0896100	3308188961005	Z.BLANC	125	20	4	Brochable gencodé	1 sachet 2 pièces

Renfort de paumelle goujon + douille (x4)

Code	Gencod		L	D Noeud	D Axe	Type packaging	
0236400	3308182364000	Z.BLANC	50,5	11	15	Brochable gencodé	1 sachet 4 pièces

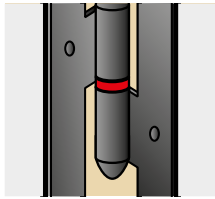

Bague de paumelle

Code	Gencod		D Ext.	D Int.	Ep.	Type packaging	
x6							
546945	3221685469457	LAITON	11	6,1	1,75	Brochable gencodé	1 sachet 6 pièces
546946	3221685469464	LAITON	12	6,5	2	Brochable gencodé	1 sachet 6 pièces
546948	3221685469488	LAITON	13	6,5	2	Brochable gencodé	1 sachet 6 pièces
546947	3221685469471	LAITON	13,2	7	2	Brochable gencodé	1 sachet 6 pièces
547016	3221685470163	LAITON	14	7,1	2	Brochable gencodé	1 sachet 6 pièces
547017	3221685470170	LAITON	14	8	3	Brochable gencodé	1 sachet 6 pièces
547018	3221685470187	LAITON	15,5	8,5	3,5	Brochable gencodé	1 sachet 6 pièces
547019	3221685470194	LAITON	17,8	9	4	Brochable gencodé	1 sachet 6 pièces
547020	3221685470200	LAITON	19	9,5	4	Brochable gencodé	1 sachet 6 pièces
x9							
597012	3221685970120	LAITON	12	6,2	1,75 (x3)	Brochable gencodé	1 sachet 9 pièces
		LAITON	13	6,2	2 (x3)		
		LAITON	14	7,1	2 (x3)		

NOUVEAU

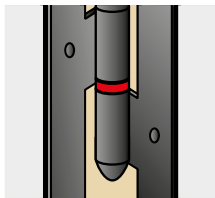

Bague de paumelle antibruit

Code	Gencod		D Ext.	D Int.	Ep.	Type packaging	
547025	3517655470258		13	6,5	1	Brochable gencodé	1 sachet 24 pièces
547026	3517655470265		14	8,5	1	Brochable gencodé	1 sachet 24 pièces

Fiches

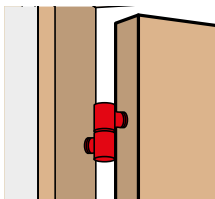

Fiche à visser standard

Code	Gencod		H	D	Type packaging	
542730	3479045427306	Z.BLANC	26	5,7	Vrac gencodé	12
542750	3479045427504	Z.BLANC	28	6,2	Vrac gencodé	12
542710	3479045427108	Z.BLANC	35	7,5	Vrac gencodé	12
542770	3479045427702	Z.BLANC	40	7,5	Vrac gencodé	12
542830	3479045428303	Z.BLANC	55	8,5	Vrac gencodé	12

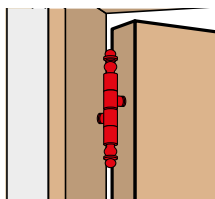

Fiche à visser style

Code	Gencod		H	D	Type packaging	
542970	3479045429706	BRONZÉ	93	7,8	Vrac gencodé	50

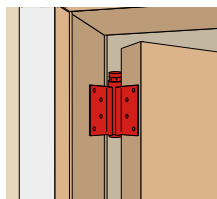
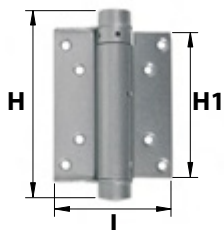

Charnière à ressort simple action

Code	Gencod		H	H1	I	Type packaging	
0746200	3308187462008		122,5	93	78	Brochable gencodé	1
9630000	3221686300001		122,5	93	78	Vrac gencodé	1 sachet 2 pièces

Charnière à ressort double action

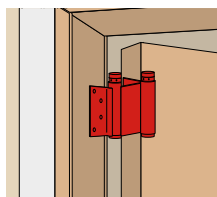
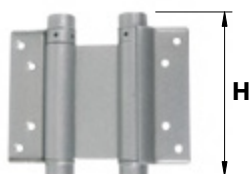

Code	Gencod		H	Type packaging	
Petit modèle - 75 mm					
0746000	3308187460004		75	Brochable gencodé	1
630001	3221686300018		75	Vrac gencodé	1 sachet 2 pièces
Grand modèle - 100 mm					
0746100	3308187461001		100	Brochable gencodé	1
630002	3221686300025		100	Vrac gencodé	1 sachet 2 pièces

Ferrures portes métalliques

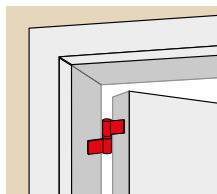
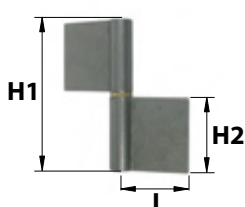

Paumelle de grille à souder

Code	Gencod		H1	H2	I	D Axe	D Noeud	Ep.	Type packaging	
535820	3479045358204	BRUT	80	38,5	47,5	9	15	4	Vrac gencodé	12
535840	3479045358402	BRUT	100	48,0	54,3	10	16,5	5,1	Vrac gencodé	12
535850	3479045358501	BRUT	120	58	63	11	18,5	6,1	Vrac gencodé	12
535860	3479045358600	BRUT	120	68	63	11	18,5	6,1	Vrac gencodé	12
0445300	3308184453009	BRUT	80	38,5	47,5	9	15	4		
0445000	3308184450008	BRUT	100	48	54,3	10	16,5	5,1		1 boîte 10 pièces

Paumelle sans lame PROFILSOUD®

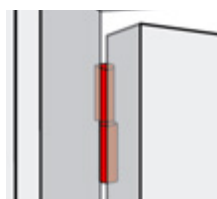
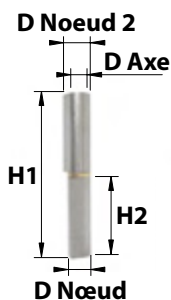

Code	Gencod		H1	H2	D Axe	D Noeud	D Noeud 2	Type packaging	
544310	3479045443108	BRUT	60	30	7	13	16	Vrac gencodé	12
544320	3479045443207	BRUT	80	39,2	7	16	20	Vrac gencodé	12
544330	3479045443306	BRUT	100	49,5	9	16	20	Vrac gencodé	12
544340	3479045443405	BRUT	120	59,5	9	20	25	Vrac gencodé	12
544350	3479045443504	BRUT	140	69,3	11	20	25	Vrac gencodé	12
544360	3479045443603	BRUT	160	79,3	14	23	29	Vrac gencodé	12
544370	3479045443702	BRUT	180	89,2	14	23	29	Vrac gencodé	12
0445600	3308184456000	BRUT	140	69,3	11	20	25		1 boîte 20 pièces

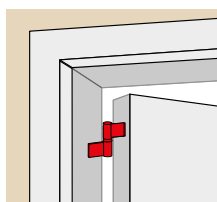
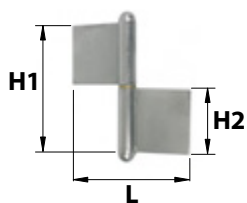

Paumelle de grille à souder

Code	Gencod		H1	H2	L	D Axe	D Nœud	Ep.	Type packaging	
535130	3479045351304	BLANCHI	60	30	72	5,9	12	3	Vrac gencodé	12
535150	3479045351502	BLANCHI	80	40	93	6,9	13	3	Vrac gencodé	12
535170	3479045351700	BLANCHI	100	50	115	6,9	16	3,5	Vrac gencodé	12
535200	3479045352004	BLANCHI	120	60	120	6,9	21	3,5	Vrac gencodé	12

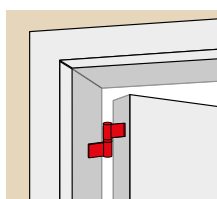
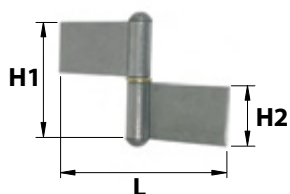

Paumelle de grille à souder extra-forte

Code	Gencod		H1	H2	L	D Axe	D Nœud	Ep.	Type packaging	
535680	3479045356804	BLANCHI	80	40	140,6	10	13	4	Vrac gencodé	12
535700	3479045357009	BLANCHI	100	50	164	11	16	5	Vrac gencodé	12
535720	3479045357207	BLANCHI	120	60	164	11	21	5	Vrac gencodé	12

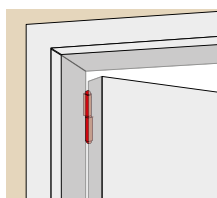
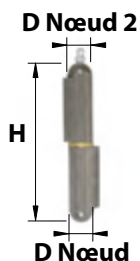

Paumelle à souder bout rond + graisseur

Code	Gencod		H	D Nœud	D Nœud 2	D Axe	Type packaging	
9544400	3221685444003	Z.BLANC	100	16	20	9	Vrac gencodé	20
9544402	3221685444027	Z.BLANC	120	16	20	9	Vrac gencodé	

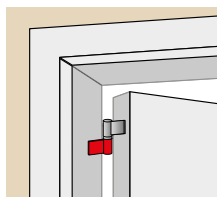

Lame mâle mixte

Code	Gencod		L	Type packaging	
534280	3479045342807	Z.BLANC	100	Vrac gencodé	12
534290	3479045342906	Z.BLANC	120	Vrac gencodé	12

Judas

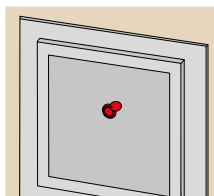
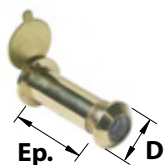

Judas optique

Code	Gencod		D	Ep.	Angle	Type packaging	
160° - Ø12 mm - 3 lentilles							
0995800	3308189958004	NICKELÉ	12	25/63	160°	Brochable gencodé	1

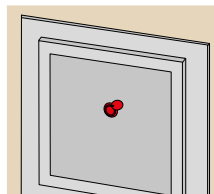

Judas optique

Code	Gencod		D	Ep.	Angle	Type packaging	
200° - Ø40 à 55 mm - 1 lentille							
0995900	3308189959001	NICKELÉ	12	25/63	200°	Brochable gencodé	1

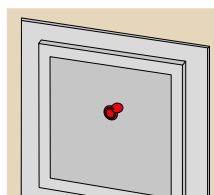
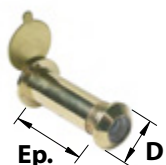

Judas optique

Code	Gencod		D	Ep.	Angle	Type packaging	
160° - Ø12 mm - 3 lentilles							
0996000	3308189960007	NICKELÉ	12	33/63	160°	Brochable gencodé	1

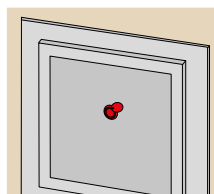

Judas optique

Code	Gencod		D	Ep.	Angle	Type packaging	
190° - Ø14 mm - 4 lentilles							
0996100	3308189961004	NICKELÉ	14	26/80	200°	Brochable gencodé	1

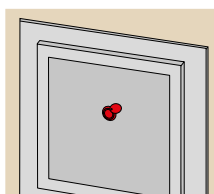
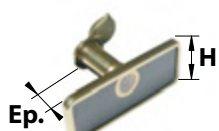

Judas porte-nom

Code	Gencod		D	Ep.	Angle	Type packaging	
0996200	3308189962001	NICKELÉ	12	25/63	160°	Brochable gencodé	1

Arrêts de porte

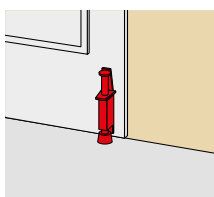

Fixe-porte à pédale

Code	Gencod		H	Type packaging	
0823100	3308180040470		130	Brochable gencodé	1
0745800	3308187458001	Z.BLANC	180	Brochable gencodé	1
630031	3221686300315		130	Brochable gencodé	1
0745900	3308187459008		180	Brochable gencodé	1

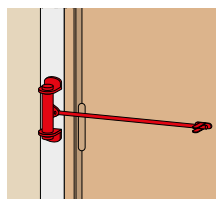
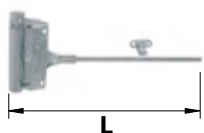

Ferme-porte ajustable

Code	Gencod		L	Type packaging	
Bras L240 mm - Charge max. 40 kg					
0745200	3308187452009		240	Brochable gencodé	1
Bras L340 mm - Charge max. 80 kg					
0745400	3308187454003		340	Brochable gencodé	1

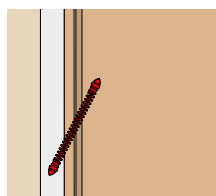

Ferme-porte ressort spirale

Code	Gencod		L	Type packaging	
Charge max. 40 kg					
0745504	3308187455048		222	Brochable gencodé	1
0745500	3308187455000	Z.BLANC	222	Brochable gencodé	1
Charge max. 80 kg					
0745604	3308187456045		283	Brochable gencodé	1
0745600	3308187456007	Z.BLANC	283	Brochable gencodé	1

Gâches

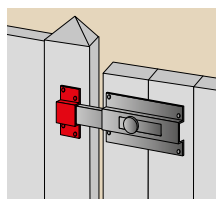
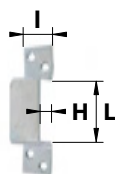

Gâche pour pêne rectangulaire

Code	Gencod		L	I	H	Ep	Type packaging	
0100101	3308181001012		45	25	20	2	Vrac gencodé	10
6116035	3221686116350	Z.BLANC	35	25	20	2	Vrac gencodé	10
6116040	3221686116404	Z.BLANC	40	25	20	2	Vrac gencodé	10
6116045	3221686116459	Z.BLANC	45	25	20	2	Vrac gencodé	10
6116050	3221686116503	Z.BLANC	50	25	20	2	Vrac gencodé	10
6116055	3221686116558	Z.BLANC	55	25	20	2	Vrac gencodé	10
6116060	3221686116602	Z.BLANC	60	25	20	2	Vrac gencodé	10
6116080	3221686116800	Z.BLANC	80	25	20	2	Vrac gencodé	10
6116100	3221686116107	Z.BLANC	100	25	20	2	Vrac gencodé	10

Verrous

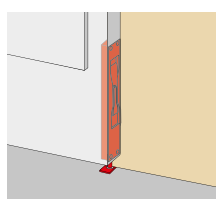
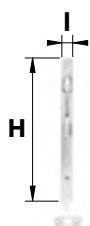

Verrou de porte à levier

Code	Gencod		H	I	Type packaging	
9544100	3479045441005	Z.BLANC	150	11	Vrac gencodé	10
544110	3479045441104	Z.BLANC	200	11	Vrac gencodé	10

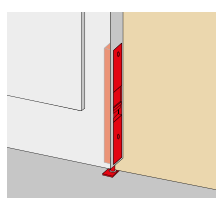
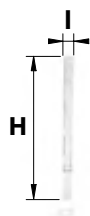

Verrou de porte à entailler

Code	Gencod		H	I	Type packaging	
544020	3479045440206	Z.BLANC	200	11	Vrac gencodé	10

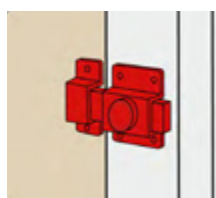
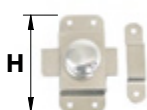

Verrou automatique à bouton

Code	Gencod		H	Type packaging	
507183	3221685071834	NICHELÉ	30	Vrac gencodé	10

Soumis à éco-participation Mobilier.

Targettes

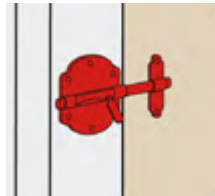
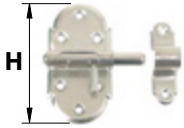
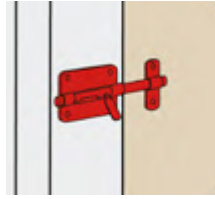

Boutons

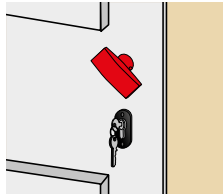
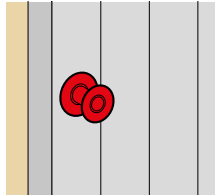
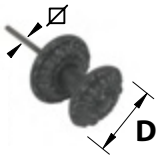

Chaînettes

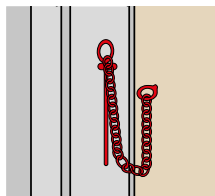
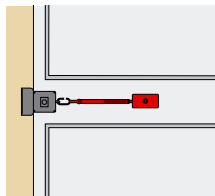

Targette à pêne rond

Code	Gencod		H	Type packaging	
Platine rectangulaire 4 trous					
504986	3221685049864		25	Vrac gencodé	1
504988	3221685049888		35	Vrac gencodé	1
504982	3221685049826	NICKELÉ	25	Vrac gencodé	10
504984	3221685049840	NICKELÉ	35	Vrac gencodé	10

Soumis à éco-participation Mobilier.

Targette à pêne rond

Code	Gencod		H	Type packaging	
Platine festonnée 6 trous					
504994	3221685049949	NICKELÉ	35	Vrac gencodé	1
504996	3221685049963	NICKELÉ	40	Vrac gencodé	1

Soumis à éco-participation Mobilier.

Bouton de porte double Dahlia + tige

Code	Gencod			D	Type packaging	
503005	3308185030056			6	70	Vrac gencodé 1

Bouton de porte double N°102 + tige

Code	Gencod			Type packaging	
502182	3479045021825	APPRET		Vrac gencodé	6

Chaînette de porte fonte



Code	Gencod		Course	Type packaging	
503006	3479045030063		190 à 280 mm	Vrac gencodé	1

Chaînette épinglette

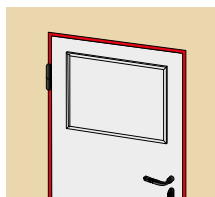
Code	Gencod		Type packaging	
183011	3430831830113	LAITONNÉ	Vrac gencodé	20



Cornière anti-effraction

Code	Gencod		L	Type packaging	
Porte d'entrée L1,20 m					
0705503	3308187055033	Z.BLANC	1200	Vrac gencodé	1
Porte d'entrée L2,35 m					
0678936	3308186789366	8016	2350	Vrac gencodé	1

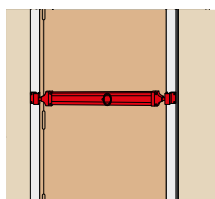





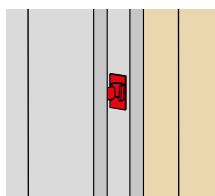



Barre de sécurité à serrure 2 points

Code	Gencod		L	Type packaging	
0754300	3308180031287		920	Brochable gencodé	1



Arrêt à pince

Code	Gencod		H	Type packaging	
0954500	3308189545006		50	Brochable gencodé	1
105070	3221681050703		50	Vrac gencodé	1
105076	3221681050765		50	Brochable gencodé	1
105075	3221681050758		50	Vrac gencodé	1
0954600	3308189546003		50	Brochable gencodé	1
105080	3221681050802		50	Vrac gencodé	1







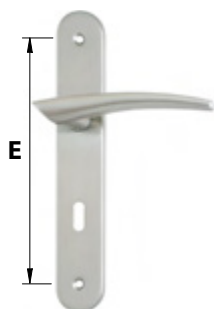



L'INTÉRIEUR DE L'HABITAT

LA POIGNÉE DE PORTE







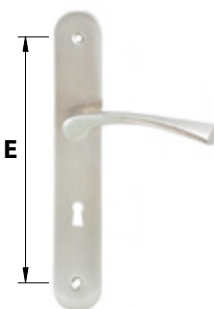



Ensemble sur plaque SYDNEY

Code	Gencod		E	Ressort de rappel	Type de perçement	Type packaging	
1082700	3308180108279	NICKELÉ S.	195	-		Brochable gencodé	1
1082800	3308180108286	NICKELÉ S.	195			Brochable gencodé	1
1082900	3308180108293	NICKELÉ S.	195			Brochable gencodé	1
1083000	3308180108309	NICKELÉ S.	195			Brochable gencodé	1







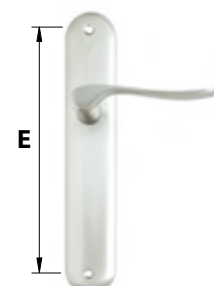



Ensemble sur plaque TORONTO

Code	Gencod		E	Ressort de rappel	Type de perçement	Type packaging	
1083100	3308180108316	NICKELÉ S.	195	-		Brochable gencodé	1
1083200	3308180108323	NICKELÉ S.	195			Brochable gencodé	1
1083300	3308180108330	NICKELÉ S.	195			Brochable gencodé	1
1083400	3308180108347	NICKELÉ S.	195			Brochable gencodé	1



Ensemble sur plaque HOSSEGOR

Code	Gencod		E	Ressort de rappel	Type de perçement	Type packaging	
1083900	3308180108392	NICKELÉ S.	195	-		Brochable gencodé	1
1084000	3308180108408	NICKELÉ S.	195			Brochable gencodé	1
1084100	3308180108415	NICKELÉ S.	195			Brochable gencodé	1
1084200	3308180108422	NICKELÉ S.	195			Brochable gencodé	1

PERCEMENTS

				
Bec de cane	Clé L	Cylindre ou clé I	Condannation (G ou D)	Décondannation

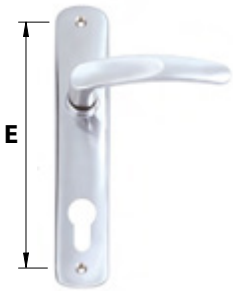

Ensemble sur plaque VENICE

Code	Gencod		E	Ressort de rappel	Type de perçement	Type packaging	
1084700	3308180108477	CHROME	165	-		Brochable gencodé	1
1084800	3308180108484	CHROME	165	-		Brochable gencodé	1
1084900	3308180108491	CHROME	165	-		Brochable gencodé	1
1085000	3308180108507	CHROME	165	-		Brochable gencodé	1



Ensemble sur plaque GRASSE

Code	Gencod		E	Ressort de rappel	Type de perçement	Type packaging	
1085100	3308180108514	CHROME	165	-		Brochable gencodé	1
1085200	3308180108521	CHROME	165	-		Brochable gencodé	1
1085300	3308180108538	CHROME	165	-		Brochable gencodé	1
1085400	3308180108545	CHROME	165	-		Brochable gencodé	1

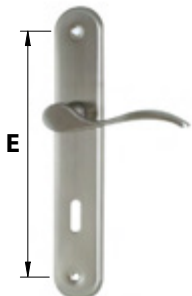

Ensemble sur plaque PICCADILLY

Code	Gencod		E	Ressort de rappel	Type de perçement	Type packaging	
1085500	3308180108552	NICKELÉ S.	195	-		Brochable gencodé	1
1085600	3308180108569	NICKELÉ S.	195			Brochable gencodé	1
1085700	3308180108576	NICKELÉ S.	195			Brochable gencodé	1
1085800	3308180108583	NICKELÉ S.	195			Brochable gencodé	1

PERCEMENTS

Bec de cane	Clé L	Cylindre ou clé I	Condamnation (G ou D)	Décondamnation

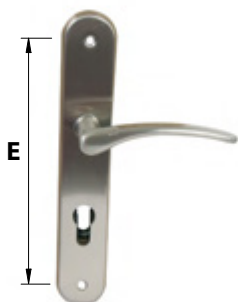

Ensemble sur plaque OSTENDE

Code	Gencod		E	Ressort de rappel	Type de perçement	Type packaging	
1085900	3308180108590	NICKELÉ S.	195	-		Brochable gencodé	1
1086000	3308180108606	NICKELÉ S.	195			Brochable gencodé	1
1086100	3308180108613	NICKELÉ S.	195			Brochable gencodé	1
1086200	3308180108620	NICKELÉ S.	195			Brochable gencodé	1

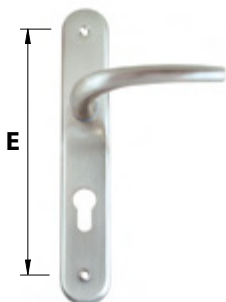

Ensemble sur plaque NEWPORT

Code	Gencod		E	Ressort de rappel	Type de perçement	Type packaging	
1086300	3308180108637	NICKELÉ S.	195	-		Brochable gencodé	1
1086400	3308180108644	NICKELÉ S.	195			Brochable gencodé	1
1086500	3308180108651	NICKELÉ S.	195			Brochable gencodé	1
1086600	3308180108668	NICKELÉ S.	195			Brochable gencodé	1

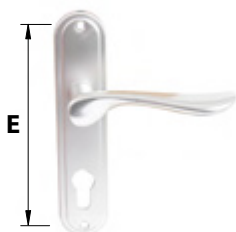

Ensemble sur plaque ALHAMBRA







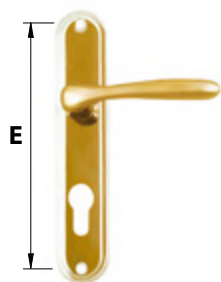

Code	Gencod		E	Ressort de rappel	Type de perçement	Type packaging	
1081500	3308180108156	LAITONNÉ POLI	165	-		Brochable gencodé	1
1081600	3308180108163	LAITONNÉ POLI	165			Brochable gencodé	1
1081700	3308180108170	LAITONNÉ POLI	165			Brochable gencodé	1
1081800	3308180108187	LAITONNÉ POLI	165			Brochable gencodé	1

PERCEMENTS

Bec de cane	Clé L	Cylindre ou clé I	Condamnation (G ou D)	Décondamnation







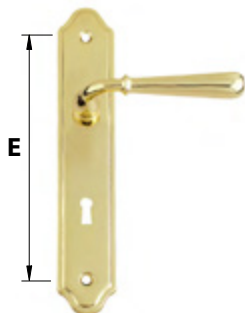

Ensemble sur plaque TREVI

Code	Gencod		E	Ressort de rappel	Type de perçement	Type packaging	
1081900	3308180108194	NICKELÉ S.	165	-		Brochable gencodé	1
1082000	3308180108200	NICKELÉ S.	165			Brochable gencodé	1
1082100	3308180108217	NICKELÉ S.	165			Brochable gencodé	1
1082200	3308180108224	NICKELÉ S.	165			Brochable gencodé	1







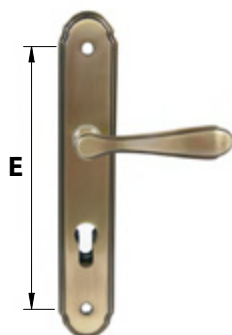

Ensemble sur plaque BEAUGENCY

Code	Gencod		E	Ressort de rappel	Type de perçement	Type packaging	
1084300	3308180108439	LAITONNÉ POLI	195	-		Brochable gencodé	1
1084400	3308180108446	LAITONNÉ POLI	195	-		Brochable gencodé	1
1084500	3308180108453	LAITONNÉ POLI	195	-		Brochable gencodé	1
1084600	3308180108460	LAITONNÉ POLI	195	-		Brochable gencodé	1



Ensemble sur plaque VILLANDRY

Code	Gencod		E	Ressort de rappel	Type de perçement	Type packaging	
1083500	3308180108354	LAITONNÉ VIEILLI	195	-		Brochable gencodé	1
1083600	3308180108361	LAITONNÉ VIEILLI	195	-		Brochable gencodé	1
1083700	3308180108378	LAITONNÉ VIEILLI	195	-		Brochable gencodé	1
1083800	3308180108385	LAITONNÉ VIEILLI	195	-		Brochable gencodé	1

PERCEMENTS

				
Bec de cane	Clé L	Cylindre ou clé I	Condamnation (G ou D)	Décondamnation



Ensemble sur rosace ronde SAINT-ANDREWS

Code	Gencod		Ressort de rappel	Type packaging	
1088300	3308180108835	NICKELÉ S.		Brochable gencodé	1



2 rosaces de fonction rondes SAINT-ANDREWS

Code	Gencod		Type de perçement	Type packaging	
1088400	3308180108842	NICKELÉ S.		Brochable gencodé	1
1088500	3308180108859	NICKELÉ S.		Brochable gencodé	1
1088600	3308180108866	NICKELÉ S.		Brochable gencodé	1



Ensemble sur rosace ronde INDIANAPOLIS

Code	Gencod		Ressort de rappel	Type packaging	
1089900	3308180108996	NICKELÉ S.		Brochable gencodé	1



2 rosaces de fonction ronde INDIANAPOLIS

Code	Gencod		Type de perçement	Type packaging	
1090000	3308180109009	NICKELÉ S.		Brochable gencodé	1
1090100	3308180109016	NICKELÉ S.		Brochable gencodé	1
1090200	3308180109023	NICKELÉ S.		Brochable gencodé	1



Ensemble sur rosace ronde CLUNY

Code	Gencod		Ressort de rappel	Type packaging	
1090300	3308180109030			Brochable gencodé	1



2 rosaces de fonction rondes CLUNY

Code	Gencod		Type de perçement	Type packaging	
1090400	3308180109047			Brochable gencodé	1
1090500	3308180109054			Brochable gencodé	1
1090600	3308180109061			Brochable gencodé	1

PERCEMENTS

Bec de cane	Clé L	Cylindre ou clé I	Condamnation (G ou D)	Décondamnation

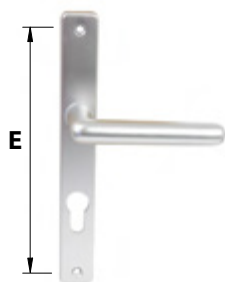

Ensemble sur plaque étroite COLUMBUS

Code	Gencod		E	Ressort de rappel	Type de perçement	Type packaging	
1092300	3308180109238	ARGENT	195	-		Brochable gencodé	1
1092400	3308180109245	ARGENT	195	-		Brochable gencodé	1
1092500	3308180109252	ARGENT	195	-		Brochable gencodé	1
1092600	3308180109269	ARGENT	195	-		Brochable gencodé	1

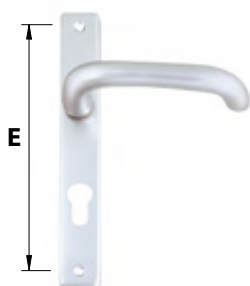

Ensemble sur plaque étroite TUCSON

Code	Gencod		E	Ressort de rappel	Type de perçement	Type packaging	
1093100	3308180109313	ARGENT	195	-		Brochable gencodé	1
1093200	3308180109320	ARGENT	195	-		Brochable gencodé	1
1093300	3308180109337	ARGENT	195	-		Brochable gencodé	1
1093400	3308180109344	ARGENT	195	-		Brochable gencodé	1

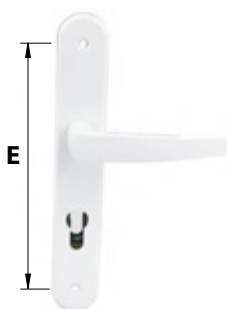

Ensemble sur plaque étroite PORTLAND

Code	Gencod		E	Ressort de rappel	Type de perçement	Type packaging	
1093500	3308180109351	LAQUÉ	195	-		Brochable gencodé	1
1093600	3308180109368	LAQUÉ	195			Brochable gencodé	1
1093700	3308180109375	LAQUÉ	195			Brochable gencodé	1
1093800	3308180109382	LAQUÉ	195			Brochable gencodé	1

PERCEMENTS

Bec de cane	Clé L	Cylindre ou clé I	Condamnation (G ou D)	Décondamnation

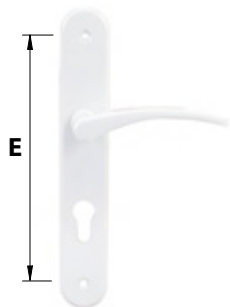

Ensemble sur plaque BOSTON

Code	Gencod	Entraxe	Ressort de rappel	Type de perçement	Type packaging	
1123700	3308180112375	LAQUÉ	195	-	Brochable gencodé	1
1123800	3308180112382	LAQUÉ	195		Brochable gencodé	1
1123900	3308180112399	LAQUÉ	195		Brochable gencodé	1
1124000	3308180112405	LAQUÉ	195		Brochable gencodé	1

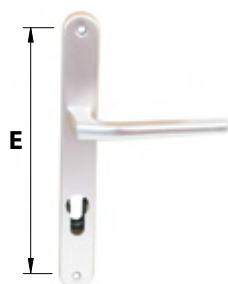

Ensemble sur plaque OPIO

Code	Gencod	Entraxe	Ressort de rappel	Type de perçement	Type packaging	
1091500	3308180109153	ARGENT	195	-	Brochable gencodé	1
1091600	3308180109160	ARGENT	195	-	Brochable gencodé	1
1091700	3308180109177	ARGENT	195	-	Brochable gencodé	1
1091800	3308180109184	ARGENT	195	-	Brochable gencodé	1



Ensemble sur plaque MEDICIS

Code	Gencod	Entraxe	Ressort de rappel	Type de perçement	Type packaging	
1090700	3308180109078	■	195	-	Brochable gencodé	1
1090800	3308180109085	■	195	-	Brochable gencodé	1
1090900	3308180109092	■	195	-	Brochable gencodé	1
1091000	3308180109108	■	195	-	Brochable gencodé	1

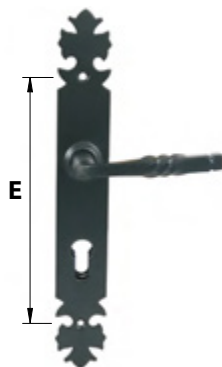

Ensemble sur plaque GUEDELON

Code	Gencod	Entraxe	Ressort de rappel	Type de perçement	Type packaging	
1091100	3308180109115	■	195	-	Brochable gencodé	1
1091200	3308180109122	■	195	-	Brochable gencodé	1
1091300	3308180109139	■	195	-	Brochable gencodé	1
1091400	3308180109146	■	195	-	Brochable gencodé	1

PERCEMENTS

Bec de cane	Clé L	Cylindre ou clé I	Condamnation (G ou D)	Décondamnation



Ensemble sur rosace ronde TOLEDO

Code	Gencod		Ressort de rappel	Type packaging	
1124700	3308180112474	<input type="text"/>	-	Brochable gencodé	1

2 rosaces de fonction rondes TOLEDO

Code	Gencod		Type de percement	Type packaging	
1124800	3308180112481	<input type="text"/>		Brochable gencodé	1
1124900	3308180112498	<input type="text"/>		Brochable gencodé	1
1125000	3308180112504	<input type="text"/>		Brochable gencodé	1



Ensemble sur rosace ronde TUCSON

Code	Gencod		Ressort de rappel	Type packaging	
1125200	3308180112528	ARGENT	-	Brochable gencodé	1

2 rosaces de fonction rondes TUCSON

Code	Gencod		Type de percement	Type packaging	
1125400	3308180112542	NICKELÉ S.		Brochable gencodé	1
1125500	3308180112559	NICKELÉ S.		Brochable gencodé	1
1125600	3308180112566	NICKELÉ S.		Brochable gencodé	1





PERCEMENTS

Bec de cane	Clé L	Cylindre ou clé I	Condamnation (G ou D)	Décondamnation





Béquille double PORTLAND

Code	Gencod		Type packaging	
1125700	3308180112573		Brochable gencodé	1



Bouton double PORTLAND

Code	Gencod		Type packaging	
1125800	3308180112580		Brochable gencodé	1



Béquille double PORTLAND

Code	Gencod		Type packaging	
1126200	3308180112627	ARGENT	Brochable gencodé	1





Bouton double PORTLAND

Code	Gencod		Type packaging	
1126300	3308180112634	ARGENT	Brochable gencodé	1





Béquille double torsadée

Code	Gencod		Type packaging	
1126500	3308180112658		Brochable gencodé	1





Bouton double OVO

Code	Gencod		Type packaging	
1126600	3308180112665	CHROME	Brochable gencodé	1





Poignée de fenêtre PORTLAND

Code	Gencod		Type packaging 
1125900	3308180112597	<input type="text"/>	Brochable gencodé 1





Bouton de fenêtre PORTLAND

Code	Gencod		Type packaging 
1126000	3308180112603	<input type="text"/>	Brochable gencodé 1





Bouton de fenêtre PORTLAND

Code	Gencod		Type packaging 
1126400	3308180112641	CHROME	Brochable gencodé 1



Poignée de fenêtre oscillobattante CLEVELAND

Code	Gencod		Type packaging 
1126100	3308180112610	<input type="text"/>	Brochable gencodé 1



Poignée de fenêtre MANDELIEU

Code	Gencod		Type packaging
1126800	3308180112689	ARGENT	Brochable gencodé 1



Bouton de fenêtre PUGET

Code	Gencod		Type packaging
1126900	3308180112696	ARGENT	Brochable gencodé 1



Bouton de fenêtre NEWPORT

Code	Gencod		Type packaging
1127000	3308180112702	ARGENT	Brochable gencodé 1



Poignée de fenêtre oscillobattante CARROS

Code	Gencod		Type packaging
1127100	3308180112719	ARGENT	Brochable gencodé 1



Poignée de fenêtre oscillobattante

Code	Gencod		Type packaging
1126700	3308180112672	CHAMPAGNE	Brochable gencodé 1



Poignée de fenêtre oscillobattante NEWPORT

Code	Gencod		Type packaging
1127300	3308180112733	CHAMPAGNE	Brochable gencodé 1



Demi-ensemble sur plaque entrée inox

Code	Gencod	Entraxe	Type packaging
1127600	3308180112764	195	Brochable gencodé

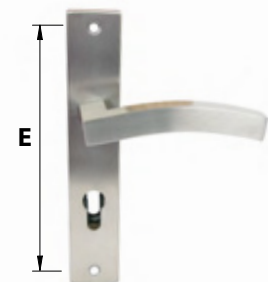

Ensemble sur plaque DETROIT

Code	Gencod	Entraxe	Ressort de rappel	Type de perçement	Type packaging
1127700	3308180112771	195	-		Brochable gencodé
1127800	3308180112788	195			Brochable gencodé
1127900	3308180112795	195			Brochable gencodé
1128000	3308180112801	195			Brochable gencodé

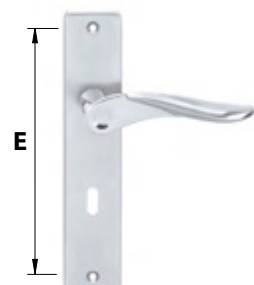

Ensemble sur plaque BALTIMORE

Code	Gencod	Entraxe	Ressort de rappel	Type de perçement	Type packaging
1130900	3308180113099	195	-		Brochable gencodé
1131000	3308180113105	195			Brochable gencodé
1131100	3308180113112	195			Brochable gencodé
1131200	3308180113129	195			Brochable gencodé

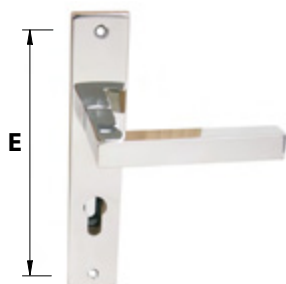

Ensemble sur plaque SEATTLE

Code	Gencod	Entraxe	Ressort de rappel	Type de perçement	Type packaging
1131700	3308180113174	195	-		Brochable gencodé
1131800	3308180113181	195			Brochable gencodé
1131900	3308180113198	195			Brochable gencodé
1132000	3308180113204	195			Brochable gencodé

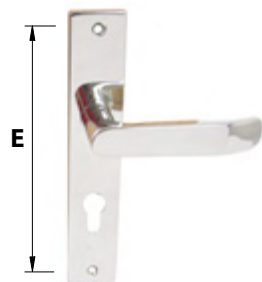

Ensemble sur plaque DALLAS

Code	Gencod	Entraxe	Ressort de rappel	Type de perçement	Type packaging
1132900	3308180113297	195	-		Brochable gencodé
1133000	3308180113303	195			Brochable gencodé
1133100	3308180113310	195			Brochable gencodé
1133200	3308180113327	195			Brochable gencodé

PERCEMENTS

Bec de cane	Clé L	Cylindre ou clé I	Condamnation (G ou D)	Décondamnation



Demi-ensemble sur plaque entrée inox

Code	Gencod	Entraxe	Type packaging
1127500	3308180112757	INOX NICKELÉ S. 195	Brochable gencodé 1



Ensemble sur plaque PHOENIX

Code	Gencod	Entraxe	Ressort de rappel	Type de perçement	Type packaging
1128100	3308180112818	INOX BR. 195	-		Brochable gencodé 1
1128200	3308180112825	INOX BR. 195			Brochable gencodé 1
1128300	3308180112832	INOX BR. 195			Brochable gencodé 1
1128400	3308180112849	INOX BR. 195			Brochable gencodé 1

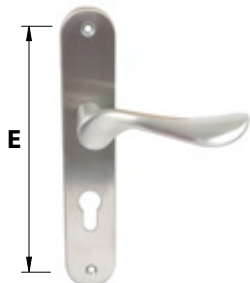

Ensemble sur plaque AUSTIN

Code	Gencod	Entraxe	Ressort de rappel	Type de perçement	Type packaging
1128900	3308180112894	NICKELÉ S. 195	-		Brochable gencodé 1
1129000	3308180112900	NICKELÉ S. 195			Brochable gencodé 1
1129100	3308180112917	NICKELÉ S. 195			Brochable gencodé 1
1129200	3308180112924	NICKELÉ S. 195			Brochable gencodé 1

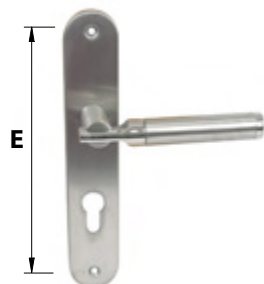

Ensemble sur plaque CHARLOTTE

Code	Gencod	Entraxe	Ressort de rappel	Type de perçement	Type packaging
1129700	3308180112979	NICKELÉ S. 195	-		Brochable gencodé 1
1129800	3308180112986	NICKELÉ S. 195			Brochable gencodé 1
1129900	3308180112993	NICKELÉ S. 195			Brochable gencodé 1
1130000	3308180113006	NICKELÉ S. 195			Brochable gencodé 1

PERCEMENTS

Bec de cane	Clé L	Cylindre ou clé I	Condannation (G ou D)	Décondannation

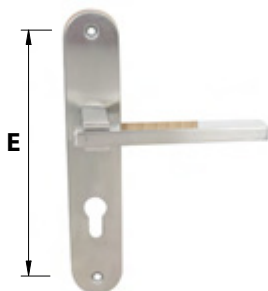

Ensemble sur plaque ATLANTA

Code	Gencod	Entraxe	Ressort de rappel	Type de perçement	Type packaging	
1130100	3308180113013	NICKELÉ S. 195	-		Brochable gencodé	1
1130600	3308180113068	NICKELÉ S. 195			Brochable gencodé	1
1130700	3308180113075	NICKELÉ S. 195			Brochable gencodé	1
1130800	3308180113082	NICKELÉ S. 195			Brochable gencodé	1

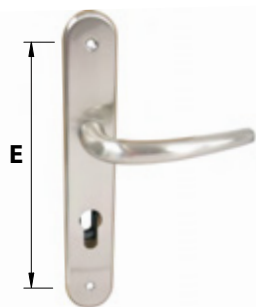

Ensemble sur plaque OAKLAND

Code	Gencod	Entraxe	Ressort de rappel	Type de perçement	Type packaging	
1131300	3308180113136	NICKELÉ S. 195	-		Brochable gencodé	1
1131400	3308180113143	NICKELÉ S. 195			Brochable gencodé	1
1131500	3308180113150	NICKELÉ S. 195			Brochable gencodé	1
1131600	3308180113167	NICKELÉ S. 195			Brochable gencodé	1

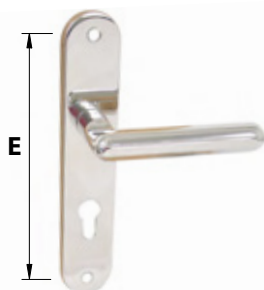

Ensemble sur plaque HOUSTON

Code	Gencod	Entraxe	Ressort de rappel	Type de perçement	Type packaging	
1132500	3308180113259	NICKELÉ BR. 195	-		Brochable gencodé	1
1132600	3308180113266	NICKELÉ BR. 195			Brochable gencodé	1
1132700	3308180113273	NICKELÉ BR. 195			Brochable gencodé	1
1132800	3308180113280	NICKELÉ BR. 195			Brochable gencodé	1

PERCEMENTS

Bec de cane	Clé L	Cylindre ou clé I	Condamnation (G ou D)	Décondamnation



Ensemble sur plaque FLORIDA

Code	Gencod	Entraxe	Ressort de rappel	Type de percement	Type packaging	
1132100	3308180113211	NICKELÉ BR. 195	-		Brochable gencodé	1
1132200	3308180113228	NICKELÉ BR. 195			Brochable gencodé	1
1132300	3308180113235	NICKELÉ BR. 195			Brochable gencodé	1
1132400	3308180113242	NICKELÉ BR. 195			Brochable gencodé	1

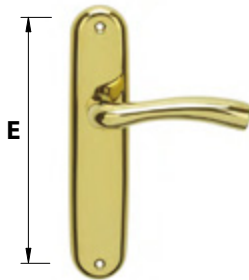

Ensemble sur plaque OBLONGUE ONDINE

Code	Gencod	Entraxe	Ressort de rappel	Type de percement	Type packaging	
1133300	3308180113334	LAITON 195	-		Brochable gencodé	1
1133400	3308180113341	LAITON 195			Brochable gencodé	1
1133500	3308180113358	LAITON 195			Brochable gencodé	1
1133600	3308180113365	LAITON 195			Brochable gencodé	1



Ensemble sur plaque MISSISSIPPI

Code	Gencod	Entraxe	Ressort de rappel	Type de percement	Type packaging	
1133700	3308180113372	LAITON 195	-		Brochable gencodé	1
1133800	3308180113389	LAITON 195			Brochable gencodé	1
1133900	3308180113396	LAITON 195			Brochable gencodé	1
1134000	3308180113402	LAITON 195			Brochable gencodé	1

PERCEMENTS





Bec de cane	Clé L	Cylindre ou clé I	Condamnation (G ou D)	Décondamnation



Ensemble sur rosace ronde CLUB



Code	Gencod		Ressort de rappel	Type packaging	
1134200	3308180113426	NICKELÉ S.		Brochable gencodé	1

2 rosaces de fonction rondes CLUB

Code	Gencod		Type de percement	Type packaging	
1134300	3308180113433	NICKELÉ S.		Brochable gencodé	1
1134400	3308180113440	NICKELÉ S.		Brochable gencodé	1
1134500	3308180113457	NICKELÉ S.		Brochable gencodé	1





Ensemble sur rosace ronde CHARLOTTE

Code	Gencod		Type packaging	
1134600	3308180113464	NICKELÉ S.	Brochable gencodé	1







Ensemble sur rosace ronde LONG BEACH

Code	Gencod		Type packaging	
1134700	3308180113471	NICKELÉ S.	Brochable gencodé	1



2 rosaces de fonction rondes

Code	Gencod		Type de percement	Type packaging	
1135000	3308180113501	NICKELÉ S.		Brochable gencodé	1
1135100	3308180113518	NICKELÉ S.		Brochable gencodé	1
1135200	3308180113525	NICKELÉ S.		Brochable gencodé	1



PERCEMENTS

				
Bec de cane	Clé L	Cylindre ou clé I	Condamnation (G ou D)	Décondamnation



Ensemble sur rosace ronde OAKLAND

Code	Gencod		Ressort de rappel	Type packaging	
1135300	3308180113532	NICKELÉ S.		Brochable gencodé	1

2 rosaces de fonction rondes

Code	Gencod		Type de perçement	Type packaging	
1135400	3308180113549	NICKELÉ S.		Brochable gencodé	1
1135500	3308180113556	NICKELÉ S.		Brochable gencodé	1
1135600	3308180113563	NICKELÉ S.		Brochable gencodé	1



Ensemble sur rosace carrée KANSAS

Code	Gencod		Ressort de rappel	Type packaging	
1135700	3308180113570	NICKELÉ S.		Brochable gencodé	1



Ensemble sur rosace carrée ATLANTA

Code	Gencod		Ressort de rappel	Type packaging	
1135800	3308180113587	NICKELÉ S.		Brochable gencodé	1



2 rosaces de fonction carrées

Code	Gencod		Type de perçement	Type packaging	
1135900	3308180113594	NICKELÉ S.		Brochable gencodé	1
1136000	3308180113600	NICKELÉ S.		Brochable gencodé	1
1136100	3308180113617	NICKELÉ S.		Brochable gencodé	1



PERCEMENTS

Bec de cane	Clé L	Cylindre ou clé I	Condamnation (G ou D)	Décondamnation

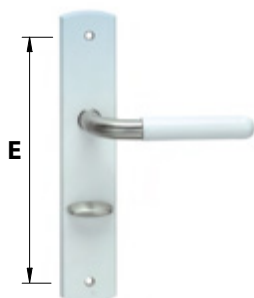

Ensemble sur plaque carrée BROCELIANDE

Code	Gencod	Entraxe	Ressort de rappel	Type de perçement	Type packaging	
1136200	3308180113624	LAQUÉ	195	-		Brochable gencodé 1
1136300	3308180113631	LAQUÉ	195	-		Brochable gencodé 1
1136400	3308180113648	LAQUÉ	195	-		Brochable gencodé 1
1136500	3308180113655	LAQUÉ	195	-		Brochable gencodé 1

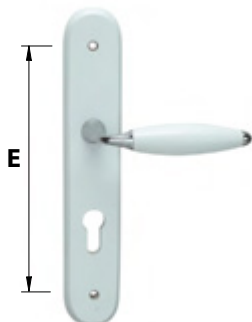

Ensemble sur plaque ronde SHERWOOD

Code	Gencod	Entraxe	Ressort de rappel	Type de perçement	Type packaging	
1136600	3308180113662	LAQUÉ	195	-		Brochable gencodé 1
1136700	3308180113679	LAQUÉ	195	-		Brochable gencodé 1
1136800	3308180113686	LAQUÉ	195	-		Brochable gencodé 1
1136900	3308180113693	LAQUÉ	195	-		Brochable gencodé 1



Ensemble sur rosace ronde SHERWOOD

Code	Gencod	Ressort de rappel	Type packaging	
1137000	3308180113709	LAQUÉ	-	Brochable gencodé 1

2 rosaces de fonction



Code	Gencod	Type de perçement	Type packaging	
1137100	3308180113716	LAQUÉ	Brochable gencodé	1
1137200	3308180113723	LAQUÉ	Brochable gencodé	1
1137300	3308180113730	LAQUÉ	Brochable gencodé	1

PERCEMENTS

Bec de cane	Clé L	Cylindre ou clé I	Condamnation (G ou D)	Décondamnation

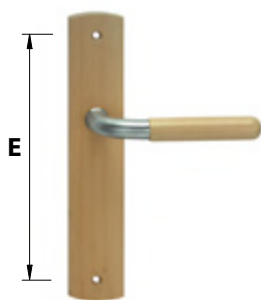

Ensemble sur plaque carrée BROCELIANDE

Code	Gencod		Entraxe	Ressort de rappel	Type de perçement	Type packaging	
1137400	3308180113747	BOIS	195	-		Brochable gencodé	1
1137500	3308180113754	BOIS	195	-		Brochable gencodé	1
1137600	3308180113761	BOIS	195	-		Brochable gencodé	1
1137700	3308180113778	BOIS	195	-		Brochable gencodé	1

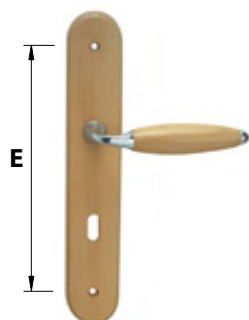

Ensemble sur plaque ronde SHERWOOD

Code	Gencod		Entraxe	Ressort de rappel	Type de perçement	Type packaging	
1137800	3308180113785	BOIS	195	-		Brochable gencodé	1
1137900	3308180113792	BOIS	195	-		Brochable gencodé	1
1138000	3308180113808	BOIS	195	-		Brochable gencodé	1
1138100	3308180113815	BOIS	195	-		Brochable gencodé	1



Ensemble sur rosace ronde BROCELIANDE

Code	Gencod		Type packaging	
1138200	3308180113822	BOIS	Brochable gencodé	1



Ensemble sur rosace ronde SHERWOOD

Code	Gencod		Type packaging	
1138300	3308180113839	BOIS	Brochable gencodé	1



2 rosaces de fonction rondes

Code	Gencod		Type de perçement	Type packaging	
1138400	3308180113846	BOIS		Brochable gencodé	1
1138500	3308180113853	BOIS		Brochable gencodé	1
1138600	3308180113860	BOIS		Brochable gencodé	1

PERCEMENTS

Bec de cane	Clé L	Cylindre ou clé I	Condannation (G ou D)	Décondannation

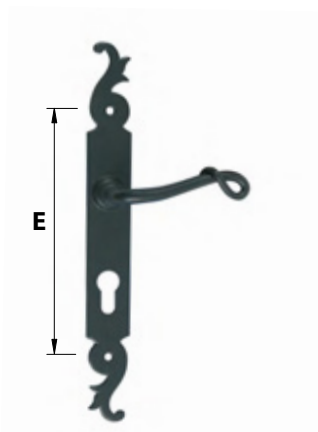

Ensemble sur plaque UPPER

Code	Gencod	Entraxe	Ressort de rappel	Type de perçement	Type packaging
1154700	3308180115475	195	-		Brochable gencodé 1
1154800	3308180115482	195	-		Brochable gencodé 1
1154900	3308180115499	195	-		Brochable gencodé 1
1155000	3308180115505	195	-		Brochable gencodé 1

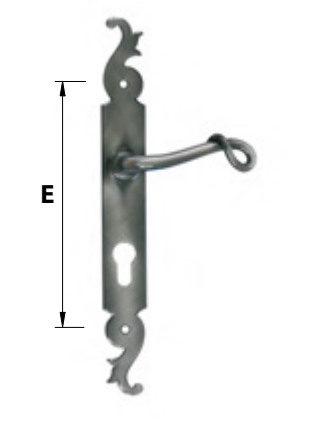

Ensemble sur plaque UPPER

Code	Gencod	Entraxe	Ressort de rappel	Type de perçement	Type packaging
1155100	3308180115512	195	-		ARGENT CEMENTÉ Brochable gencodé 1
1155200	3308180115529	195	-		ARGENT CEMENTÉ Brochable gencodé 1
1155300	3308180115536	195	-		ARGENT CEMENTÉ Brochable gencodé 1
1155400	3308180115543	195	-		ARGENT CEMENTÉ Brochable gencodé 1

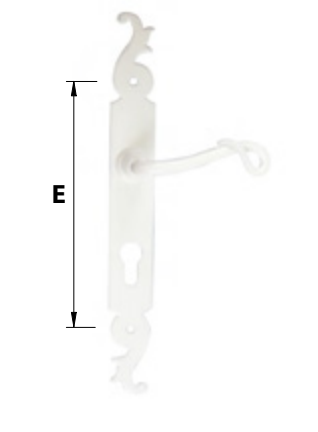

Ensemble sur plaque UPPER

Code	Gencod	Entraxe	Ressort de rappel	Type de perçement	Type packaging
1155500	3308180115550	195	-		LAQUÉ Brochable gencodé 1
1155600	3308180115567	195	-		LAQUÉ Brochable gencodé 1
1155700	3308180115574	195	-		LAQUÉ Brochable gencodé 1
1155800	3308180115581	195	-		LAQUÉ Brochable gencodé 1

PERCEMENTS

Bec de cane	Clé L	Cylindre ou clé I	Condamnation (G ou D)	Décondamnation

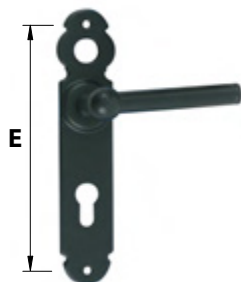

Ensemble sur plaque BILBOQUET

Code	Gencod	Entraxe	Ressort de rappel	Type de perçement	Type packaging	
1155900	3308180115598	195	-		Brochable gencodé	1
1156000	3308180115604	195	-		Brochable gencodé	1
1156100	3308180115611	195	-		Brochable gencodé	1
1156200	3308180115628	195	-		Brochable gencodé	1

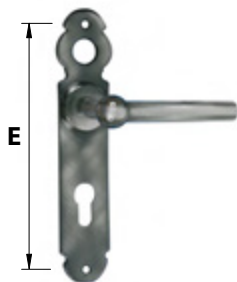

Ensemble sur plaque BILBOQUET

Code	Gencod	Entraxe	Ressort de rappel	Type de perçement	Type packaging	
1156300	3308180115635	195	-		Brochable gencodé	1
1156400	3308180115642	195	-		Brochable gencodé	1
1156500	3308180115659	195	-		Brochable gencodé	1
1156600	3308180115666	195	-		Brochable gencodé	1

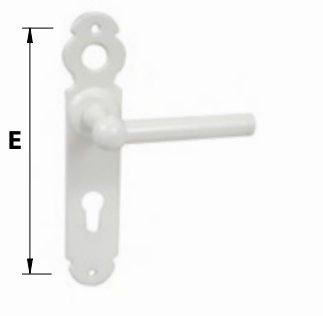

Ensemble sur plaque BILBOQUET

Code	Gencod	Entraxe	Ressort de rappel	Type de perçement	Type packaging	
1156700	3308180115673	195	-		Brochable gencodé	1
1156800	3308180115680	195	-		Brochable gencodé	1
1156900	3308180115697	195	-		Brochable gencodé	1
1157000	3308180115703	195	-		Brochable gencodé	1

PERCEMENTS

Bec de cane	Clé L	Cylindre ou clé I	Condamnation (G ou D)	Décondamnation



Ensemble sur plaque AROBASE

Code	Gencod	Entraxe	Ressort de rappel	Type de perçement	Type packaging
1157100	3308180115710	195	-		Brochable gencodé 1
1157200	3308180115727	195	-		Brochable gencodé 1
1157300	3308180115734	195	-		Brochable gencodé 1
1157400	3308180115741	195	-		Brochable gencodé 1

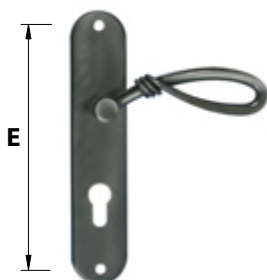

Ensemble sur plaque AROBASE

Code	Gencod	Entraxe	Ressort de rappel	Type de perçement	Type packaging
1157500	3308180115758	195	-		ARGENT CEMENTÉ Brochable gencodé 1
1157600	3308180115765	195	-		ARGENT CEMENTÉ Brochable gencodé 1
1157700	3308180115772	195	-		ARGENT CEMENTÉ Brochable gencodé 1
1157800	3308180115789	195	-		ARGENT CEMENTÉ Brochable gencodé 1

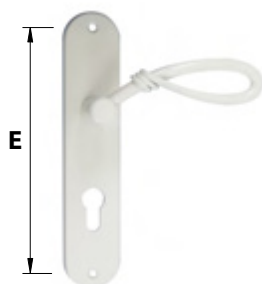

Ensemble sur plaque AROBASE

Code	Gencod	Entraxe	Ressort de rappel	Type de perçement	Type packaging
1157900	3308180115796	195	-		LAQUÉ Brochable gencodé 1
1158000	3308180115802	195	-		LAQUÉ Brochable gencodé 1
1158100	3308180115819	195	-		LAQUÉ Brochable gencodé 1
1158200	3308180115826	195	-		LAQUÉ Brochable gencodé 1

PERCEMENTS

Bec de cane	Clé L	Cylindre ou clé I	Condamnation (G ou D)	Décondamnation

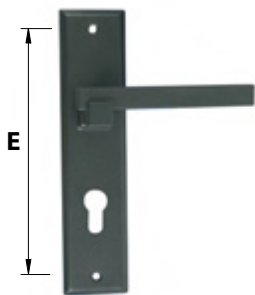

Ensemble sur plaque BROOKLYN

Code	Gencod	Entraxe	Ressort de rappel	Type de perçement	Type packaging	
1158300	3308180115833	195	-		Brochable gencodé	1
1158400	3308180115840	195	-		Brochable gencodé	1
1158500	3308180115857	195	-		Brochable gencodé	1
1158600	3308180115864	195	-		Brochable gencodé	1

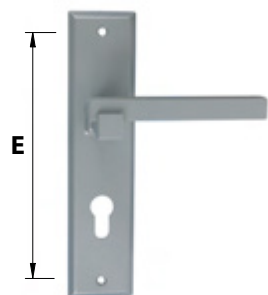

Ensemble sur plaque BROOKLYN

Code	Gencod	Entraxe	Ressort de rappel	Type de perçement	Type packaging	
1158700	3308180115871	SABLE 195	-		Brochable gencodé	1
1158800	3308180115888	SABLE 195	-		Brochable gencodé	1
1158900	3308180115895	SABLE 195	-		Brochable gencodé	1
1159000	3308180115901	SABLE 195	-		Brochable gencodé	1

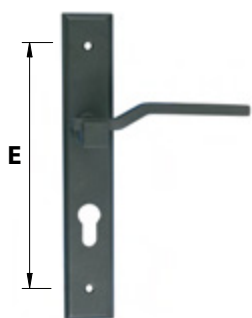

Ensemble sur plaques étroites CENTRAL PARK

Code	Gencod	Entraxe	Ressort de rappel	Type de perçement	Type packaging	
1159100	3308180115918	SABLE 195	-		Brochable gencodé	1
1159200	3308180115925	SABLE 195	-		Brochable gencodé	1
1159300	3308180115932	SABLE 195	-		Brochable gencodé	1
1159400	3308180115949	SABLE 195	-		Brochable gencodé	1

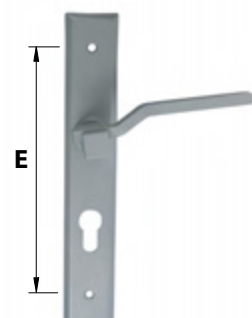

Ensemble sur plaques étroites CENTRAL PARK

Code	Gencod	Entraxe	Ressort de rappel	Type de perçement	Type packaging	
1159500	3308180115956	SABLE 195	-		Brochable gencodé	1
1159600	3308180115963	SABLE 195	-		Brochable gencodé	1
1159700	3308180115970	SABLE 195	-		Brochable gencodé	1
1159800	3308180115987	SABLE 195	-		Brochable gencodé	1

PERCEMENTS

Bec de cane	Clé L	Cylindre ou clé I	Condamnation (G ou D)	Décondamnation



Ensemble sur rosace ronde UPPER

Code	Gencod		Ressort de rappel	Type packaging	
1159900	3308180115994	MAT	-	Brochable gencodé	1



Ensemble sur rosace ronde BILBOQUET

Code	Gencod		Ressort de rappel	Type packaging	
1160000	3308180116007	MAT	-	Brochable gencodé	1



Ensemble sur rosace ronde AROBASE

Code	Gencod		Ressort de rappel	Type packaging	
1160100	3308180116014	MAT	-	Brochable gencodé	1

2 rosaces de fonction rondes



Code	Gencod		Type de perçement	Type packaging	
1160200	3308180116021	MAT		Brochable gencodé	1
1160300	3308180116038	MAT		Brochable gencodé	1
1160400	3308180116045	MAT		Brochable gencodé	1
1160500	3308180116052	MAT		Brochable gencodé	1

PERCEMENTS

Bec de cane	Clé L	Cylindre ou clé I	Condamnation (G ou D)	Décondamnation



Ensemble sur rosace ronde UPPER

Code	Gencod	 ARGENT CEMENTE	Ressort de rappel	Type packaging	
1160600	3308180116069	ARGENT CEMENTE	-	Brochable gencodé	1



Ensemble sur rosace ronde BILBOQUET

Code	Gencod	 ARGENT CEMENTE	Ressort de rappel	Type packaging	
1160700	3308180116076	ARGENT CEMENTE	-	Brochable gencodé	1









Ensemble sur rosace ronde AROBASE

Code	Gencod	 ARGENT CEMENTE	Ressort de rappel	Type packaging	
1160800	3308180116083	ARGENT CEMENTE	-	Brochable gencodé	1



2 rosaces de fonction rondes

Code	Gencod	 ARGENT CEMENTE	Type de percement	Type packaging	
1160900	3308180116090	ARGENT CEMENTE		Brochable gencodé	1
1161000	3308180116106	ARGENT CEMENTE		Brochable gencodé	1
1161100	3308180116113	ARGENT CEMENTE		Brochable gencodé	1
1161200	3308180116120	ARGENT CEMENTE		Brochable gencodé	1

PERCEMENTS

				
Bec de cane	Clé L	Cylindre ou clé I	Condammation (G ou D)	Décondammation

Ensemble sur rosace ronde UPPER



Code	Gencod	LAQUÉ	Ressort de rappel	Type packaging	
1161300	3308180116137	LAQUÉ	-	Brochable gencodé	1

Ensemble sur rosace ronde BILBOQUET



Code	Gencod	LAQUÉ	Ressort de rappel	Type packaging	
1161400	3308180116144	LAQUÉ	-	Brochable gencodé	1

Ensemble sur rosace ronde AROBASE



Code	Gencod	LAQUÉ	Ressort de rappel	Type packaging	
1161500	3308180116151	LAQUÉ	-	Brochable gencodé	1

2 rosaces de fonction rondes



Code	Gencod	LAQUÉ	Type de perçement	Type packaging	
1161600	3308180116168	LAQUÉ		Brochable gencodé	1
1161700	3308180116175	LAQUÉ		Brochable gencodé	1
1161800	3308180116182	LAQUÉ		Brochable gencodé	1
1161900	3308180116199	LAQUÉ		Brochable gencodé	1

PERCEMENTS

Bec de cane	Clé L	Cylindre ou clé I	Condamnation (G ou D)	Décondamnation



Ensemble sur rosace carrée BROOKLYN

Code	Gencod	SABLE	Ressort de rappel	Type packaging	
1162000	3308180116205	SABLE	-	Brochable gencodé	1



Ensemble sur rosace carrée CENTRAL PARK

Code	Gencod	SABLE	Ressort de rappel	Type packaging	
1162100	3308180116212	SABLE	-	Brochable gencodé	1

2 rosaces de fonction carrées



Code	Gencod	SABLE	Type de perçement	Type packaging	
1162200	3308180116229	SABLE		Brochable gencodé	1
1162300	3308180116236	SABLE		Brochable gencodé	1
1162400	3308180116243	SABLE		Brochable gencodé	1
1162500	3308180116250	SABLE		Brochable gencodé	1



Ensemble sur rosace carrée BROOKLYN

Code	Gencod	SABLE	Ressort de rappel	Type packaging	
1162600	3308180116267	SABLE	-	Brochable gencodé	1



Ensemble sur rosace carrée CENTRAL PARK

Code	Gencod	SABLE	Ressort de rappel	Type packaging	
1162700	3308180116274	SABLE	-	Brochable gencodé	1



2 rosaces de fonction carrées

Code	Gencod	SABLE	Type de perçement	Type packaging	
1162800	3308180116281	SABLE		Brochable gencodé	1
1162900	3308180116298	SABLE		Brochable gencodé	1
1163000	3308180116304	SABLE		Brochable gencodé	1
1163100	3308180116311	SABLE		Brochable gencodé	1

PERCEMENTS

Bec de cane	Clé L	Cylindre ou clé I	Condamnation (G ou D)	Décondamnation



BOUVET
1884



L'INTÉRIEUR DE L'HABITAT

LA PORTE INTÉRIEURE



Ensemble sur rosace carrée ARTHEMIS

Code	Gencod		L	H	Ressort de rappel	Type packaging	
2000100FB	3152511114268		135	54,5		Brochable gencodé	1

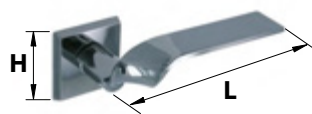

Ensemble sur rosace carrée AQUILIS

Code	Gencod		L	H	Ressort de rappel	Type packaging	
2000200FB	3152511115234		135	54,5		Brochable gencodé	1



Ensemble sur rosace carrée THORSION

Code	Gencod		L	H	Ressort de rappel	Type packaging	
2000300FB	3152511115463		128	54,5		Brochable gencodé	1



Ensemble sur rosace carrée PHILEAS

Code	Gencod		L	H	Ressort de rappel	Type packaging	
2000500FB	3152511115715		130	54,5		Brochable gencodé	1

2 rosaces de fonction carrées

Code	Gencod		H	Type de perçement	Type packaging	
55021100FB	3152511114633		54,5		Brochable gencodé	1
66021100FB	3152511114510		54,5		Brochable gencodé	1
11021100FB	3152511114893		54,5		Brochable gencodé	1





PERCEMENTS

Bec de cane	Clé L	Cylindre ou clé I	Condamnation (G ou D)	Décondamnation





Ensemble sur rosace carrée ARTHEMIS

Code	Gencod		L	H	Ressort de rappel	Type packaging	
2000100CB	3152511114169	CHROME BRILLANT	135	54,5		Brochable gencodé	1





Ensemble sur rosace carrée AQUILIS

Code	Gencod		L	H	Ressort de rappel	Type packaging	
2000200CB	3152511115296	CHROME BRILLANT	135	54,5		Brochable gencodé	1





Ensemble sur rosace carrée THORSION

Code	Gencod		L	H	Ressort de rappel	Type packaging	
2000300CB	3152511115579	CHROME BRILLANT	128	54,5		Brochable gencodé	1







Ensemble sur rosace carrée PHILEAS

Code	Gencod		L	H	Ressort de rappel	Type packaging	
2000500CB	3152511115777	CHROME BRILLANT	130	54,5		Brochable gencodé	1

2 rosaces de fonction carrées



Code	Gencod		H	Type de perçement	Type packaging	
55021100CB	3152511114800	CHROME BRILLANT	54,5		Brochable gencodé	1
66021100CB	3152511114558	CHROME BRILLANT	54,5		Brochable gencodé	1
11021100CB	3152511114954	CHROME BRILLANT	54,5		Brochable gencodé	1

PERCEMENTS

				
Bec de cane	Clé L	Cylindre ou clé I	Condamnation (G ou D)	Décondamnation



Ensemble sur rosace carrée ARTHEMIS

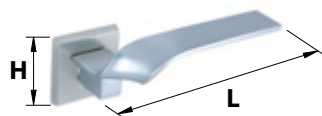

Code	Gencod		L	H	Ressort de rappel	Type packaging	
2000100CS	3152511114206	CHROME SATINE	135	54,5		Brochable gencodé	1

Ensemble sur rosace carrée AQUILIS



Code	Gencod		L	H	Ressort de rappel	Type packaging	
2000200CS	3152511115326	CHROME SATINE	135	54,5		Brochable gencodé	1

Ensemble sur rosace carrée THORSION

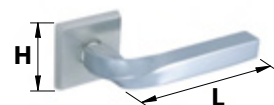

Code	Gencod		L	H	Ressort de rappel	Type packaging	
2000300CS	3152511115609	CHROME SATINE	128	54,5		Brochable gencodé	1

Ensemble sur rosace carrée PHILEAS



Code	Gencod		L	H	Ressort de rappel	Type packaging	
2000500CS	3152511115807	CHROME SATINE	130	54,5		Brochable gencodé	1

2 rosaces de fonction carrées





Code	Gencod		H	Type de perçement	Type packaging	
55021100CS	3152511114824	CHROME SATINE	54,5		Brochable gencodé	1
66021100CS	3152511114572	CHROME SATINE	54,5		Brochable gencodé	1
11021100CS	3152511115005	CHROME SATINE	54,5		Brochable gencodé	1

PERCEMENTS

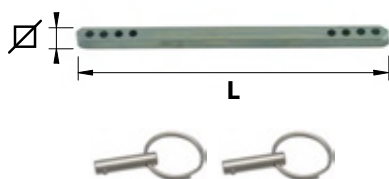
Bec de cane	Clé L	Cylindre ou clé I	Condamnation (G ou D)	Décondamnation



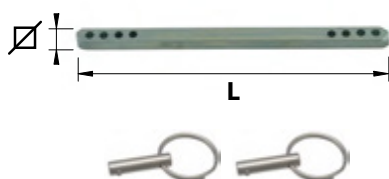

Carré à trous & 2 goupilles

Code	Gencod		∅	L	Type packaging	
1163200	3308180116328	BRUT	7	80	Brochable gencodé	1
1163300	3308180116335	BRUT	7	90	Brochable gencodé	1
1163400	3308180116342	BRUT	7	110	Brochable gencodé	1
1163500	3308180116359	BRUT	7	115	Brochable gencodé	1
1163600	3308180116366	BRUT	7	120	Brochable gencodé	1





Carré à trous & 2 goupilles

Code	Gencod		∅	L	Type packaging	
1163700	3308180116373	BRUT	8	80	Brochable gencodé	1
1163800	3308180116380	BRUT	8	90	Brochable gencodé	1
1163900	3308180116397	BRUT	8	110	Brochable gencodé	1
1164000	3308180116403	BRUT	8	115	Brochable gencodé	1
1164100	3308180116410	BRUT	8	120	Brochable gencodé	1



Carré fendu à gorge

Code	Gencod		∅	L	Type packaging	
1164200	3308180116427	BRUT	7	80	Brochable gencodé	1
1164300	3308180116434	BRUT	7	90	Brochable gencodé	1
1164400	3308180116441	BRUT	7	110	Brochable gencodé	1
1164500	3308180116458	BRUT	7	115	Brochable gencodé	1
1164600	3308180116465	BRUT	7	120	Brochable gencodé	1



Carré fendu à gorge

Code	Gencod			L	Type packaging	
1164700	3308180116472	BRUT	8	80	Brochable gencodé	1
1164800	3308180116489	BRUT	8	90	Brochable gencodé	1
1164900	3308180116496	BRUT	8	110	Brochable gencodé	1
1165000	3308180116502	BRUT	8	115	Brochable gencodé	1
1165100	3308180116519	BRUT	8	120	Brochable gencodé	1

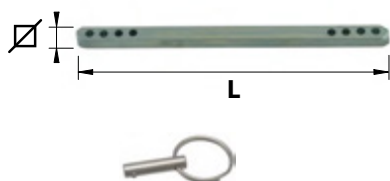

Carré à trous & 1 goupille

Code	Gencod			L	Type packaging	
1165200	3308180116526	BRUT	7	80	Brochable gencodé	1
1165300	3308180116533	BRUT	7	90	Brochable gencodé	1
1165400	3308180116540	BRUT	7	110	Brochable gencodé	1
1165500	3308180116557	BRUT	7	115	Brochable gencodé	1
1165600	3308180116564	BRUT	7	120	Brochable gencodé	1

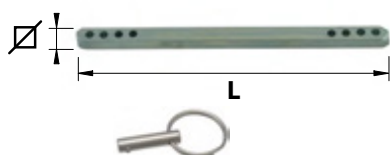

Carré à trous & 1 goupille

Code	Gencod			L	Type packaging	
1165700	3308180116571	BRUT	8	80	Brochable gencodé	1
1165800	3308180116588	BRUT	8	90	Brochable gencodé	1
1165900	3308180116595	BRUT	8	110	Brochable gencodé	1
1166000	3308180116601	BRUT	8	115	Brochable gencodé	1
1166100	3308180116618	BRUT	8	120	Brochable gencodé	1

Carré percé des 2 bouts



Code	Gencod			L	Type packaging	
1166200	3308180116625	BRUT	7	80	Brochable gencodé	1
1166300	3308180116632	BRUT	7	90	Brochable gencodé	1
1166400	3308180116649	BRUT	7	110	Brochable gencodé	1
1166500	3308180116656	BRUT	7	115	Brochable gencodé	1
1166600	3308180116663	BRUT	7	120	Brochable gencodé	1

Carré percé des 2 bouts



Code	Gencod			L	Type packaging	
1166700	3308180116670	BRUT	8	80	Brochable gencodé	1
1166800	3308180116687	BRUT	8	90	Brochable gencodé	1
1166900	3308180116694	BRUT	8	110	Brochable gencodé	1
1167000	3308180116700	BRUT	8	115	Brochable gencodé	1
1167100	3308180116717	BRUT	8	120	Brochable gencodé	1

Carré lisse



Code	Gencod			L	Type packaging	
1167200	3308180116724	BRUT	7	80	Brochable gencodé	1
1167300	3308180116731	BRUT	7	90	Brochable gencodé	1
1167400	3308180116748	BRUT	7	110	Brochable gencodé	1
1167500	3308180116755	BRUT	7	115	Brochable gencodé	1
1167600	3308180116762	BRUT	7	120	Brochable gencodé	1

Carré lisse



Code	Gencod			L	Type packaging	
1167700	3308180116779	BRUT	8	80	Brochable gencodé	1
1167800	3308180116786	BRUT	8	90	Brochable gencodé	1
1167900	3308180116793	BRUT	8	110	Brochable gencodé	1
1168000	3308180116809	BRUT	8	115	Brochable gencodé	1
1168100	3308180116816	BRUT	8	120	Brochable gencodé	1

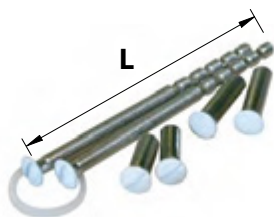

**2 tiges relieuses sectionnables & 4 douilles fendues
+ 2 douilles aveugles**

Code	Gencod		L	Type packaging	
1168200	3308180116823	NICHELÉ S.	80	Brochable gencodé	1
1168300	3308180116830		90	Brochable gencodé	1
1168400	3308180116847	MAT	110	Brochable gencodé	1
1168500	3308180116854	LAITON POLI	115	Brochable gencodé	1
1168600	3308180116861	LAITON VIEILLI	120	Brochable gencodé	1

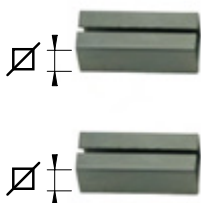

2 fourreaux de passage

Code	Gencod			Type packaging	
1168700	3308180116878	BRUT	6 à 7	Brochable gencodé	1
1168800	3308180116885	BRUT	7 à 8	Brochable gencodé	1



2 portées pour carré diamètre 8 mm

Code	Gencod		Type packaging	
1168900	3308180116892	BRUT	Brochable gencodé	1



Goupille pour carré à trou (x2)

Code	Gencod		Type packaging	
1169000	3308180116908	BRUT	Brochable gencodé	1



**Circlips
2 x Ø 11 + 2 x Ø 13 + 2 x Ø 14 + 2 x Ø 16mm (x8)**

Code	Gencod		Type packaging	
1169100	3308180116915	BRUT	Brochable gencodé	1 sachet 8 pièces



L'INTÉRIEUR DE L'HABITAT

LA FENÊTRE

Crémones décoratives

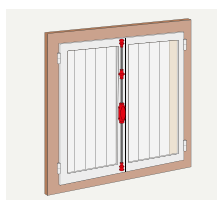
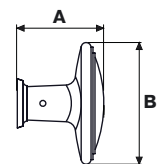

Crémone décorative + Bouton

Code	Gencod		A	B	Type packaging	
Pour tringle 16x5 mm						
041345	3221680413455	EPOXY	44	66	Brochable gencodé	1

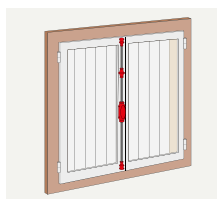

Crémone décorative + Bouton

Code	Gencod		A	B	Type packaging	
Pour tringle 16x8 mm						
041146	3221680411468	EPOXY	44	66	Brochable gencodé	1

Crémones fonctionnelles

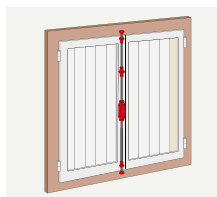

Crémone fonctionnelle + Bouton ovale

Code	Gencod		A	B	Type packaging	
Pour tringle 16x5 mm						
041372	3221680413721		44	66	Brochable gencodé	1
041361	3221680413615	APPRET	44	66	Brochable gencodé	1

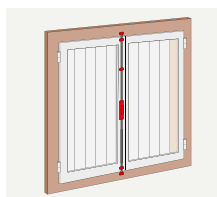

Crémone fonctionnelle + Bouton

Code	Gencod		A	B	Type packaging	
Pour tringle 16x5 mm						
041321	3221680413219	APPRET	21	41	Brochable gencodé	1

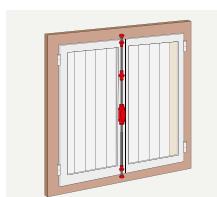

Crémone fonctionnelle + Bouton

Code	Gencod		A	B	Type packaging	
Renforcée - Pour tringle 16x8 mm						
041273	3221680412731		44	65	Brochable gencodé	1

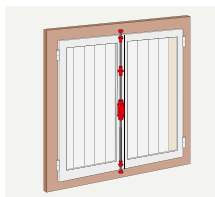
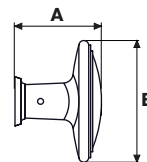

Crémone fonctionnelle + Bouton

Code	Gencod		A	B	Type packaging	
Renforcée - Pour tringle 18x9 mm						
042101	3221680421016	APPRET	50	72	Brochable gencodé	1

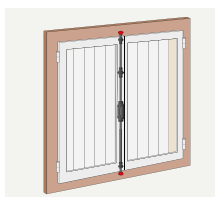

Gâche de crémone

Code	Gencod		L	H	Type packaging	
Pour RY 59/18 - Classique						
053501	3479040535013	APPRET	43	36	Vrac gencodé	6

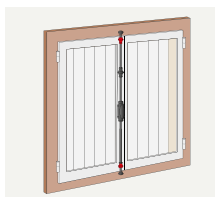

Chapiteau de crémone

Code	Gencod		L	H	Type packaging	
Pour RY 59/18 - Classique						
055501	3479040555011	APPRET	43	69	Vrac gencodé	6

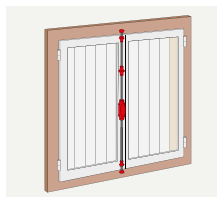

Crémone fonctionnelle + Bouton

Code	Gencod		A	B	Type packaging	
Renforcée - Pour tringle 16x8 mm						
041161	3221680411611	APPRET	44	65	Brochable gencodé	1

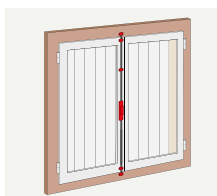

Crémone fonctionnelle + Bouton

Code	Gencod		A	B	Type packaging	
Pour tringle 16x8 mm						
041119	3221680411192	APPRET	37	85	Brochable gencodé	1

Tringles

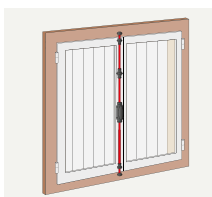

Tringle pour crémonne 16x5 mm

Code	Gencod		Ø	L	Ep	Type packaging	
062170	3479040621709		16	1600	5	Vrac gencodé	6
062190	3479040621907		16	2500	5	Vrac gencodé	6
062210	3479040622102	Z.BLANC	16	1600	5	Vrac gencodé	6
062215	3479040622157	Z.BLANC	16	2000	5	Vrac gencodé	6
062220	3479040622201	Z.BLANC	16	2500	5	Vrac gencodé	6

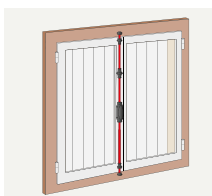

Tringle pour crémonne 16x8 mm

Code	Gencod		Ø	L	Ep	Type packaging	
062550	3479040625509		16	1600	8	Vrac gencodé	6
062560	3479040625608		16	2000	8	Vrac gencodé	6
062570	3479040625707		16	2500	8	Vrac gencodé	6
062520	3479040625202	Z.BLANC	16	2500	8	Vrac gencodé	6

Loqueteaux

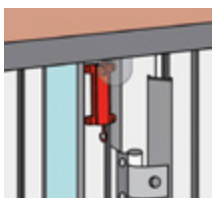
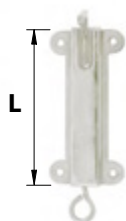

Loqueteau de fenêtre

Code	Gencod		L	Type packaging	
512023	3479045120238	Z.BLANC	100	Vrac gencodé	10

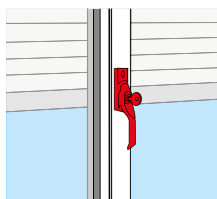

Poignée de crémonne à clé N°1

Code	Gencod		A	B	Type packaging	
0994000	3308189940009	<input type="text"/>	60	80	Brochable gencodé	1

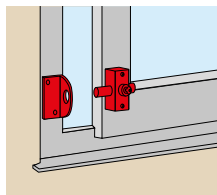

Verrou de fenêtre universelle

Code	Gencod		L	H	Type packaging	
0410726	3308184107261	<input type="text"/>	90	40	Brochable gencodé	1

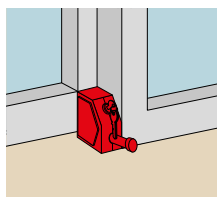

Verrou de baie coulissante à clé

Code	Gencod		Type packaging	
600910	3221686009102	<input type="text"/>	Brochable gencodé	1
0218100	3308182181003	<input type="text"/>	Brochable gencodé	1

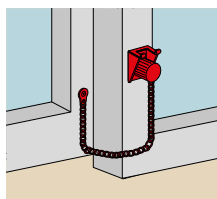
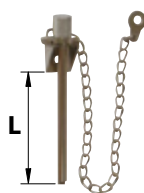

Goupille de sécurité

Code	Gencod		D	L	Type packaging	
0237400	3308182374009	Z.BLANC	4,7	80	Brochable gencodé	1

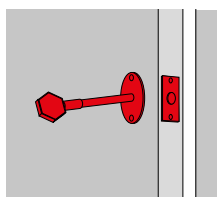
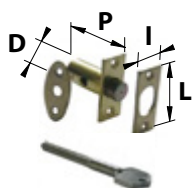

Verrou à clé à larder court

Code	Gencod		D	L	I	P	Type packaging	
0411300	3308184113002	LAITON	16	42	20	36	Brochable gencodé	1



**INSTALLATION
RAPIDE**



**VIDÉOS
D'INSTALLATION**



**KITS
RECOUPABLES**



**PRÉSENTATION
DES GAMMES**

L'INTÉRIEUR DE L'HABITAT

MOUSTIQUAIRES COSI

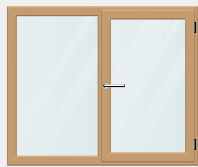

FENÊTRES

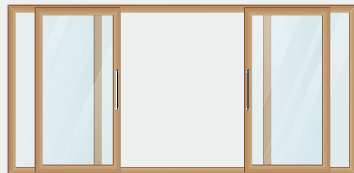

**PORTE-FENÊTRES
PORTES
BAIES VITRÉES**



VOLETS ROULANTS



P.74

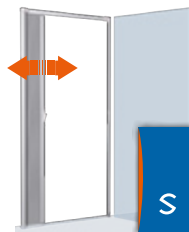

P.74



P.80

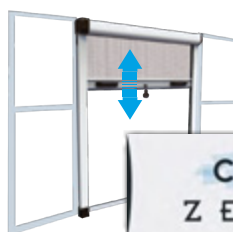

P.76

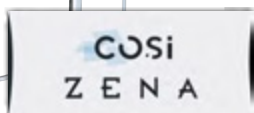

P.76

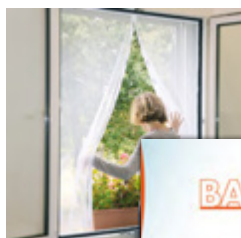

P.83

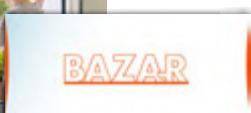

P.83



P.84



P.78



P.82



P.84

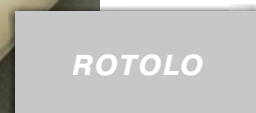



MOUSTIQUAIRES ENROULABLES / RIDEAUX

FENÊTRES - PORTES / BAIES VITRÉES - VOLETS ROULANTS



4 GAMMES

POUR S'ADAPTER À VOS BESOINS !

Pour mieux protéger votre intérieur des moustiques ainsi que d'autres insectes volants ou rampants, nous vous proposons une gamme complète de moustiquaires.

Notre gamme COSI s'adapte à toutes les configurations :

- Moustiquaires enroulables pour fenêtres et portes (Serena, Zena, Moskito)
- Moustiquaires pour portes, portes-fenêtres et baies vitrées (Serena, Zena, Garden)
- Moustiquaires pour volets roulants (UP, Derby)
- Rideaux et rouleaux moustiquaires (Bazar – Rotolo)

Les produits sont livrés à l'unité ou en box.



**INSTALLATION
RAPIDE**



**VIDÉOS
D'INSTALLATION**



**KITS
RECOUPABLES**



**PRÉSENTATION
DES GAMMES**

MOUSTIQUAIRES ENROULABLES

COsi
SERENA

SANS PERÇAGE, NI VIS

STRUCTURE ALUMINIUM BLANC - TOILE EN FIBRE DE VERRE GRISE

- Fixation facile et rapide par **système expansion**.
- Enroulement maîtrisé **grâce au frein**.
- **Pose facile** : tolérance de découpe de 10 à 20 mm.

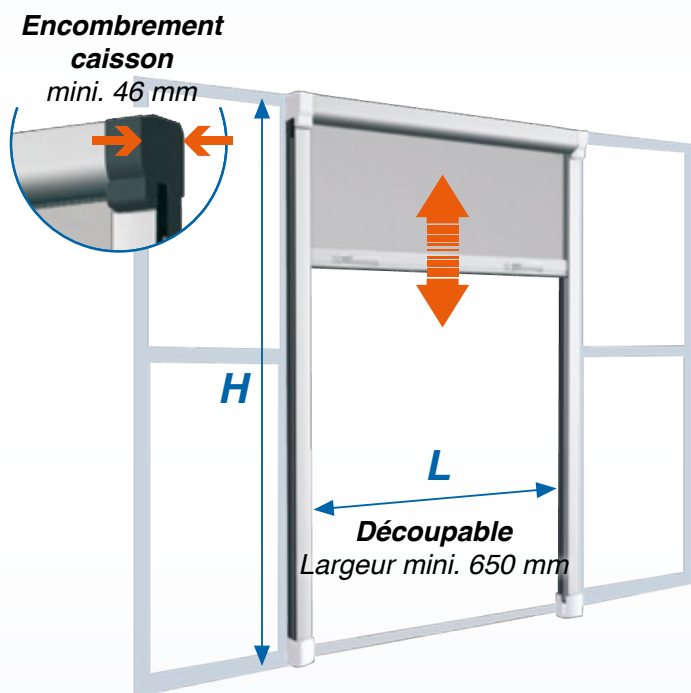

POUR FENÊTRE

L1000 X
H1700 MM

Réf. **401101**
Réf. **401105**

L1400 X
H1700 MM

Réf. **401102**
Réf. **401106**

L1600 X
H1700 MM

Réf. **401103**
Réf. **401107**

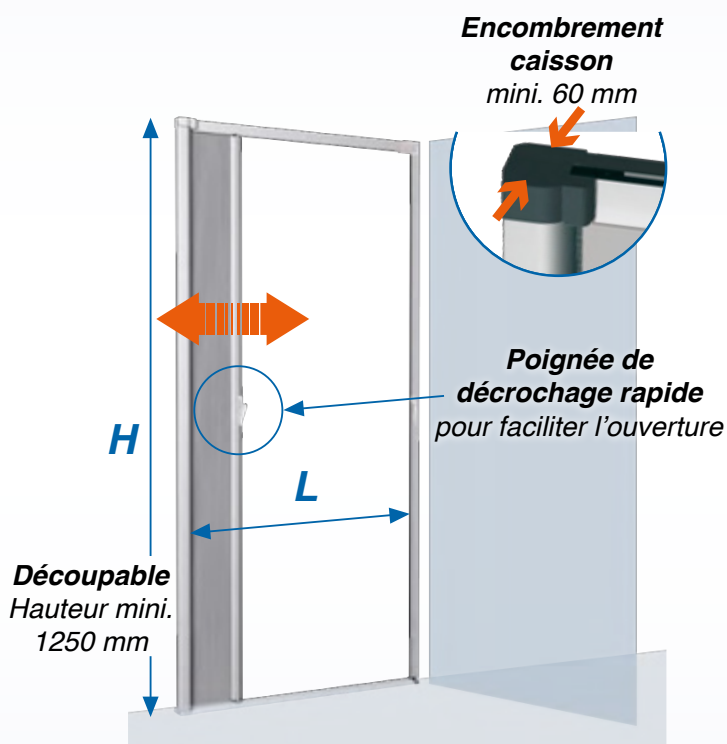

POUR PORTE / PORTE-FENÊTRE

L1600 X
H2500 MM

Réf. **401104**
Réf. **401108**



MOUSTIQUAIRES ENROULABLES SANS PERÇAGE, NI VIS



Moustiquaire COSI Serena - Pour fenêtres

Code	Gencod		L	H	e*	Type packaging	
401101	3308184011018	9010	1000	1700	46		1
401102	3308184011025	9010	1400	1700	46	Vrac gencodé	1
401103	3308184011032	9010	1600	1700	46		1
401105	3517650812732	7016	1000	1700	46		1
401106	3517650812749	7016	1400	1700	46	Vrac gencodé	1
401107	3517650812756	7016	1600	1700	46		1

*e = Epaisseur du caisson

Espace nécessaire entre la fenêtre et le volet pour installer la moustiquaire.



3 KITS RECOURPABLES

3 dimensions sont disponibles pour les fenêtres.
Les kits sont recoupables en largeur (mini. L 650 mm)
et en hauteur pour s'adapter à vos fenêtres.

STRUCTURE ALU - TOILE FIBRE DE VERRE



PALBOX Bois à composer - Moustiquaires COSI Serena

Code	Gencod		Type packaging	
401114			Palbox Bois VIDE	

Minimum d'achat de 1500 € HT net de moustiquaires SERENA.

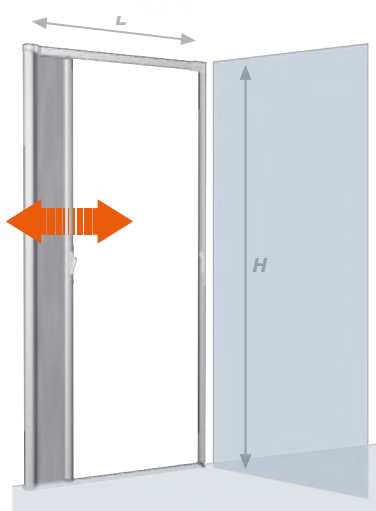

Moustiquaire COSI Serena - Pour porte-fenêtres

Code	Gencod		L	H	e*	Type packaging	
401104	3308184011049	9010	1600	2500	60	Unitaire livrée hors palbox	
401108	3517650812763	7016	1600	2500	60	Vrac gencodé Unitaire livrée hors palbox	

*e = Epaisseur du caisson

Espace nécessaire entre la fenêtre et le volet pour installer la moustiquaire.



L X H RECOURPABLES

Le kit 1600 x 2500 mm est disponible pour les portes.
Il est recoupable en hauteur (mini. H 1250 mm)
et en largeur pour s'adapter à vos ouvertures.

STRUCTURE ALU - TOILE FIBRE DE VERRE



**FERMETURE
VERS LA DROITE,
CAISSON À GAUCHE**

Vue extérieure

**SYSTÈME EXPANSION
AVEC CLÉ ALLEN**

MOUSTIQUAIRES ENROULABLES

COSI
ZEN A

FIXATION SIMPLE

STRUCTURE ALUMINIUM BLANC - TOILE EN FIBRE DE VERRE GRISE

- **Perçage** pour supports de fixation.
- **Clipsage** des profilés aux supports.
- Enroulement maîtrisé **grâce au frein**.
- **Pose facile** : tolérance de découpe jusqu'à 5 mm.

Encombrement
caisson
mini. 45 mm

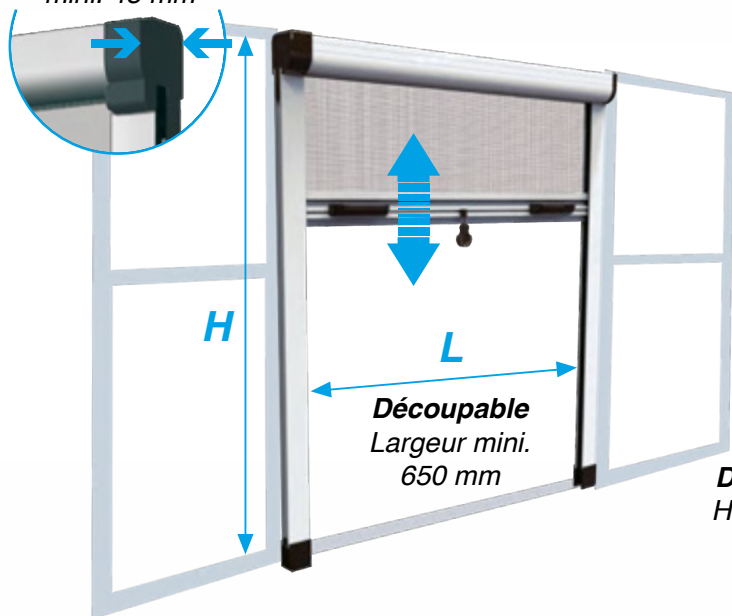

Encombrement
caisson
mini. 45 mm

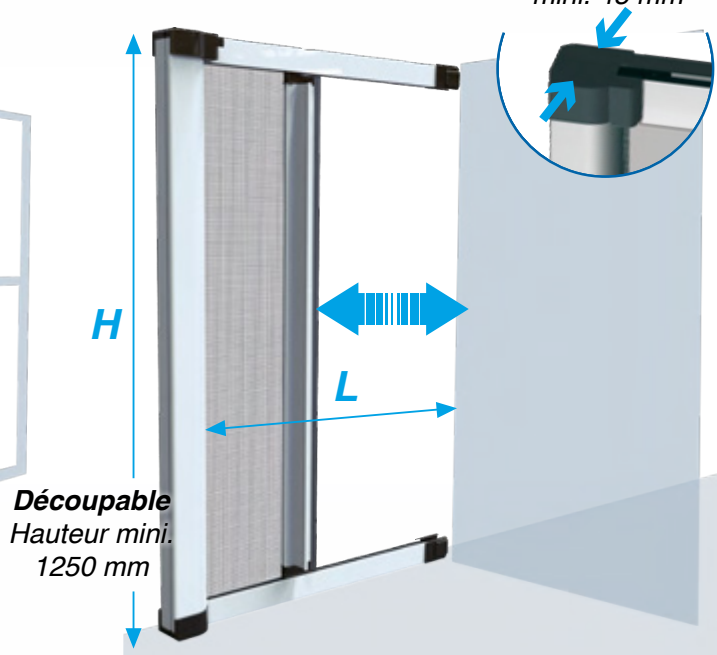

POUR FENÊTRE

L1000 X
H1700 MM

Réf. 402101

L1400 X
H1700 MM

Réf. 402102

L1600 X
H1700 MM

Réf. 402103



POUR PORTE / PORTE-FENÊTRE

L1600 X
H2500 MM

Réf. 402104





MOUSTIQUAIRES ENROULABLES FIXATION SIMPLE

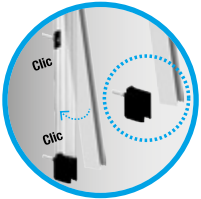
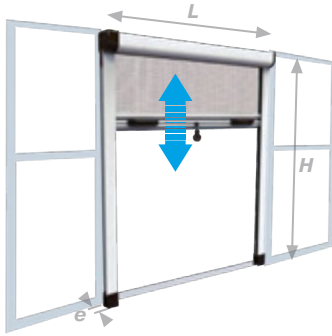

CLIPSAGE DE LA STRUCTURE



Moustiquaire COSI Zena - Pour fenêtres

Code	Gencod		L	H	e*	Type packaging	
402101	3308184021017	9010	1000	1700	45		1
402102	3308184021024	9010	1400	1700	45	Vrac gencodé	1
402103	3308184021031	9010	1600	1700	45		1

*e = Epaisseur du caisson

Espace nécessaire entre la fenêtre et le volet pour installer la moustiquaire.

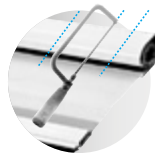

3 KITS RECOURPABLES

3 dimensions sont disponibles pour les fenêtres. Les kits sont recoupables en largeur (mini. L 650 mm) et en hauteur pour s'adapter à vos fenêtres.

STRUCTURE ALU - TOILE FIBRE DE VERRE

PALBOX à composer - Moustiquaires COSI Zena

Code	Gencod	Type packaging	
401129		Palbox carton VIDE	

Minimum d'achat de 1000 € HT net de moustiquaires ZENA.

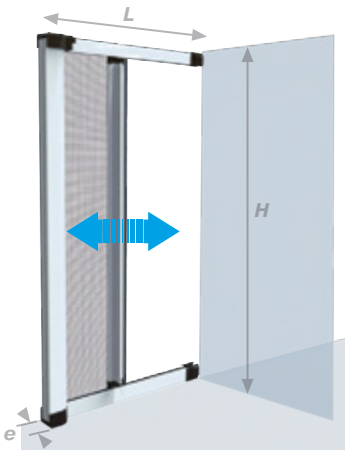

CLIPSAGE DE LA STRUCTURE



Moustiquaire COSI Zena - Pour porte-fenêtres

Code	Gencod		L	H	e*	Type packaging	
402104	3308184021048	9010	1600	2500	45	Vrac gencodé	Unitaire livrée hors palbox

*e = Epaisseur du caisson

Espace nécessaire entre la fenêtre et le volet pour installer la moustiquaire.

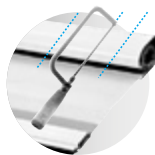

L X H RECOURPABLES

Le kit 1600 x 2500 mm est disponible pour les portes. Il est recoupable en hauteur (mini. H 1250 mm) et en largeur pour s'adapter à vos ouvertures.

STRUCTURE ALU - TOILE FIBRE DE VERRE

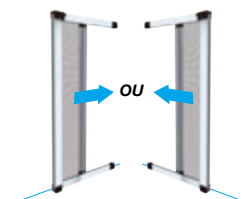

FERMETURE SENS GAUCHE OU SENS DROITE
Vue extérieure

MOUSTIQUAIRES ENROULABLES SANS PERÇAGE, NI VIS

KIT MOUSTIQUAIRE POUR BAIE VITRÉE POUR DOUBLE VANTAUX

Moustiquaire - Pour baies-vitrées

Code	Gencod		L	H	Type packaging	
401115	3517654011155	9010	3200	2500	Vrac gencodé	1

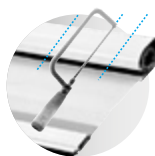

L X H RECOUPABLES

Recoupable en hauteur (mini. H 1250 mm) et en largeur pour s'adapter à toutes vos ouvertures.

STRUCTURE ALU - TOILE FIBRE DE VERRE

DISPONIBLE SUR DEMANDE

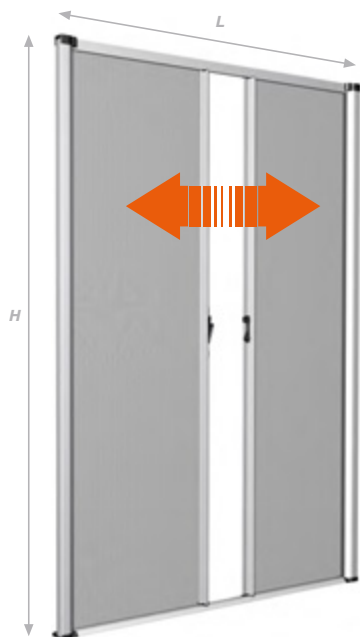

SYSTÈME EXPANSION
FIXATION SANS VISSERIE

BOUTON D'OUVERTURE
RAPIDE

PASSAGE FACILITÉ

GARDEN

MOUSTIQUAIRES PORTES BATTANTES FIXATION SIMPLE

Moustiquaire Garden - Pour porte

Code	Gencod		L	H	Type packaging	
405101	8028250310641	9010	1000	2500	Vrac gencodé	2

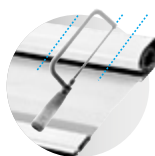

L X H RECOUPABLES

PERÇAGE POUR SUPPORTS DE FIXATION

Fermeture magnétique - Sens d'ouverture libre
Traverse intermédiaire de renfort

STRUCTURE ALU - TOILE FIBRE DE VERRE

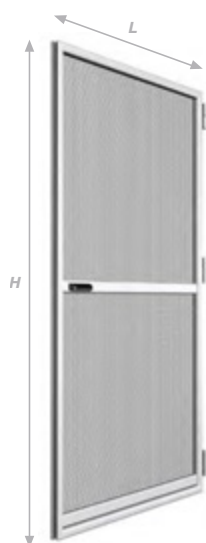



MOUSTIQUAIRES

POUR PORTES, PORTE-FENÊTRES, BAIES VITRÉES

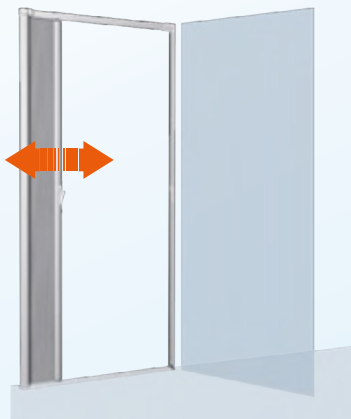

COSI SERENA P.75
POUR PORTE-FENÊTRES

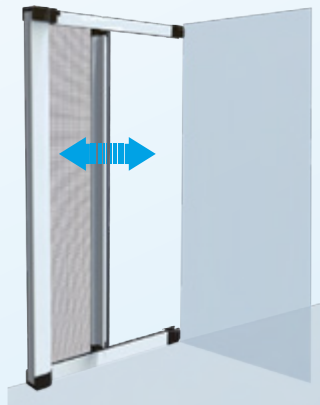

COSI ZENA P.77
POUR PORTE-FENÊTRES



COSI SERENA P.78
POUR BAIES VITRÉES

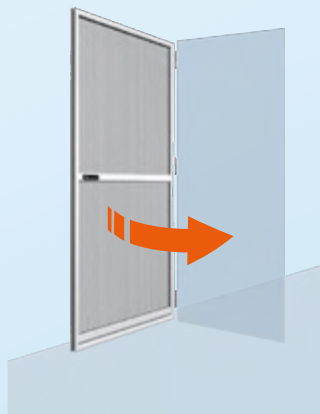

GARDEN P.78
POUR PORTES



INSTALLATION
RAPIDE



KITS
RECUPABLES



VIDÉOS
D'INSTALLATION

MOUSTIQUAIRES POUR VOLET ROULANT



FIXATION FACILE SUR LA BASE DU VOLET

CADRE ALUMINIUM BLANC - TOILE PLISSÉE GRISE

- Extension maximum 1600 mm.
- **Modèle universel** compatible avec rails traditionnels et rénovation.
- Faible encombrement.

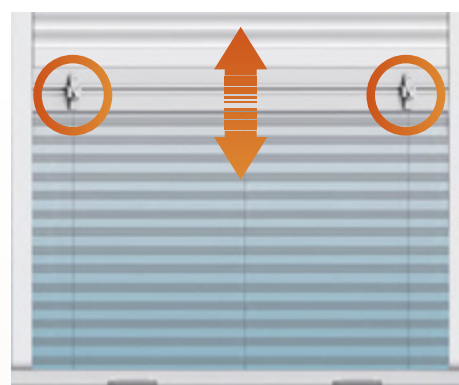
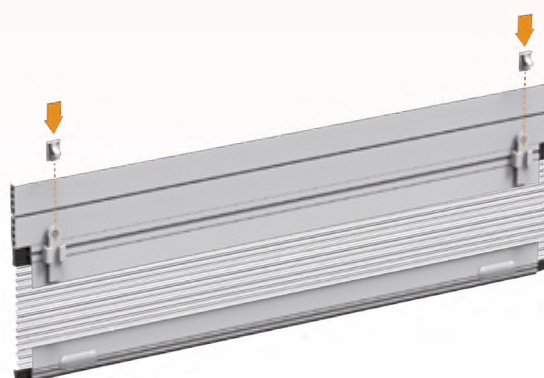

Extension
maxi. 1600 mm

L
de 500 à 1600 mm

POUR VOLET ROULANT

L1000
MM

Réf. 403101

L1400
MM

Réf. 403102

L1600
MM

Réf. 403103





MOUSTIQUAIRES POUR VOLET ROULANT FIXATION FACILE SUR LA BASE DU VOLET

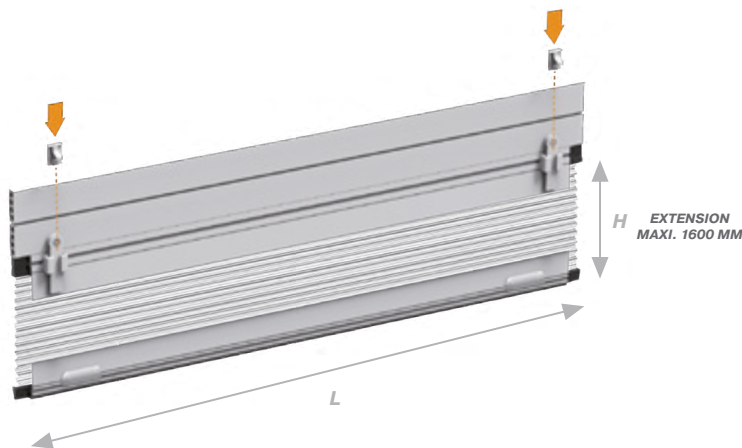

Moustiquaire COSI UP - Pour volet roulant

Code	Gencod		L	H	Type packaging	
403101	3308184031016	9010	1000	1600		10
403102	3308184031023	9010	1300	1600	Vrac gencodé	10
403103	3308184031030	9010	1600	1600		4



3 KITS RECOURPABLES

3 dimensions sont disponibles pour les volets roulants. Les kits comprennent tous les accessoires nécessaires pour le montage et sont recoupables en largeur (mini 500 mm).
EXTENSION MAXI. EN HAUTEUR : 1600 MM



PALBOX Carton à composer - Moustiquaires COSI UP

Code	Gencod	Type packaging	
401129		Palbox carton VIDE	

Minimum d'achat de 1000 € HT net de moustiquaires COSI UP.

DERBY

MOUSTIQUAIRES POUR VOILET ROULANT
POSE FACILE



Moustiquaire extensible Derby – Pour volets roulants

Code	Gencod		L	H	Type packaging	
403115	8028250105735		700-1320	500	Vrac gencodé	10

NON RECOURABLE
STRUCTURE ALU - TOILE FIBRE DE VERRE

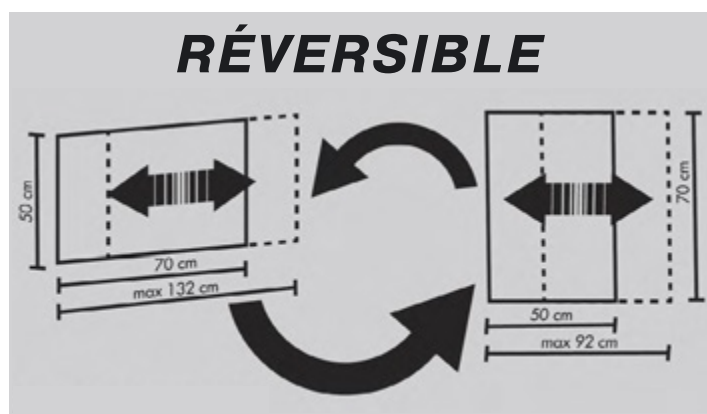



RIDEAUX MOUSTIQUAIRES FERMETURE MAGNÉTIQUE



Moustiquaire Bazar - Pour fenêtres*

Code	Gencod		L	H	Type packaging	
404101	8028250333459		1500	1800	Brochable	1
404102	8028250333466		1500	1800	gencodé	1

* Fermeture magnétique au milieu du rideau sur la longueur.



TOILE DÉCOUPABLE POUR S'ADAPTER À VOS FENÊTRES

- Fixation facile auto-agrippante (fournie)
- Fermeture magnétique au milieu du rideau sur la longueur



Moustiquaire Bazar - Pour porte-fenêtres*

Code	Gencod		L	H	Type packaging	
404103	8028250338744		1200	2400	Brochable	1
404104	8028250317701		1200	2400	gencodé	1

* Fermeture magnétique au milieu du rideau sur la longueur.

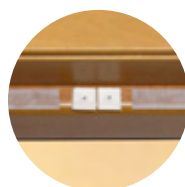

FIXATION FACILE

Double face et punaises inversées
avec bouchons de protections (fournis)

ROTOLO



TOILE DE MOUSTIQUAIRE

Toile moustiquaire Rotolo – Pour fenêtres

Code	Gencod		L	H	Type packaging	
405121	8028250338195	<input type="checkbox"/>	800	2500	Vrac gencodé	9
405122	8028250282474	<input type="checkbox"/>	1200	2500		9
405123	8028250338218	<input type="checkbox"/>	800	2500		9
405124	8028250282498	<input type="checkbox"/>	1200	2500		9

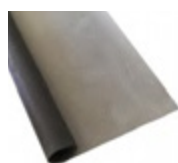

TOILE FIBRE DE VERRE

MOSKITO

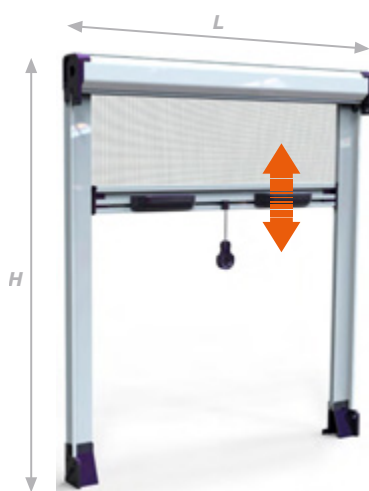
MOUSTIQUAIRES ENROULABLES
FIXATION SIMPLE

Moustiquaire Moskito - Pour fenêtres

Code	Gencod		L	H	Type packaging	
405112	8028250319200	<input type="checkbox"/>	1000	1500	Vrac gencodé	30

MOUSTIQUAIRE À ENROULEMENT VERTICAL
STRUCTURE ALU - TOILE FIBRE DE VERRE



L'INTÉRIEUR DE L'HABITAT

LE RANGEMENT

LE RANGEMENT

Consoles - Entraxe 32 mm

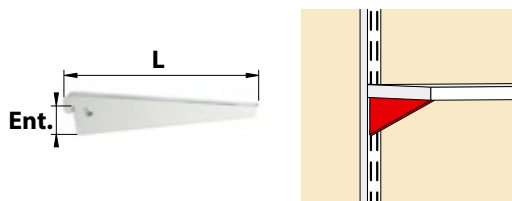

Console double - Entraxe 32 mm

Code	Gencod		L	Ent.	Type packaging	
0971326	3308189713269	<input type="checkbox"/>	120	32	Vrac gencodé	10
0971426	3308189714266	<input type="checkbox"/>	170	32	Vrac gencodé	10
0971526	3308189715263	<input type="checkbox"/>	220	32	Vrac gencodé	10
0968926	3308189689267	<input type="checkbox"/>	270	32	Vrac gencodé	10
0969026	3308189690263	<input type="checkbox"/>	320	32	Vrac gencodé	10
0969126	3308189691260	<input type="checkbox"/>	370	32	Vrac gencodé	10
0971626	3308189716260	<input type="checkbox"/>	470	32	Vrac gencodé	10

Soumis à éco-participation Mobilier.

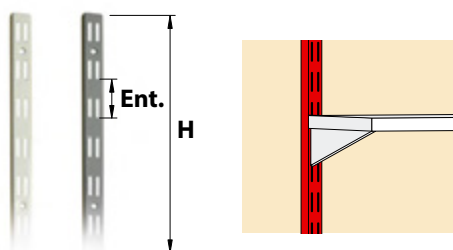

Crémaillère double - Entraxe 32 mm

Code	Gencod		H	Ent.	Type packaging	
0972426	3308189724265	<input type="checkbox"/>	1000	32	Vrac gencodé	10
0972526	3308189725262	<input type="checkbox"/>	1500	32	Vrac gencodé	10
0969226	3308189692267	<input type="checkbox"/>	2000	32	Vrac gencodé	10

Soumis à éco-participation Mobilier.

Consoles - Entraxe 50 mm

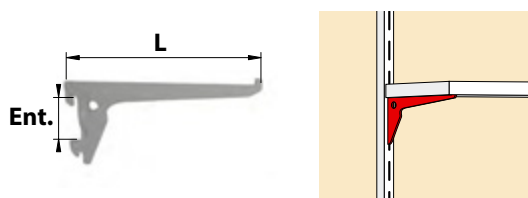

Console simple - Entraxe 50 mm

Code	Gencod		L	Ent.	Type packaging	
1078626	3308180786262	<input type="checkbox"/>	150	50	Vrac gencodé	20
1078726	3308180787269	<input type="checkbox"/>	200	50	Vrac gencodé	10
1078826	3308180788266	<input type="checkbox"/>	250	50	Vrac gencodé	20
1078926	3308180789263	<input type="checkbox"/>	300	50	Vrac gencodé	10
1079026	3308180790269	<input type="checkbox"/>	350	50	Vrac gencodé	10
1079126	3308180791266	<input type="checkbox"/>	400	50	Vrac gencodé	20
1079226	3308180792263	<input type="checkbox"/>	500	50	Vrac gencodé	20

Soumis à éco-participation Mobilier.

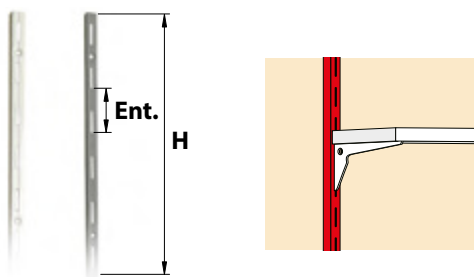

Crémaillère simple - Entraxe 50 mm

Code	Gencod		H	Ent.	Type packaging	
0912526	3308189125260	<input type="checkbox"/>	1000	50	Vrac gencodé	12
0912926	3308189129268	<input type="checkbox"/>	1500	50	Vrac gencodé	12
0913226	3308189132268	<input type="checkbox"/>	2000	50	Vrac gencodé	12

Soumis à éco-participation Mobilier.



L'INTÉRIEUR DE L'HABITAT

L'AMÉNAGEMENT INTÉRIEUR

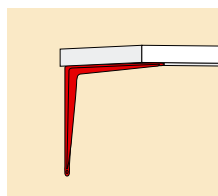
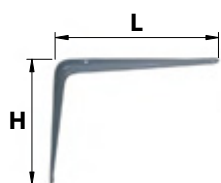

Console emboutie acier

Code	Gencod		L	H	Type packaging	
8021075	3221688021072		100	75	Vrac gencodé	20
8021100	3221688021102		125	100	Vrac gencodé	20
8021125	3221688021126		150	125	Vrac gencodé	20
8021150	3221688021157		200	150	Vrac gencodé	20
8021200	3221688021201		250	200	Vrac gencodé	20
8021250	3221688021256		300	250	Vrac gencodé	20
8021300	3221688021300		350	300	Vrac gencodé	20
8021350	3221688021355		400	350	Vrac gencodé	10
8021400	3221688021409		450	400	Vrac gencodé	10
8121075	3221688121079		100	75	Vrac gencodé	20
8121100	3221688121109		125	100	Vrac gencodé	20
8121125	3221688121123		150	125	Vrac gencodé	20
8121150	3221688121154		200	150	Vrac gencodé	20
8121200	3221688121208		250	200	Vrac gencodé	20
8121250	3221688121253		300	250	Vrac gencodé	20
8121300	3221688121307		350	300	Vrac gencodé	20
8121350	3221688121352		400	350	Vrac gencodé	10
8121400	3221688121406		450	400	Vrac gencodé	10
8221075	3221688221076		100	70	Vrac gencodé	20
8221100	3221688221106		125	100	Vrac gencodé	20
8221125	3221688221120		150	125	Vrac gencodé	20
8221150	3221688221151		200	150	Vrac gencodé	20
8221200	3221688221205		250	200	Vrac gencodé	20
8221250	3221688221250		300	250	Vrac gencodé	20
8221300	3221688221304		350	300	Vrac gencodé	20
x10						
802015	3221688020150		200	150	Vrac gencodé	1 lot de 10 pièces
802020	3221688020204		250	200	Vrac gencodé	1 lot de 10 pièces
802025	3221688020259		300	250	Vrac gencodé	1 lot de 10 pièces

Soumis à éco-participation Mobilier.

Console perfection acier

Code	Gencod		L	H	Type packaging	
021202	3479040212020		125	100	Vrac gencodé	10
021203	3479040212037		150	125	Vrac gencodé	10
021206	3479040212068		250	200	Vrac gencodé	10
021208	3479040212082		350	300	Vrac gencodé	10
021210	3479040212105		450	400	Vrac gencodé	10
021504	3479040215045		200	150	Vrac gencodé	10
021506	3479040215069		250	200	Vrac gencodé	10
021507	3479040215076		300	250	Vrac gencodé	10
021509	3479040215090		400	350	Vrac gencodé	10

Soumis à éco-participation Mobilier.

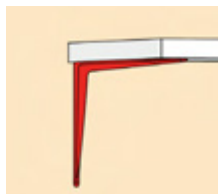
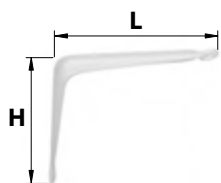

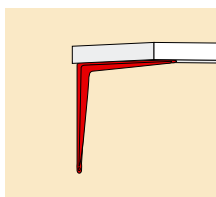
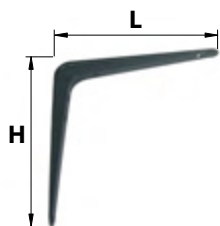

Console colorite acier

Code	Gencod		L	H	Type packaging	
9002501	3479040025019		150	150	Vrac gencodé	5
9002502	3479040025026		200	200	Vrac gencodé	5
9002503	3479040025033		250	250	Vrac gencodé	5
9002521	3479040025217		150	150	Vrac gencodé	5
9002522	3479040025224		200	200	Vrac gencodé	5
9002523	3479040025231		250	250	Vrac gencodé	5
9002531	3479040025316		150	150	Vrac gencodé	5
9002532	3479040025323		200	200	Vrac gencodé	5
002581	3479040025811		150	150	Vrac gencodé	5
002582	3479040025828		200	200	Vrac gencodé	5
9002583	3479040025835		250	250	Vrac gencodé	5

Soumis à éco-participation Mobilier.

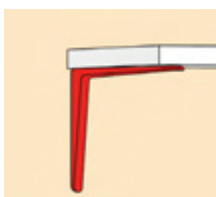
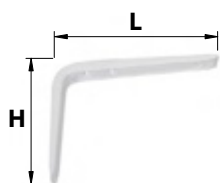

Console renfort 2000 acier

Code	Gencod		L	H	Type packaging	
8068150	3221688068152		150	125	Vrac gencodé	5
8068200	3221688068206		200	150	Vrac gencodé	5
8068250	3221688068251		250	200	Vrac gencodé	5
8068300	3221688068305		300	250	Vrac gencodé	5

Soumis à éco-participation Mobilier.

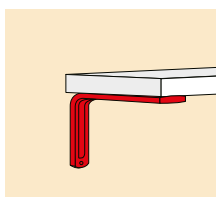
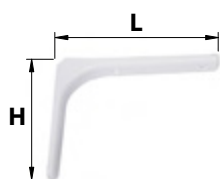

Console moderne acier bouts droits

Code	Gencod		L	H	Type packaging	
8008100	3221688008103		100	100	Vrac gencodé	5
8008125	3221688008127		125	125	Vrac gencodé	5
8008150	3221688008158		150	125	Vrac gencodé	5
8008200	3221688008202		200	150	Vrac gencodé	5
8008250	3221688008257		250	200	Vrac gencodé	5
8008300	3221688008301		300	250	Vrac gencodé	5

Soumis à éco-participation Mobilier.

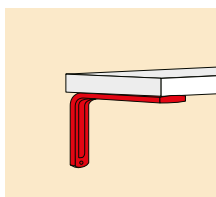
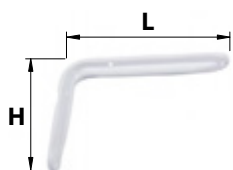

Console new design acier

Code	Gencod		L	H	Type packaging	
8026096	3221688026091		118	96	Vrac gencodé	5
8026110	3221688026114		150	110	Vrac gencodé	5
8026140	3221688026145		200	140	Vrac gencodé	5
8026167	3221688026169		265	167	Vrac gencodé	5
8026177	3221688026176		327	177	Vrac gencodé	5

Soumis à éco-participation Mobilier.

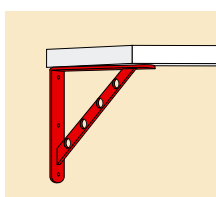
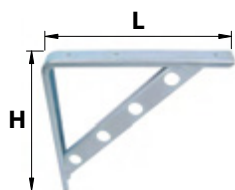

Console TS acier

Code	Gencod		L	H	Type packaging	
9011204	3479040112047		150	150	Vrac gencodé	12
011206	3479040112061		200	200	Vrac gencodé	12
011208	3479040112085		300	300	Vrac gencodé	12

Soumis à éco-participation Mobilier.

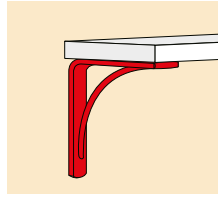
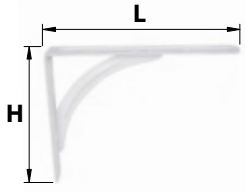

Console robuste acier

Code	Gencod		L	H	Type packaging	
020205	3479040202052	<input type="text"/>	225	175	Vrac gencodé	12
9020206	3479040202069	<input type="text"/>	250	200	Vrac gencodé	12
020207	3479040202076	<input type="text"/>	300	250	Vrac gencodé	10
020208	3479040202083	<input type="text"/>	350	300	Vrac gencodé	10

Soumis à éco-participation Mobilier.

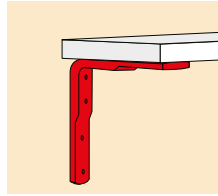
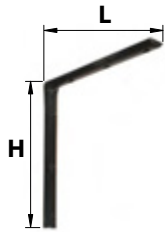

Equerre demi-ronde acier

Code	Gencod		L	I	H	Ep	Type packaging	
0485001	3308184850013	<input type="text"/>	190	20	190	10	Vrac gencodé	1
0485101	3308184851010	<input type="text"/>	250	25	250	10	Vrac gencodé	1
0485201	3308184852017	<input type="text"/>	350	25	350	10	Vrac gencodé	1

Soumis à éco-participation Mobilier.

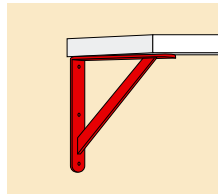
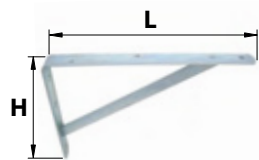

Console lourde charge acier

Code	Gencod		L	H	Type packaging	
Petit modèle						
8030100	3221688030104	<input type="text"/>	150	100	Vrac gencodé	5
8030125	3221688030128	<input type="text"/>	200	125	Vrac gencodé	5
8030150	3221688030159	<input type="text"/>	250	150	Vrac gencodé	5
8130100	3221688130101	<input type="text"/>	150	100	Vrac gencodé	5
8130125	3221688130125	<input type="text"/>	200	125	Vrac gencodé	5
8130150	3221688130156	<input type="text"/>	250	150	Vrac gencodé	5
Grand modèle						
6030180	3221686030182	<input type="text"/>	250	200	Vrac gencodé	5
6030200	3221686030205	<input type="text"/>	300	200	Vrac gencodé	5
6030250	3221686030250	<input type="text"/>	400	250	Vrac gencodé	5
6030330	3221686030335	<input type="text"/>	500	330	Vrac gencodé	5
8030180	3221688030180	<input type="text"/>	250	200	Vrac gencodé	5
8030200	3221688030203	<input type="text"/>	300	200	Vrac gencodé	5
8030250	3221688030258	<input type="text"/>	400	250	Vrac gencodé	5
8030330	3221688030333	<input type="text"/>	500	330	Vrac gencodé	5

Soumis à éco-participation Mobilier.

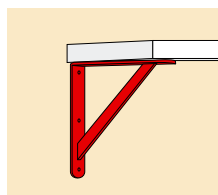
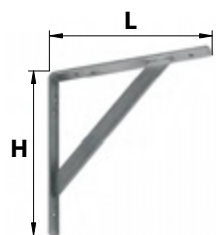

Console renforcée acier

Code	Gencod		L	H	Type packaging	
0183103	3308181831039	<input type="text"/>	200	200	Vrac gencodé	1
0183403	3308181834030	<input type="text"/>	300	300	Vrac gencodé	1
0185503	3308181855035	<input type="text"/>	400	400	Vrac gencodé	1
0183106	3308181831060	<input type="text"/>	200	200	Vrac gencodé	1
0183406	3308181834061	<input type="text"/>	300	300	Vrac gencodé	1
0185506	3308181855066	<input type="text"/>	400	400	Vrac gencodé	1

Soumis à éco-participation Mobilier.

Consoles murales techniques

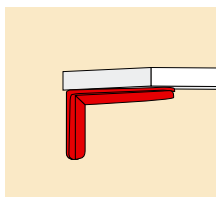

Console très lourde charge acier

Code	Gencod		L	H	Type packaging	
8031250	3221688031255	<input type="checkbox"/>	300	250	Vrac gencodé	5
8031300	3221688031309	<input type="checkbox"/>	400	300	Vrac gencodé	5
6031250	3221686031257	<input checked="" type="checkbox"/> GALVA.	300	250	Vrac gencodé	5
6031300	3221686031301	<input checked="" type="checkbox"/> GALVA.	400	300	Vrac gencodé	5
6031350	3221686031356	<input checked="" type="checkbox"/> GALVA.	550	300	Vrac gencodé	5

Soumis à éco-participation Mobilier.

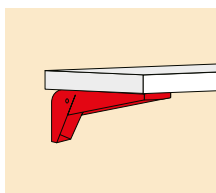

Console escamotable acier

Code	Gencod		L	H	Type packaging	
9002621	3479040026214	<input type="checkbox"/>	200	100	Vrac gencodé	5
9002622	3479040026221	<input type="checkbox"/>	300	130	Vrac gencodé	5
9002623	3479040026238	<input type="checkbox"/>	400	160	Vrac gencodé	5

Soumis à éco-participation Mobilier.

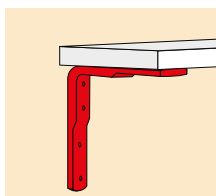
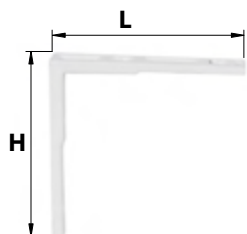

Console simple aluminium

Code	Gencod		L	H	Type packaging	
8002070	3221688002071	<input type="checkbox"/>	70	70	Vrac gencodé	5
8002090	3221688002095	<input type="checkbox"/>	90	90	Vrac gencodé	5
8002135	3221688002132	<input type="checkbox"/>	135	135	Vrac gencodé	5

Soumis à éco-participation Mobilier.

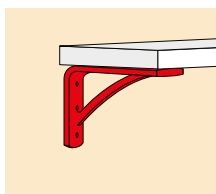

Console renforcée aluminium

Code	Gencod		L	H	Type packaging	
8003200	3221688003207	<input type="checkbox"/>	200	100	Vrac gencodé	10

Soumis à éco-participation Mobilier.

Consoles murales décoratives

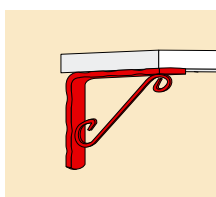
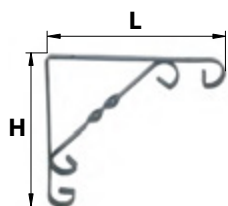

Console décorative acier

Code	Gencod		L	H	Type packaging	
9002701	3479040027013	<input checked="" type="checkbox"/>	100	100	Vrac gencodé	6
002702	3479040027020	<input checked="" type="checkbox"/>	150	150	Vrac gencodé	6
002703	3479040027037	<input checked="" type="checkbox"/>	200	200	Vrac gencodé	6
9002704	3479040027044	<input checked="" type="checkbox"/>	250	250	Vrac gencodé	6
9002741	3479040027419	<input type="checkbox"/>	100	100	Vrac gencodé	6
9002742	3479040027426	<input type="checkbox"/>	150	150	Vrac gencodé	6
9002743	3479040027433	<input type="checkbox"/>	200	200	Vrac gencodé	6
9002744	3479040027440	<input type="checkbox"/>	250	250	Vrac gencodé	6

Soumis à éco-participation Mobilier.

Consoles murales décoratives

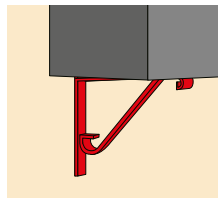
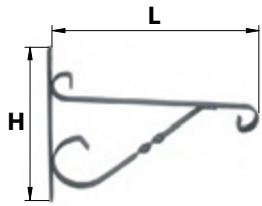

Console support de pots acier

Code	Gencod		L	H	Type packaging	
503664	3479045036645		310	260	Vrac gencodé	6

Soumis à éco-participation Mobilier.

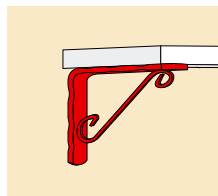
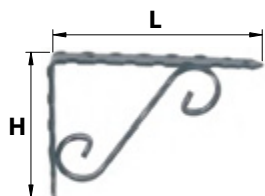

Console fer rustique acier patiné

Code	Gencod		L	H	Type packaging	
8914105	3479048914100	FER PATINÉ	105	105	Vrac gencodé	10
8914115	3479048914117	FER PATINÉ	150	115	Vrac gencodé	10

Soumis à éco-participation Mobilier.

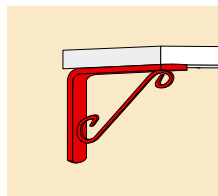
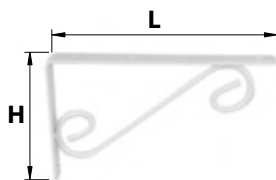

Console volute acier

Code	Gencod		L	H	Type packaging	
503680	3221685036802		150	100	Vrac gencodé	10
503685	3221685036857		200	120	Vrac gencodé	10
503670	3221685036703		150	100	Vrac gencodé	10
503675	3221685036758		200	120	Vrac gencodé	10

Soumis à éco-participation Mobilier.

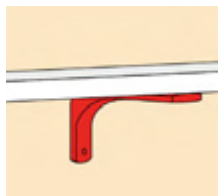
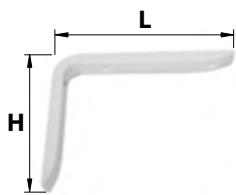

Console moderne courbe aluminium

Code	Gencod		L	H	Type packaging	
9002762	3479040027624		150	125	Vrac gencodé	20
9002763	3479040027631		200	150	Vrac gencodé	20
9002764	3479040027648		250	200	Vrac gencodé	20
9002765	3479040027655		300	250	Vrac gencodé	20
9002772	3479040027723		150	125	Vrac gencodé	20
9002773	3479040027730		200	150	Vrac gencodé	20
9002774	3479040027747		250	200	Vrac gencodé	20

Soumis à éco-participation Mobilier.

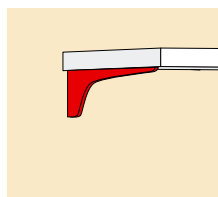

Console contemporaine aluminium

Code	Gencod		L	H	Type packaging	
8069125	3221688069128		125	70	Vrac gencodé	10
8069175	3221688069173		175	90	Vrac gencodé	10
8069225	3221688069227		225	110	Vrac gencodé	10
8569125	3221688569123		125	70	Vrac gencodé	10
8569175	3221688569178		175	90	Vrac gencodé	10
8569225	3221688569222		225	110	Vrac gencodé	10

Soumis à éco-participation Mobilier.

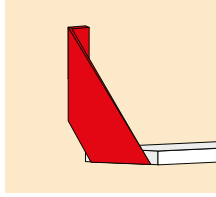
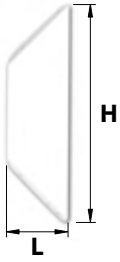

Console bandeau acier

Code	Gencod		L	H	Type packaging	
8051090	3221688051093		90	230	Vrac gencodé	10
8151090	3221688151090		90	230	Vrac gencodé	10
8551090	3221688551098		90	230	Vrac gencodé	10

Soumis à éco-participation Mobilier.

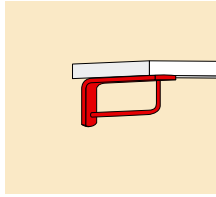
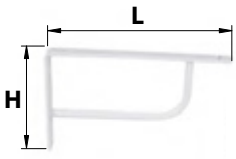

Console 1/4 cercle ovale acier

Code	Gencod		L	H	Type packaging	
007121	3479040071214		125	200	Vrac gencodé	6
007122	3479040071221		150	250	Vrac gencodé	6
007131	3479040071313		125	200	Vrac gencodé	10
007132	3479040071320		150	250	Vrac gencodé	10

Soumis à éco-participation Mobilier.

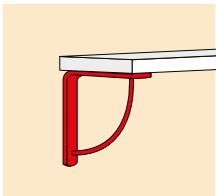
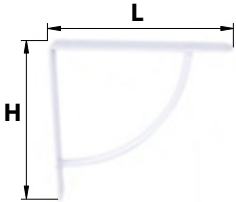

Console 1/4 cercle simple acier

Code	Gencod		L	H	Type packaging	
007221	3479040072211		180	180	Vrac gencodé	6
007222	3479040072228		230	230	Vrac gencodé	6
007231	3479040072310		180	180	Vrac gencodé	6
007271	3479040072716		180	180	Vrac gencodé	6
007272	3479040072723		230	230	Vrac gencodé	6
007281	3479040072815	CHROME	180	180	Vrac gencodé	6
007282	3479040072822	CHROME	230	230	Vrac gencodé	6

Soumis à éco-participation Mobilier.

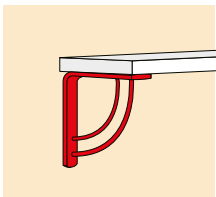
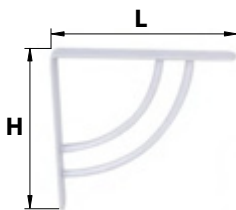

Console 1/4 cercle double acier

Code	Gencod		L	H	Type packaging	
007321	3479040073218		180	180	Vrac gencodé	10
007322	3479040073225		230	230	Vrac gencodé	10
007381	3479040073812	CHROME	180	180	Vrac gencodé	6

Soumis à éco-participation Mobilier.

Consoles murales bois

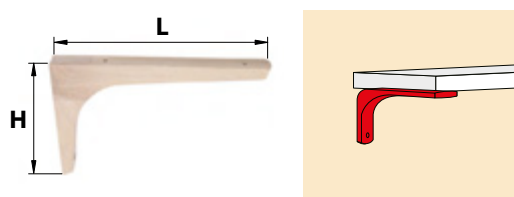
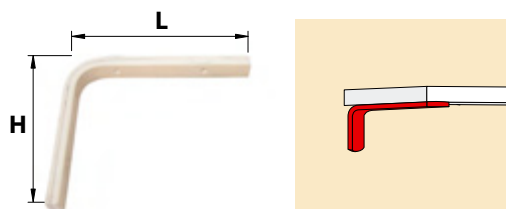
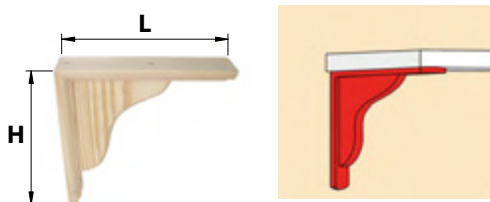
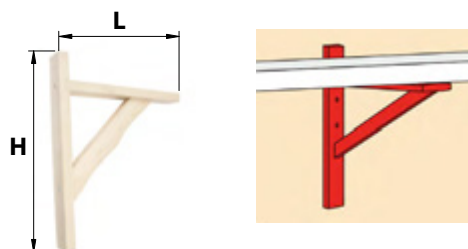
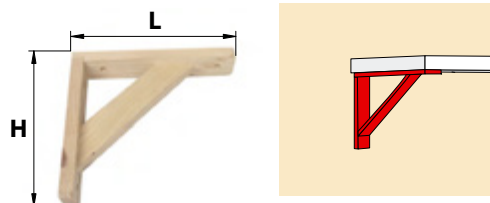
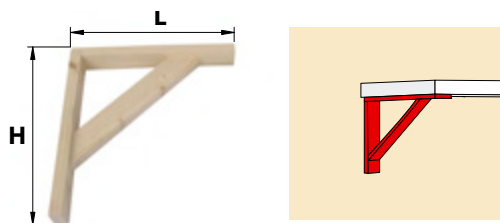

Console bois éco pin brut

Code	Gencod		L	H	Type packaging	
902013	3221689020135	BRUT	150	135	Vrac gencodé	6
902017	3221689020173	BRUT	190	175	Vrac gencodé	6
902023	3221689020234	BRUT	250	235	Vrac gencodé	6

Soumis à éco-participation Mobilier.

Console bois pratic pin brut

Code	Gencod		L	H	Type packaging	
902213	3221689022139	BRUT	150	135	Vrac gencodé	6
902217	3221689022177	BRUT	190	175	Vrac gencodé	6
902223	3221689022238	BRUT	250	235	Vrac gencodé	6

Soumis à éco-participation Mobilier.

Console bois rustique

Code	Gencod		L	H	Type packaging	
Pin brut						
9014170	3221689014172	BRUT	230	170	Vrac gencodé	6
9014230	3221689014233	BRUT	280	230	Vrac gencodé	6
9014280	3221689014288	BRUT	320	280	Vrac gencodé	6
Hêtre						
9013170	3221689013175	BRUT	230	170	Vrac gencodé	6
9013230	3221689013236	BRUT	280	230	Vrac gencodé	6
9013280	3221689013281	BRUT	320	280	Vrac gencodé	6

Soumis à éco-participation Mobilier.

Console bois rustique plein pin brut

Code	Gencod		L	H	Type packaging	
9018150	3221689018156	BRUT	150	150	Vrac gencodé	10
9018200	3221689018200	BRUT	200	200	Vrac gencodé	10
9018250	3221689018255	BRUT	250	250	Vrac gencodé	10

Soumis à éco-participation Mobilier.

Console bois lamellée hêtre

Code	Gencod		L	H	Type packaging	
921515	3221689215159	BRUT	170	150	Vrac gencodé	6
921517	3221689215173	BRUT	200	175	Vrac gencodé	6
921520	3221689215203	BRUT	250	200	Vrac gencodé	6
921529	3221689215296	BRUT	200	290	Vrac gencodé	6

Soumis à éco-participation Mobilier.

Console bois moderne hêtre

Code	Gencod		L	H	Type packaging	
9016100	3221689016107	BRUT	150	100	Vrac gencodé	6
9016125	3221689016121	BRUT	200	125	Vrac gencodé	6
9016150	3221689016152	BRUT	250	150	Vrac gencodé	6
9016200	3221689016206	BRUT	300	200	Vrac gencodé	6

Soumis à éco-participation Mobilier.

Porte-chapeaux

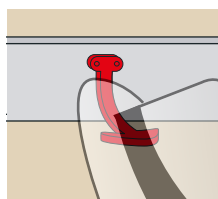

Porte-chapeau embouti acier

Code	Gencod		H	L	Type packaging	
8029078	3221688029078		80	60	Vrac gencodé	10
8529078	3221688529073		80	60	Vrac gencodé	10
8229078	3221688229072		80	60	Vrac gencodé	10

Soumis à éco-participation Mobilier.

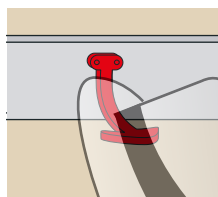
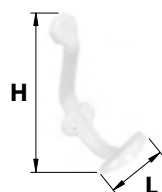

Porte-chapeau embouti long acier

Code	Gencod		H	L	Type packaging	
8027160	3221688027166		150	60	Vrac gencodé	10
8527160	3221688527161		150	60	Vrac gencodé	10
8227160	3221688227160		150	60	Vrac gencodé	10

Soumis à éco-participation Mobilier.

Crochets décoratifs

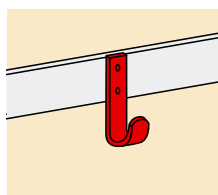

Crochet décoratif acier

Code	Gencod		H	L	Type packaging	
8053045	3221688053042		45	15	Vrac gencodé	10
8070070	3221688070070		70	20	Vrac gencodé	10
8052095	3221688052090		95	30	Vrac gencodé	10
8553045	3221688553047		45	15	Vrac gencodé	10
8570070	3221688570075		70	20	Vrac gencodé	10
8552095	3221688552095		95	30	Vrac gencodé	10

Soumis à éco-participation Mobilier.

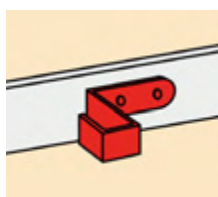
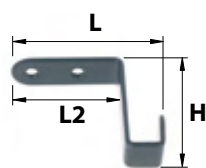

Crochet décoratif coudé acier



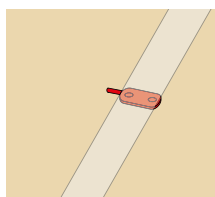
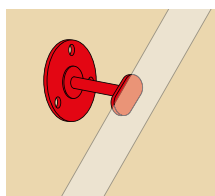
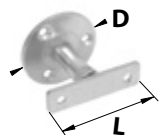
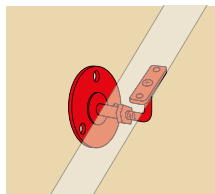
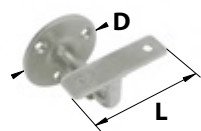
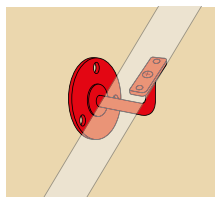
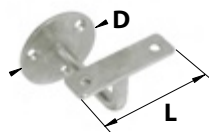

Code	Gencod		L	L2	H	Type packaging	
8554040	3221688554044		53	40,5	39	Vrac gencodé	10

Soumis à éco-participation Mobilier.



Supports de rampe



Support de rampe coudé fixe à visser

Code	Gencod	 D plaque ronde	L	Type packaging		
Ø10 - Déport 75 mm						
529880	3479045298807		60	60	Vrac gencodé	5
529870	3479045298708	Z.BLANC	60	60	Vrac gencodé	5
Ø12 - Déport 55 mm						
529875	3479045298753	Z.BLANC	60	60	Vrac gencodé	5
Ø12 - Déport 85 mm						
0260703	3308182607039	Z.BLANC	60	60		10

Support de rampe coudé réglable à visser

Code	Gencod	 D plaque ronde	L	Type packaging		
Ø10 - Déport réglable 55-70 mm						
529885	3479045298852	Z.BLANC	60	70	Vrac gencodé	5
0455803	3308184558032	Z.BLANC	60	70		10

Support de rampe droit réglable à visser

Code	Gencod	 D plaque ronde	L	Type packaging		
Ø12 - Déport réglable 55-75 mm						
529890	3479045298906	Z.BLANC	60	70	Vrac gencodé	10

Fixation de rampe à vis (x2)

Code	Gencod	 D	Type packaging	
633801	3026726338019	Z.BLANC	Vrac gencodé	5 sachets 2 pièces





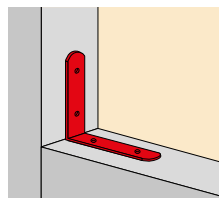
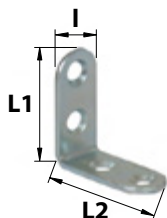

L'INTÉRIEUR DE L'HABITAT

LA QUINCAILLERIE



Equerre de chaise

Code	Gencod		L1	L2	I	Ep.	Type packaging	
9001156	3479040011562	GALVA.	24	24	14	1,5	Vrac gencodé	25
6117030	3221686117036	GALVA.	30	30	14	2	Vrac gencodé	25
6117040	3221686117043	GALVA.	40	40	14	2	Vrac gencodé	25
6117050	3221686117050	GALVA.	50	50	14	2	Vrac gencodé	25
6117060	3221686117067	GALVA.	60	60	14	2	Vrac gencodé	25
6117070	3221686117074	GALVA.	70	70	16	2	Vrac gencodé	25
6117080	3221686117081	GALVA.	80	80	16	2	Vrac gencodé	25
6117090	3221686117098	GALVA.	90	90	18	3	Vrac gencodé	25
6117100	3221686117104	GALVA.	100	100	18	3	Vrac gencodé	25
6117120	3221686117128	GALVA.	120	120	18	3	Vrac gencodé	25
6117140	3221686117142	GALVA.	140	140	18	3	Vrac gencodé	25
8017030	3221688017037	EPOXY	30	30	14	2	Vrac gencodé	25
8017040	3221688017044	EPOXY	40	40	14	2	Vrac gencodé	25
8017050	3221688017051	EPOXY	50	50	14	2	Vrac gencodé	25
8017060	3221688017068	EPOXY	60	60	14	2	Vrac gencodé	25
8017070	3221688017075	EPOXY	70	70	16	2	Vrac gencodé	25
8017080	3221688017082	EPOXY	80	80	16	2	Vrac gencodé	25
8017100	3221688017105	EPOXY	100	100	18	3	Vrac gencodé	25
8517030	3221688517032		30	30	14	2	Vrac gencodé	25
8517040	3221688517049		40	40	14	2	Vrac gencodé	25
8517050	3221688517056		50	50	14	2	Vrac gencodé	25
8517060	3221688517063		60	60	14	2	Vrac gencodé	25
8517070	3221688517070		70	70	16	2	Vrac gencodé	25
8517080	3221688517087		80	80	16	2	Vrac gencodé	25
8517100	3221688517100		100	100	18	3	Vrac gencodé	25
011540	3479040115406	LAITONNÉ	30	30	14	2	Vrac gencodé	25
011541	3479040115413	LAITONNÉ	40	40	14	2	Vrac gencodé	25
011542	3479040115420	LAITONNÉ	50	50	14	2	Vrac gencodé	25
011543	3479040115437	LAITONNÉ	60	60	14	2	Vrac gencodé	25
8817030	3221688817033	LAITON	30	30	14	3	Vrac gencodé	25
8817040	3221688817040	LAITON	40	40	14	3	Vrac gencodé	25
8817050	3221688817057	LAITON	50	50	14	3	Vrac gencodé	25
8817060	3221688817064	LAITON	60	60	14	3	Vrac gencodé	25
x10								
0422402	3308184224029	GALVA.	30	30	14	2		1 boîte 20 sachets
0422702	3308184227020	GALVA.	60	60	14	2		1 boîte 20 sachets
x25								
0115625	3479042011560	GALVA.	24	24	14	1,5	Vrac gencodé	1 sachet 25 pièces
25617030	3221682517038	GALVA.	30	30	14	2	Vrac gencodé	1 sachet 25 pièces
25617040	3221682517045	GALVA.	40	40	14	2	Vrac gencodé	1 sachet 25 pièces
25617050	3221682517052	GALVA.	50	50	14	2	Vrac gencodé	1 sachet 25 pièces
25617060	3221682517069	GALVA.	60	60	14	2	Vrac gencodé	1 sachet 25 pièces
25617070	3221682517076	GALVA.	70	70	16	2	Vrac gencodé	1 sachet 25 pièces
25617080	3221682517083	GALVA.	80	80	16	2	Vrac gencodé	1 sachet 25 pièces
0330902	3308183309024	GALVA.	30	30	14	2		1 boîte 200 pièces
0331102	3308183311027	GALVA.	40	40	14	2		1 boîte 200 pièces
0331202	3308183312024	GALVA.	50	50	14	2		1 boîte 200 pièces
0331302	3308183313021	GALVA.	60	60	14	2		1 boîte 200 pièces
x100								
0331402	3308183314028	Z.BLANC	70	70	16	2		1 boîte 100 pièces
0331502	3308183315025	Z.BLANC	80	80	16	2		1 boîte 100 pièces
0331602	3308183316022	Z.BLANC	90	90	18	3		1 boîte 100 pièces
0331702	3308183317029	Z.BLANC	100	100	18	3		1 boîte 100 pièces
0331902	3308183319023	Z.BLANC	120	120	18	3		1 boîte 100 pièces
0332102	3308183321026	Z.BLANC	140	140	18	3		1 boîte 50 pièces

Soumis à éco-participation Mobilier.

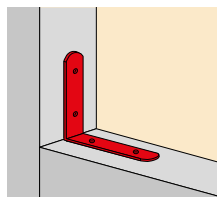
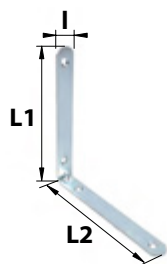

Equerre de chaise renforcée

Code	Gencod		L1	L2	I	Ep.	Type packaging	
675014	3026726750149	GALVA	160	160	20	2,5	Vrac gencodé	20

Soumis à éco-participation Mobilier.

Equerre de renfort

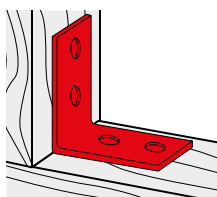
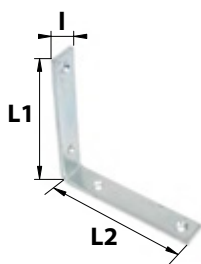

Code	Gencod		L1	L2	I	Ep.	Type packaging	
6217050	3221686217057	Z.BLANC	50	50	18	4	Vrac gencodé	25
6217070	3221686217071	Z.BLANC	70	70	18	4	Vrac gencodé	25
6217100	3221686217101	Z.BLANC	100	100	18	4	Vrac gencodé	25
6217120	3221686217125	Z.BLANC	120	120	18	4	Vrac gencodé	25
6217140	3221686217149	Z.BLANC	140	140	18	4	Vrac gencodé	25
6217160	3221686217163	Z.BLANC	160	160	18	4	Vrac gencodé	25
6217190	3221686217194	Z.BLANC	190	190	20	4	Vrac gencodé	25
6217220	3221686217224	Z.BLANC	220	220	20	4	Vrac gencodé	25
6217250	3221686217255	Z.BLANC	250	250	20	4	Vrac gencodé	25
8062050	3221688062051		50	50	18	4	Vrac gencodé	25
8062070	3221688062075		70	70	18	4	Vrac gencodé	25
8062100	3221688062105		100	100	18	4	Vrac gencodé	25
8062120	3221688062129		120	120	18	4	Vrac gencodé	25
8062140	3221688062143		140	140	18	4	Vrac gencodé	25
8062160	3221688062167		160	160	18	4	Vrac gencodé	25
8062190	3221688062198		190	190	18	4	Vrac gencodé	25

Equerre de châssis

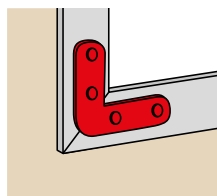
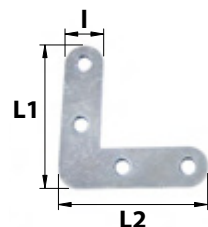

Code	Gencod		L1	L2	I	Ep.	Type packaging	
C218040	3221686218047	Z.BLANC	40	40	10	1,5	Vrac gencodé	25
6218060	3221686218061	Z.BLANC	60	60	16	1,5	Vrac gencodé	25
6218080	3221686218085	Z.BLANC	80	80	16	1,5	Vrac gencodé	25
6218100	3221686218108	Z.BLANC	100	100	16	2	Vrac gencodé	25
x10								
6218120	3221686218122	Z.BLANC	120	120	20	2	Vrac gencodé	1 sachet 10 pièces
6218140	3221686218146	Z.BLANC	140	140	22	2	Vrac gencodé	1 sachet 10 pièces
6218160	3221686218160	Z.BLANC	160	160	22	2	Vrac gencodé	1 sachet 10 pièces
6218190	3221686218191	Z.BLANC	190	190	22	2	Vrac gencodé	1 sachet 10 pièces
6218220	3221686218221	Z.BLANC	220	220	22	2	Vrac gencodé	1 sachet 10 pièces
x25								
25618004	3221682518400	Z.BLANC	40	40	10	1,5	Vrac gencodé	1 sachet 25 pièces

Soumis à éco-participation Mobilier.

Equerre de châssis coudée

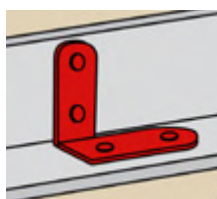
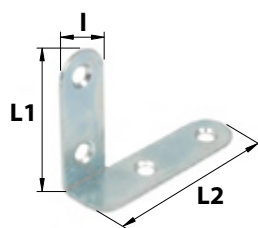

Modèle gauche

Code	Gencod		L1	L2	I	Ep.	Type packaging	
Droite								
6318140	3221686318143	Z.BLANC	40	40	10	1,5	Vrac gencodé	25
6318160	3221686318167	Z.BLANC	60	60	16	1,5	Vrac gencodé	25
6318180	3221686318181	Z.BLANC	80	80	16	1,5	Vrac gencodé	25
Gauche								
6318240	3221686318242	Z.BLANC	40	40	10	1,5	Vrac gencodé	25
6318260	3221686318266	Z.BLANC	60	60	16	1,5	Vrac gencodé	25
6318280	3221686318280	Z.BLANC	80	80	16	1,5	Vrac gencodé	25

Soumis à éco-participation Mobilier.

Equerres en T

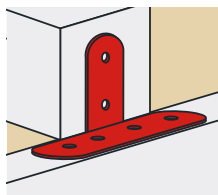
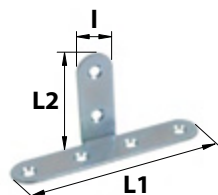
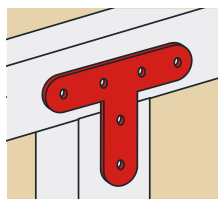
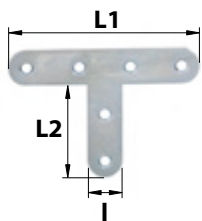

Equerre en T

Code	Gencod		L1	L2	I	Ep.	Type packaging	
6226040	3221686326042	Z.BLANC	80	40	15	1,5	Vrac gencodé	25

Soumis à éco-participation Mobilier.

Equerre en T cambrée

Code	Gencod		L1	L2	I	Ep.	Type packaging	
Fraisage intérieur								
6326040	3221686326049	Z.BLANC	80	30	15	1,5	Vrac gencodé	25
Fraisage extérieur								
6327040	3221686327046	Z.BLANC	80	30	15	1,5	Vrac gencodé	25

Soumis à éco-participation Mobilier.

Equerres

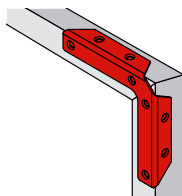
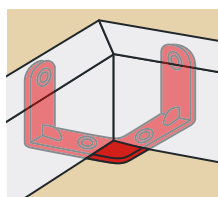
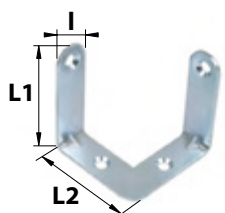

Equerre de coin

Code	Gencod		L1	L2	I	Ep.	Type packaging	
011494	3479040114942	Z.BLANC	50	50	16	1,5	Vrac gencodé	25

Soumis à éco-participation Mobilier.

Equerre de cadre

Code	Gencod		L1	L2	Ep.	Type packaging	
677812	3026726778129	Z.BLANC	120	120	2	Vrac gencodé	10
677816	3026726778167	Z.BLANC	160	160	2	Vrac gencodé	10
677820	3026726778204	Z.BLANC	200	200	2	Vrac gencodé	10
0901001	3308189010016		120	120	2	Vrac gencodé	10
0903001	3308189030014		160	160	2	Vrac gencodé	10
0903101	3308189031011		200	200	2	Vrac gencodé	10

Equerre de caisse

Code	Gencod		L1	L2	I	Ep.	Type packaging	
6319100	3221686319102	Z.BLANC	100	100	25	2	Vrac gencodé	25
6319120	3221686319126	Z.BLANC	120	120	25	2	Vrac gencodé	25

Soumis à éco-participation Mobilier.

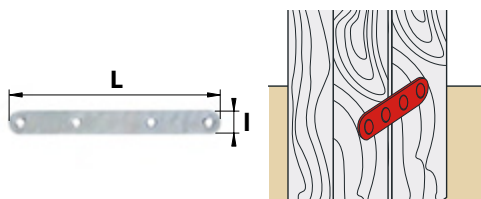

Patte d'assemblage

Code	Gencod		L	I	Ep.	Type packaging	
6118060	3221686118064	GALVA.	60	14	2	Vrac gencodé	25
6118080	3221686118088	GALVA.	80	14	2	Vrac gencodé	25
6118100	3221686118101	GALVA.	100	14	2	Vrac gencodé	25
6118120	3221686118125	GALVA.	120	14	2	Vrac gencodé	25
6118140	3221686118149	GALVA.	140	16	2	Vrac gencodé	25
6118160	3221686118163	GALVA.	160	16	2	Vrac gencodé	25
6118180	3221686118187	GALVA.	180	18	3	Vrac gencodé	25
6118200	3221686118200	GALVA.	200	18	3	Vrac gencodé	25
x25							
25618060	3221682518066	GALVA.	60	14	2	Vrac gencodé	1 sachet 25 pièces
25618080	3221682518080	GALVA.	80	14	2	Vrac gencodé	1 sachet 25 pièces
25618100	3221682518103	GALVA.	100	14	2	Vrac gencodé	1 sachet 25 pièces
25618120	3221682518127	GALVA.	120	14	2	Vrac gencodé	1 sachet 25 pièces

Soumis à éco-participation Mobilier.

Equerres d'assemblage

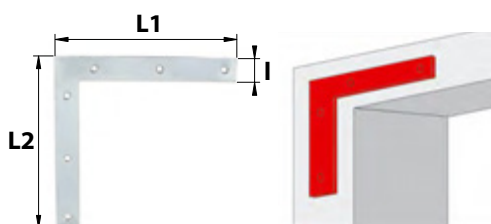

Equerre de fenêtre

Code	Gencod		L1	L2	I	Ep.	Type packaging	
6418100	3221686418102	Z.BLANC	100	100	22	2	Vrac gencodé	10
6418120	3221686418126	Z.BLANC	120	120	22	2	Vrac gencodé	10
6418140	3221686418140	Z.BLANC	140	140	22	2	Vrac gencodé	10
6418160	3221686418164	Z.BLANC	160	160	22	2	Vrac gencodé	10
6418190	3221686418195	Z.BLANC	190	190	22	2	Vrac gencodé	10
6418220	3221686418225	Z.BLANC	220	220	23	2	Vrac gencodé	10

Equerre découpée

Code	Gencod		L1	L2	I	Ep.	Type packaging	
656111	3479046561115	Z.BLANC	220	220	24	3	Vrac gencodé	6
656116	3479046561160	Z.BLANC	250	250	24	3	Vrac gencodé	6
656121	3479046561214	Z.BLANC	300	300	24	3	Vrac gencodé	6
656110	3479046561108		220	220	24	3	Vrac gencodé	6
656115	3479046561153		250	250	24	3	Vrac gencodé	6
656120	3479046561207		300	300	24	3	Vrac gencodé	6

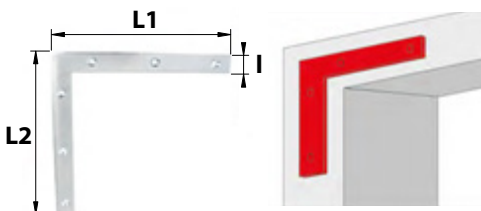

Charnières

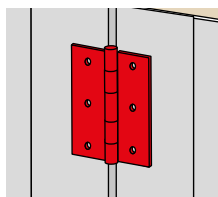
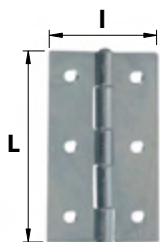
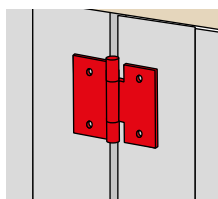
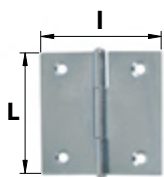

Charnière de meuble carrée

Code	Gencod		L	I	Ep.	Type packaging	
9242100	3479042421000	BRUT	30	30	0,8	Vrac gencodé	50
242110	3479042421109	BRUT	40	40	0,9	Vrac gencodé	50
242120	3479042421208	BRUT	50	50	0,9	Vrac gencodé	25
242130	3479042421307	BRUT	60	60	1,2	Vrac gencodé	25
242140	3479042421406	BRUT	70	70	1,2	Vrac gencodé	25
242150	3479042421505	BRUT	80	80	1,2	Vrac gencodé	25
9541600	3479045416003	Z.BLANC	30	30	0,8	Vrac gencodé	50
541610	3479045416102	Z.BLANC	40	40	0,9	Vrac gencodé	50
541620	3479045416201	Z.BLANC	50	50	0,9	Vrac gencodé	25
541630	3479045416300	Z.BLANC	60	60	1,2	Vrac gencodé	25
541640	3479045416409	Z.BLANC	70	70	1,2	Vrac gencodé	25
541650	3479045416508	Z.BLANC	80	80	1,2	Vrac gencodé	25

Soumis à éco-participation Mobilier.

Charnière de meuble rectangulaire

Code	Gencod		L	I	Ep.	Type packaging	
242010	3479042420102	BRUT	30	19	0,8	Vrac gencodé	50
242030	3479042420300	BRUT	40	25	0,9	Vrac gencodé	25
242040	3479042420409	BRUT	50	30	0,9	Vrac gencodé	25
242050	3479042420508	BRUT	60	35	1	Vrac gencodé	25
242060	3479042420607	BRUT	70	40	1,2	Vrac gencodé	25
242070	3479042420706	BRUT	80	45	1,2	Vrac gencodé	25
242090	3479042420904	BRUT	100	50	1,5	Vrac gencodé	25
541500	3479045415006	Z.BLANC	25	18	0,8	Vrac gencodé	50
541510	3479045415105	Z.BLANC	30	19	0,8	Vrac gencodé	50
541520	3479045415204	Z.BLANC	35	22	0,8	Vrac gencodé	25
541530	3479045415303	Z.BLANC	40	25	0,9	Vrac gencodé	25
541540	3479045415402	Z.BLANC	50	30	0,9	Vrac gencodé	25
541550	3479045415501	Z.BLANC	60	35	1	Vrac gencodé	25
541560	3479045415600	Z.BLANC	70	40	1,2	Vrac gencodé	25
541570	3479045415709	Z.BLANC	80	45	1,2	Vrac gencodé	25
541580	3479045415808	Z.BLANC	90	45	1,5	Vrac gencodé	25
541590	3479045415907	Z.BLANC	100	50	1,5	Vrac gencodé	25
541820	3479045418205	LAITONNÉ	25	18	0,8	Vrac gencodé	50
541830	3479045418304	LAITONNÉ	30	19	0,8	Vrac gencodé	50
541840	3479045418403	LAITONNÉ	35	22	0,8	Vrac gencodé	25
541850	3479045418502	LAITONNÉ	40	25	0,9	Vrac gencodé	25
541860	3479045418601	LAITONNÉ	50	30	0,9	Vrac gencodé	25
541870	3479045418700	LAITONNÉ	60	35	1	Vrac gencodé	25
541880	3479045418809	LAITONNÉ	70	40	1,2	Vrac gencodé	25
541890	3479045418908	LAITONNÉ	80	45	1,2	Vrac gencodé	25
9541900	3479045419004	LAITONNÉ	90	45	1,5	Vrac gencodé	25
541910	3479045419103	LAITONNÉ	100	50	1,5	Vrac gencodé	25

Soumis à éco-participation Mobilier.

Agrafes

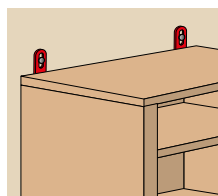
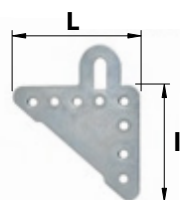
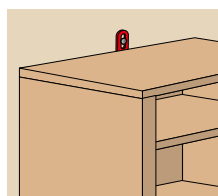
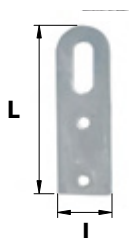

Agrafe pour étagère

Code	Gencod		L	I	Ep.	Type packaging	
008331	3479040083316	Z.BLANC	50	22	1,5	Vrac gencodé	25
008332	3479040083323	Z.BLANC	60	22	1,5	Vrac gencodé	25
6102075	3221686102070	Z.BLANC	75	25	1,5	Vrac gencodé	25

Soumis à éco-participation Mobilier.

Agrafe triangulaire universelle

Code	Gencod		L	I	Ep.	Type packaging	
6107031	3221686107037	Z.BLANC	95	60	2	Vrac gencodé	25

Soumis à éco-participation Mobilier.

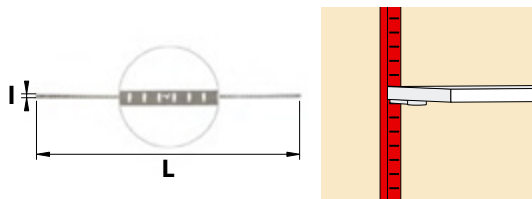

Crémaillère de meuble

Code	Gencod		L	I	Type packaging	
544520	3479045445201	NICKELÉ	2000	16	Vrac gencodé	10
544530	3479045445300	LAITONNÉ	2000	16	Vrac gencodé	10

Soumis à éco-participation Mobilier.

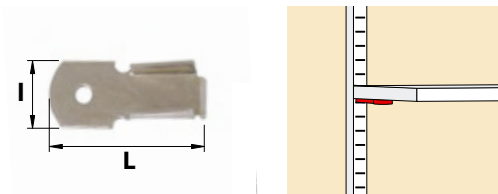

Taquet pour crémaillère (x20)

Code	Gencod		L	I	Ep.	Type packaging	
544540	3479045445409	NICKELÉ	30,8	10,6	1,2	Vrac gencodé	10 sachets 20 pièces
544550	3479045445508	LAITONNÉ	30,8	10,6	1,2	Vrac gencodé	10 sachets 20 pièces

Soumis à éco-participation Mobilier.

Charnières à piano

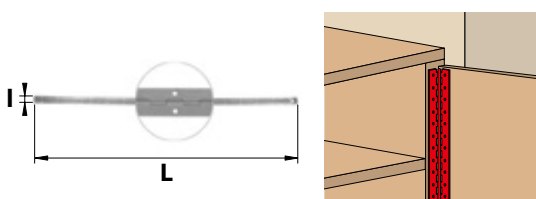

Charnière à piano

Code	Gencod		L	I	Type packaging	
542475	3479045424756	NICKELÉ	960	32	Vrac gencodé	10
542540	3479045425401	NICKELÉ	1980	32	Vrac gencodé	10
9542600	3479045426002	NICKELÉ	1980	40	Vrac gencodé	10
542445	3479045424459	LAITONNÉ	480	25	Vrac gencodé	10
542455	3479045424558	LAITONNÉ	960	25	Vrac gencodé	10
542470	3479045424701	LAITONNÉ	1980	25	Vrac gencodé	10
542485	3479045424855	LAITONNÉ	480	32	Vrac gencodé	10
542495	3479045424954	LAITONNÉ	960	32	Vrac gencodé	10
542550	3479045425500	LAITONNÉ	1980	32	Vrac gencodé	10
542610	3479045426101	LAITONNÉ	1980	40	Vrac gencodé	10

Soumis à éco-participation Mobilier.

Charnières de caisse

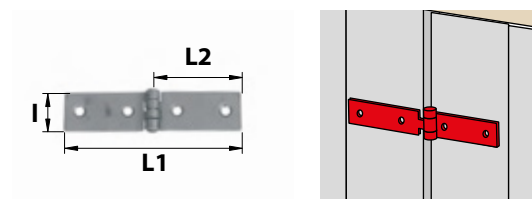

Charnière de caisse à coulisse

Code	Gencod		L1	L2	I	Ep.	Type packaging	
542270	3479045422707	Z.BLANC	80	36,5	20	1,2	Vrac gencodé	25
542280	3479045422806	Z.BLANC	100	45	22	1,5	Vrac gencodé	25
542290	3479045422905	Z.BLANC	120	55,5	22	1,5	Vrac gencodé	25

Soumis à éco-participation Mobilier.

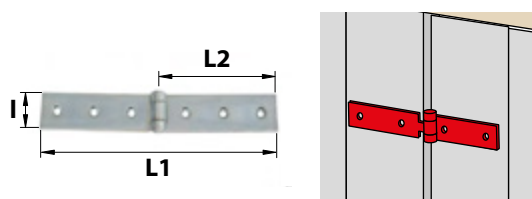

Charnière de caisse bouts droits

Code	Gencod		L1	L2	I	Ep.	Type packaging	
6213607	3221686213677	Z.BLANC	140	70	30	2,5	Vrac gencodé	12
6213609	3221686213691	Z.BLANC	190	95	30	3	Vrac gencodé	12

Soumis à éco-participation Mobilier.

Charnières de caisse & table

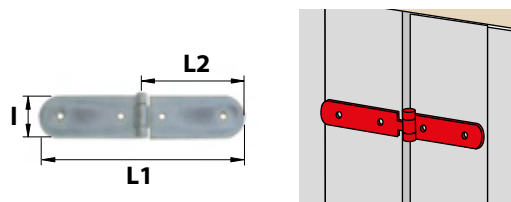

Charnière de caisse bouts ronds

Code	Gencod	Z.BLANC	L1	L2	I	Ep.	Type packaging	
6112595	3221686112598	Z.BLANC	190	95	40	2	Vrac gencodé	12

Soumis à éco-participation Mobilier.

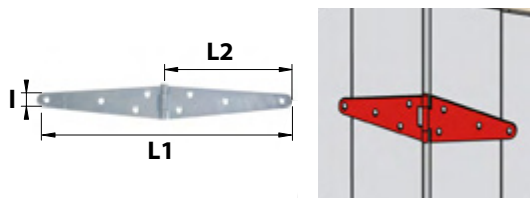

Charnière de caisse triangle

Code	Gencod	Z.BLANC	L1	L2	I	Ep.	Type packaging	
6213030	3221686213301	Z.BLANC	200	100	30	1,75	Vrac gencodé	12
6213038	3221686213387	Z.BLANC	300	150	38	2	Vrac gencodé	12

Soumis à éco-participation Mobilier.

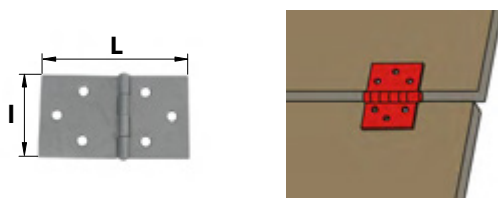

Charnière de table

Code	Gencod	BRUT	L	I	Type packaging	
9001312	3479040013122	BRUT	45	80	Vrac gencodé	10

Soumis à éco-participation Mobilier.

Compas

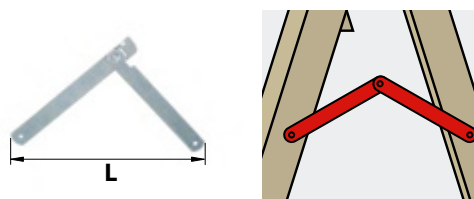

Compas de tréteaux

Code	Gencod	Z.BLANC	L	Type packaging	
Droite					
6214125	3221686214124	Z.BLANC	250	Vrac gencodé	10
Gauche					
6214225	3221686214223	Z.BLANC	250	Vrac gencodé	10

Soumis à éco-participation Mobilier.

Poignées de meuble

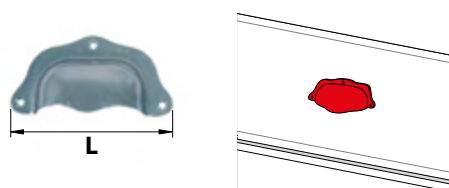

Poignée de meuble coquille

Code	Gencod	Z.BLANC	L	Type packaging	
6123001	3221686123013	Z.BLANC	80	Vrac gencodé	10
6123003	3221686123037	Z.BLANC	100	Vrac gencodé	10

Soumis à éco-participation Mobilier.

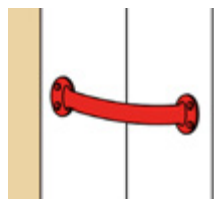
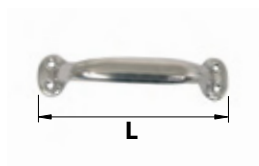

Poignée emboutie

Code	Gencod		L	Type packaging	
3138128	3221683138126	NICKELÉ	128	Vrac gencodé	25
3141140	3221683141140	NICKELÉ	140	Vrac gencodé	25

Poignée fil à pattes

Code	Gencod		D	L1	L2	Type packaging	
9158085	3221689158081		8	140	85	Vrac gencodé	10
0357804	3308183578048		8	165	95	Vrac gencodé	10
0502104	3308185021047		10	160	105	Vrac gencodé	10
7158085	3221687158083	Z.BLANC	8	140	85	Vrac gencodé	10
6158100	3221686158107	Z.BLANC	8	165	95	Vrac gencodé	10
0502102	3308185021023	Z.BLANC	10	160	105	Vrac gencodé	10
0258201	3308182582015		8	165	95		1 boîte 50 pièces
0258202	3308182582022	Z.BLANC	8	165	105		

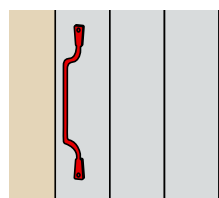
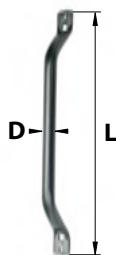
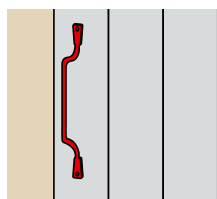
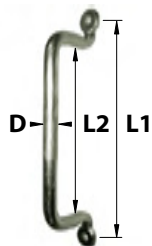

Poignée de tirage droite

Code	Gencod		D	L	Type packaging	
794025	3026727940259	GRANITE	20	280	Vrac gencodé	1
794040	3026727940402	GRANITE	20	400	Vrac gencodé	1

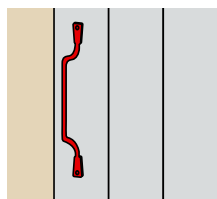
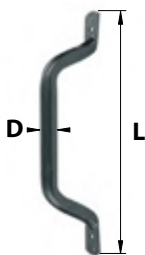

Poignée de tirage renforcée

Code	Gencod		D	L	Type packaging	
794035	3026727940358	GRANITE	25	350	Vrac gencodé	1

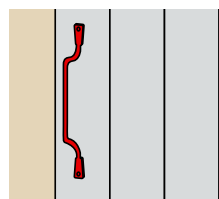
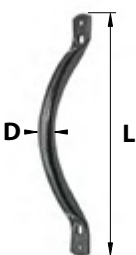

Poignée de tirage demi-ronde

Code	Gencod		D	L	Type packaging	
M795001	3026727950012	GRANITE	20	300	Vrac gencodé	1

Poignées de meuble

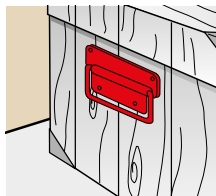
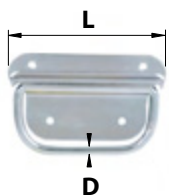
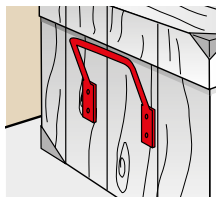
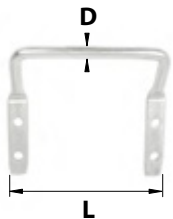
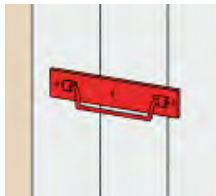
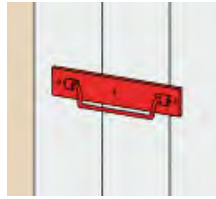
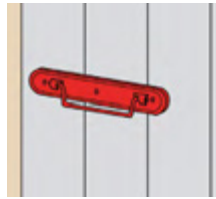

Poignée sur platine bouts ronds

Code	Gencod		L	Type packaging	
6149014	3221686149143	Z.BLANC	140	Vrac gencodé	10
6149016	3221686149167	Z.BLANC	160	Vrac gencodé	10
6149019	3221686149198	Z.BLANC	190	Vrac gencodé	10
8149014	3221688149141		140	Vrac gencodé	10
8149016	3221688149165		160	Vrac gencodé	10
8149019	3221688149196		190	Vrac gencodé	10
0170900	3308181709000	INOX 316 L	140	Vrac gencodé	1

Poignée sur platine bouts carrés

Code	Gencod		L	Type packaging	
8150012	3221688150123		120	Vrac gencodé	10
8150014	3221688150147		140	Vrac gencodé	10
8150016	3221688150161		160	Vrac gencodé	10
8150019	3221688150192		190	Vrac gencodé	10
0491303	3308184913039	Z.BLANC	120	Vrac gencodé	10
0724103	3308187241030	Z.BLANC	140	Vrac gencodé	10
7150016	3221687150162	Z.BLANC	160	Vrac gencodé	10
7150019	3221687150193	Z.BLANC	190	Vrac gencodé	10
0246504	3308182465042		140		1 boîte 30 pièces
0246503	3308182465035	Z.BLANC	140		1 boîte 30 pièces

Poignée sur platine bouts carrés inox

Code	Gencod		L	Type packaging	
795214	3026727952146	INOX 304 L	140	Vrac gencodé	4

Poignée de baquet

Code	Gencod		D	L	Type packaging	
000317	3479040003178	Z.BLANC	10	120	Vrac gencodé	10

Poignée de maille

Code	Gencod		D	L	Type packaging	
6246500	3221686246507	Z.BLANC	8	96	Vrac gencodé	10
6146002	3221686146005	Z.BLANC	8	105	Vrac gencodé	10
6147500	3221686147507	Z.BLANC	8	125	Vrac gencodé	10

Soumis à éco-participation Mobilier.

Coins de malle

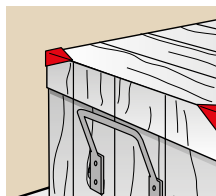
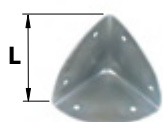

Coin de malle

Code	Gencod		L	Type packaging	
6121035	3221686121354	Z.BLANC	35	Vrac gencodé	25
6121040	3221686121408	Z.BLANC	40	Vrac gencodé	25
6121045	3221686121453	Z.BLANC	45	Vrac gencodé	25
6121060	3221686121606	Z.BLANC	60	Vrac gencodé	25

Soumis à éco-participation Mobilier.

Fermeurs

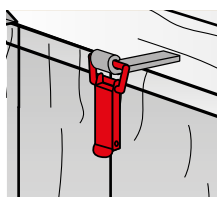
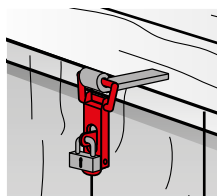
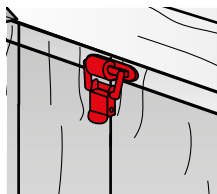
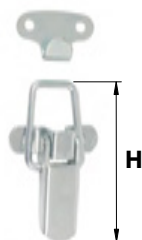

Fermeur à levier + crochet

Code	Gencod		H	Type packaging	
6475060	3221686475068	Z.BLANC	60	Vrac gencodé	10

Soumis à éco-participation Mobilier.

Minifermeur à levier

Code	Gencod		H	Type packaging	
6217060	3221686217064	Z.BLANC	60	Vrac gencodé	10

Soumis à éco-participation Mobilier.

Fermeur à levier

Code	Gencod		H	Type packaging	
6117075	3221686117753	Z.BLANC	75	Vrac gencodé	10

Soumis à éco-participation Mobilier.

Fermeur à levier porte-cadenas

Code	Gencod		H	Type packaging	
6208075	3221686208079	Z.BLANC	75	Vrac gencodé	10

Soumis à éco-participation Mobilier.

Fermeur grand modèle N°15

Code	Gencod		H	Type packaging	
6115105	3221686115100	Z.BLANC	115	Vrac gencodé	10

Soumis à éco-participation Mobilier.

Crochets pour fermail

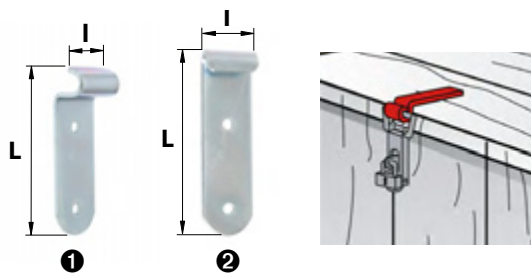

Crochet pour fermail

Code	Gencod		L	l	e	Type packaging	
1 Coudé							
6116070	3221686116077	Z.BLANC	81,5	25	2,5	Vrac gencodé	10
2 Droit							
6216090	3221686216098	Z.BLANC	86,5	25	2,5	Vrac gencodé	10
Grand modèle							
6114080	3221686114080	Z.BLANC	95,5	30	3	Vrac gencodé	10

Soumis à éco-participation Mobilier.

Porte-cadenas

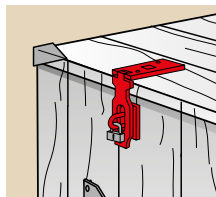
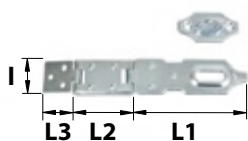

Porte-cadenas à recouvrement + piton

Code	Gencod		L1	L2	L3	l	Ep.	Type packaging	
6141120	3221686141123	Z.BLANC	46	38	38	32	1,2	Vrac gencodé	1
6141140	3221686141147	Z.BLANC	82	36	25	26	1	Vrac gencodé	1

Soumis à éco-participation Mobilier.

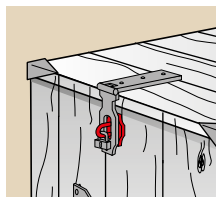
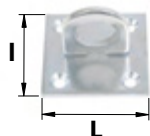

Piton sur platine à visser

Code	Gencod		L	l	Type packaging	
6245030	3221686245036	Z.BLANC	30	30	Vrac gencodé	10
6245040	3221686245043	Z.BLANC	40	40	Vrac gencodé	10

Soumis à éco-participation Mobilier.

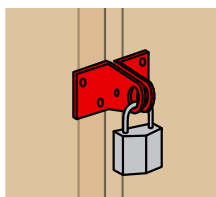
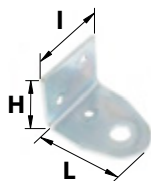

Platine porte-cadenas

Code	Gencod		H	L	l	Ep.	Type packaging	
006917	3479040069174	Z.BLANC	45	36	34	2,5	Vrac gencodé	10

Soumis à éco-participation Mobilier.

Taqet de lit

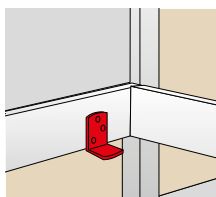
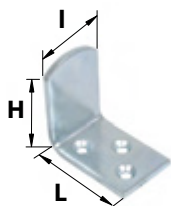

Taqet de lit

Code	Gencod		H	L	l	Ep.	Type packaging	
6220050	3221686220057	Z.BLANC	50	50	35	4	Vrac gencodé	10

Soumis à éco-participation Mobilier.



L'EXTÉRIEUR DE L'HABITAT

LES CONNECTEURS

Equerres nervurées droites

Les équerres nervurées droites peuvent servir à de multiples applications.

Domaines d'utilisation :

Menuiseries intérieures et extérieures

Matière : Acier

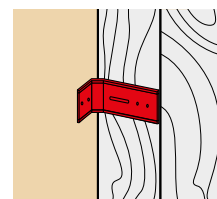

Code	Gencod		L	L2	Ep.	I	Nb de trous	Ø de trous	Type packaging	
627200	3221686272001	GALVA.	45	50	1,5	30	-	5,5	Vrac gencodé	25
627205	3221686272056	GALVA.	50	65	1,5	30	-	5,5	Vrac gencodé	25
627210	3221686272100	GALVA.	65	65	1,5	30	1	5,5	Vrac gencodé	25
627215	3221686272155	GALVA.	80	65	1,5	30	2	5,5	Vrac gencodé	25
627220	3221686272209	GALVA.	95	65	1,5	30	3	5,5	Vrac gencodé	25
C627225	3221686272254	GALVA.	110	65	1,5	30	4	5,5	Vrac gencodé	25
C627230	3221686272308	GALVA.	125	65	1,5	30	5	5,5	Vrac gencodé	25
627235	3221686272353	GALVA.	140	65	1,5	30	6	5,5	Vrac gencodé	25

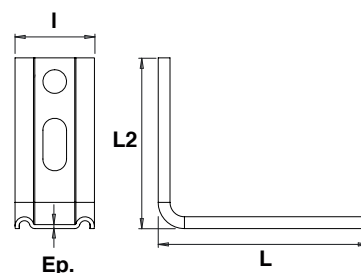

Equerres nervurées 3 pans coupés angle 45°

Les équerres nervurées pans coupés sont étudiées pour fixer les dormants des menuiseries.

Domaines d'utilisation :

Menuiseries intérieures et extérieures

Matière : Acier

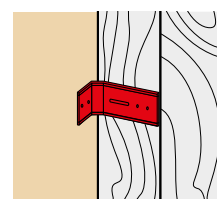

Code	Gencod		L	L2	Ep.	I	Nb de trous	Ø de trous	Type packaging	
9925015	3330760024464	GALVA.	55	50	1,5	30	-	5,5	Vrac gencodé	25
0109603	3308181096032	GALVA.	55	70	1,5	30	-	5,5	Vrac gencodé	25
0109703	3308181097039	GALVA.	70	70	1,5	30	1	5,5	Vrac gencodé	25
627160	3221686271608	GALVA.	85	70	1,5	30	2	5,5	Vrac gencodé	25
0109803	3308181098036	GALVA.	100	70	1,5	30	3	5,5	Vrac gencodé	25
627170	3221686271707	GALVA.	115	70	1,5	30	4	5,5	Vrac gencodé	25
0109903	3308181099033	GALVA.	130	70	1,5	30	5	5,5	Vrac gencodé	25
0110003	3308181100036	GALVA.	160	70	1,5	30	7	5,5	Vrac gencodé	25
0942200	3308189422000	GALVA.	55	50	1,5	30	-	5,5		50
0439503	3308184395033	GALVA.	55	70	1,5	30	-	5,5		100
0256800	3308182568002	GALVA.	70	70	1,5	30	1	5,5		100
0256700	3308182567005	GALVA.	100	70	1,5	30	3	5,5		50
0439603	3308184396030	GALVA.	130	70	1,5	30	5	5,5		50
0257200	3308182572009	GALVA.	160	70	1,5	30	7	5,5		30

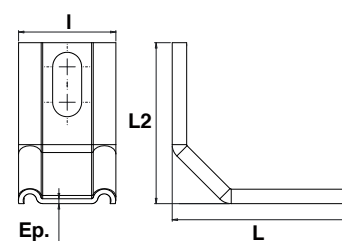

Équerres tronquées renforcées angle 45°

Les équerres tronquées renforcées sont étudiées pour fixer les dormants des menuiseries extérieures.

Domaines d'utilisation :

Menuiseries intérieures et extérieures

Matière : Acier

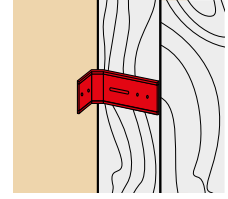

Code	Gencod		L	L2	Ep.	I	Nb de trous	Ø de trous	Nb de trous	Ø de trous	Type packaging	
6176004	3221686176040	GALVA.	40	70	2	35	6	5,5	1	8,5	Vrac gencodé	20
6176005	3221686176057	GALVA.	50	70	2	35	6	5,5	2	8,5	Vrac gencodé	20
C176007	3221686176071	GALVA.	70	70	2	35	8	5,5	3	8,5	Vrac gencodé	20
6176008	3221686176088	GALVA.	80	70	2	35	10	5,5	3	8,5	Vrac gencodé	20
C176010	3221686176101	GALVA.	100	70	2	35	10	5,5	3	8,5	Vrac gencodé	20
6176012	3221686176125	GALVA.	120	70	2	35	10	5,5	3	8,5	Vrac gencodé	20
C176014	3221686176149	GALVA.	140	70	2	35	10	5,5	4	8,5	Vrac gencodé	20

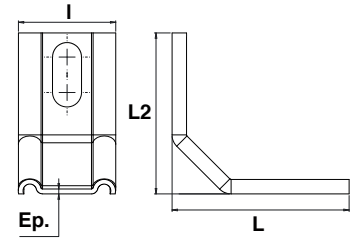

Plaques de liaison

Les plaques de liaison servent à de multiples liaisons et applications.

Domaines d'utilisation :

Liaison poteau/poutre, réparations

Matière : Acier

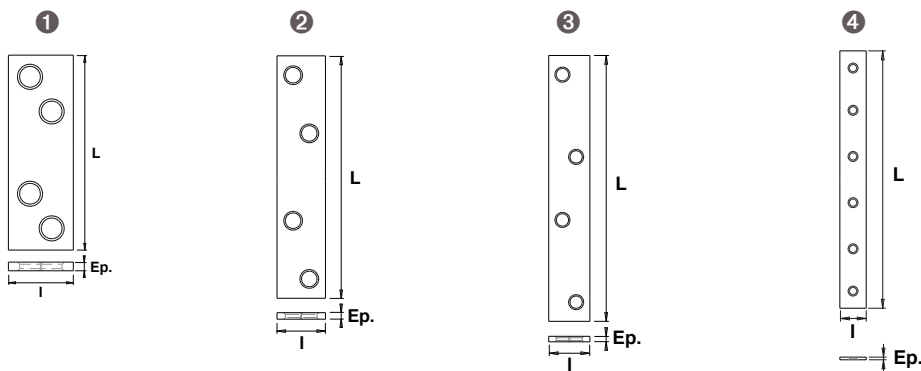
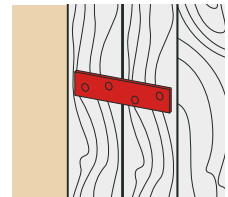

	Code	Gencod		L	I	Ep.	Nb de trous	Ø de trous	Type packaging	
①	C641100	3221686411004	ZINC GALVA Z275	45	15	2	4	4,8	Vrac gencodé	25
②	C641102	3221686411028	ZINC GALVA Z275	75	15	2	4	4,8	Vrac gencodé	25
③	C641104	3221686411042	ZINC GALVA Z275	97	15	2	4	4,5	Vrac gencodé	25
④	641110	3221686411103	ZINC GALVA Z275	195	20	2	6	5,5	Vrac gencodé	25

Pattes d'assemblage fortes

Les plaques d'assemblage fortes servent à de multiples liaisons et applications.

Domaines d'utilisation :

Liaison poteau/poutre, réparations

Matière : Acier

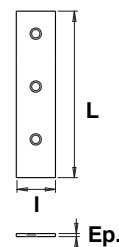
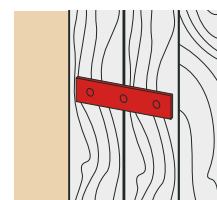

Code	Gencod		L	I	Ep.	Nb de trous	Ø de trous	Type packaging	
6175200	3221686175203	ZBLANC	200	30	3	3	6	Vrac gencodé	10
6175300	3221686175302	ZBLANC	300	30	3	3	6	Vrac gencodé	10
6175400	3221686175401	ZBLANC	400	30	3	3	6	Vrac gencodé	10

Plaques perforées

Les plaques perforées sont idéales pour l'assemblage de poutre bois. Peuvent être pliées sur chantier.

Domaines d'utilisation :

Liaison poteau/poutre, réparations, aboutage

Matière : Acier

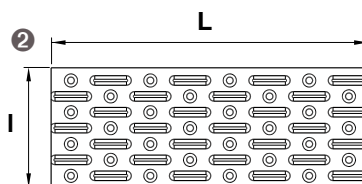
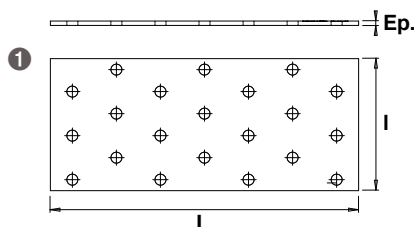

Code	Gencod		L	I	Ep.	Nb de trous	Ø de trous	Charge en [kN]	ETA	Type packaging	
3440101	5907708144010	ZINC GALVA Z275	80	40	2	8	5	3,47	CE	Vrac gencodé	20
3440201	5907708144027	ZINC GALVA Z275	100	40	2	10	5	3,51	CE	Vrac gencodé	20
C440301	5907708144034	ZINC GALVA Z275	120	40	2	12	5	3,42	CE	Vrac gencodé	20
C440401	5907708144041	ZINC GALVA Z275	160	40	2	16	5	3,48	CE	Vrac gencodé	20
C440501	5907708144058	ZINC GALVA Z275	140	60	2	21	5	3,54	CE	Vrac gencodé	20
C440601	5907708144065	ZINC GALVA Z275	160	60	2	24	5	3,7	CE	Vrac gencodé	20
C440701	5907708144072	ZINC GALVA Z275	200	60	2	30	5	3,75	CE	Vrac gencodé	20
C440801	5907708144089	ZINC GALVA Z275	240	60	2	36	5	4,39	CE	Vrac gencodé	20
C440901	5907708144096	ZINC GALVA Z275	200	80	2	40	5	5,03	CE	Vrac gencodé	20
C441001	5907708144102	ZINC GALVA Z275	240	80	2	48	5	4,32	CE	Vrac gencodé	20
C441101	5907708144119	ZINC GALVA Z275	300	80	2	60	5	4,94	CE	Vrac gencodé	10
C441201	5907708144126	ZINC GALVA Z275	200	100	2	50	5	4,32	CE	Vrac gencodé	20
C441301	5907708144133	ZINC GALVA Z275	240	100	2	60	5	4,94	CE	Vrac gencodé	10
C641075	3221686410755	ZINC GALVA Z275	75	50	1	7	4,3	-	-	Vrac gencodé	20
6410261	3221686410267	ZINC GALVA Z275	106	50	1,3	10	4,3	-	-	Vrac gencodé	25
6410260	3221686412605	ZINC GALVA Z275	200	75	1	28	4,3	-	-	Vrac gencodé	25

Platines

Les platines permettent des assemblages multiples grâce à leurs nombreux trous.



Domaines d'utilisation :

Liaison poutres bois

Matière : Acier



1

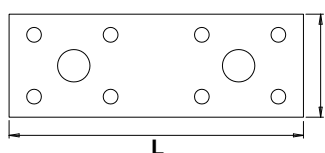
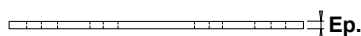

2

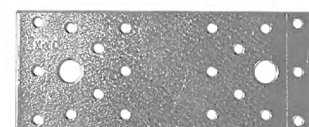
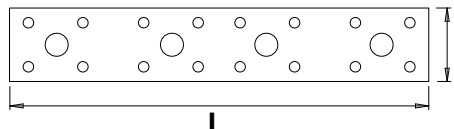

3

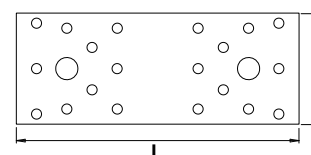

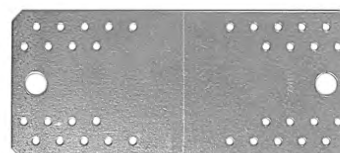
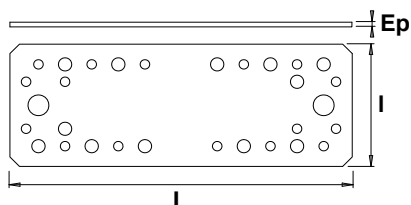

4

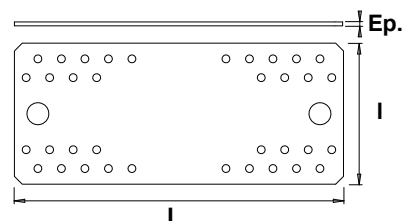

5



	Code	Gencod		L	I	Ep.	Nb de trous Ø de	Nb de trous Ø de	Nb de trous Ø de	Charge en [kN]	ETA	Type packaging 			
1	C444101	5907708144416	ZINC GALVA Z275	100	35	2,5	8	5	2	11	3,51	CE	Vrac gencodé 20		
2	C444301	5907708144430	ZINC GALVA Z275	200	35	2,5	16	5	4	11	3,60	CE	Vrac gencodé 20		
3	C444201	5907708144423	ZINC GALVA Z275	140	55	2,5	20	5	2	11	3,7	CE	Vrac gencodé 20		
4	C444501	5907708144454	ZINC GALVA Z275	180	65	2,5	8	5	2	11	12	7	3,67	CE	Vrac gencodé 20
5	C444601	5907708144461	ZINC GALVA Z275	210	90	2,5	36	5	2	14	3,51	CE	Vrac gencodé 20		

Plaques de réparation

Les plaques de réparation servent dans de multiples applications, notamment pour l'aboutage de poutres ou la réparation de bois fendus ou fissurés.

Domaines d'utilisation :

Renforcement de bois fendus ou fissurés, aboutage de deux éléments.

Matière : Acier

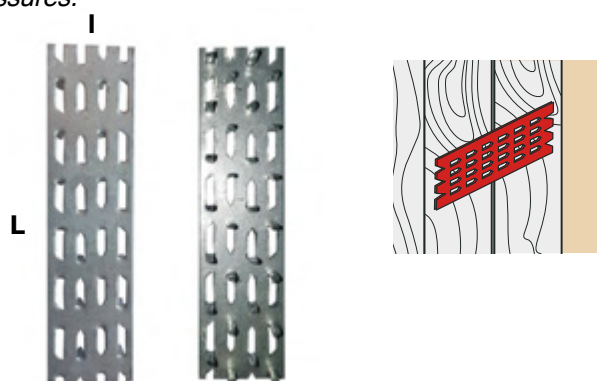

Code	Gencod		L	I	Ep.	Type packaging	
6410280	3221686410809	Z.BLANC	99	25	1	Vrac gencodé	25
C641081	3221686410816	Z.BLANC	129	25	1	Vrac gencodé	25
6410279	3221686410793	Z.BLANC	129	76	1	Vrac gencodé	25

Bandes perforées

Pour l'assemblage, la suspenso et la connexion des éléments de construction et autres.

Domaines d'utilisation :

Antiflambement de charpente, fixation de gaines, ...

Matière : Acier

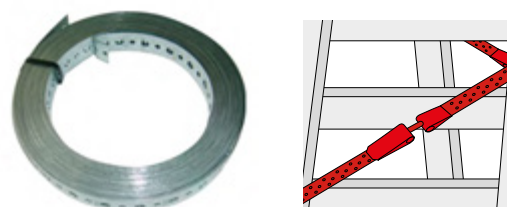

Code	Gencod		L	I	Ep.	Ø de trous	Ø de trous	Type packaging	
0944200	3308189442008	ZINC GALVA Z275	3000	20	0,9	6	4	Vrac gencodé	1
C443511	5907708144355	ZINC GALVA Z275	10000	20	0,9	6	4	Vrac gencodé	1

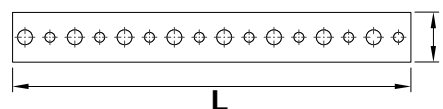

Equerres de poutre

Equerres de renfort pour solives.

Domaines d'utilisation :

Liaison poutres bois.

Matière : Acier

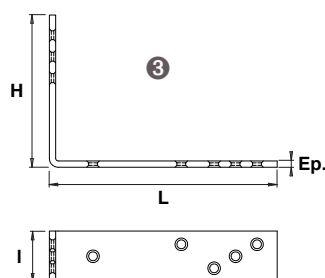
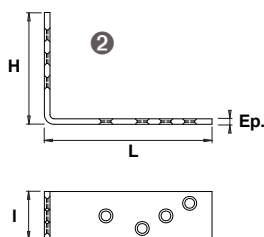
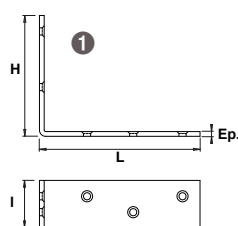
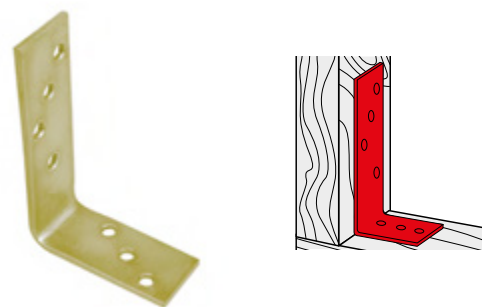

	Code	Gencod		L	I	H	Ep.	Nb de trous	Ø de trous en [kN]	Charge	ETA	Type packaging	
①	3401501	5907708140159	ZINC GALVA JAUNE	100	30	75	3	5	4,5	7,46	ETA-13/0124 + CE	Vrac gencodé	20
②	3401601	5907708140166	ZINC GALVA JAUNE	120	35	80	4	7	7	8,62	ETA-13/0124 + CE	Vrac gencodé	20
③	3401701	5907708140173	ZINC GALVA JAUNE	180	40	120	5	8	7	8,62	ETA-13/0124 + CE	Vrac gencodé	10

Équerres de chéneaux



Les équerres servent à maintenir les chéneaux.

Domaines d'utilisation :

Chéneaux

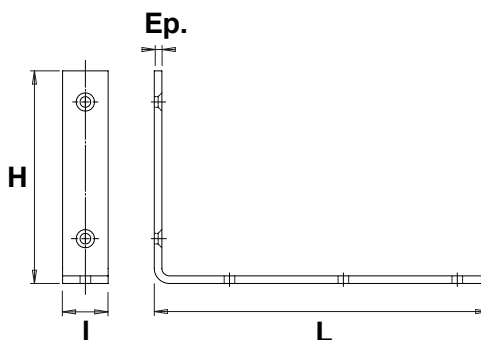
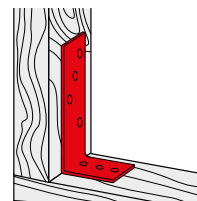
Matière : Acier



Code	Gencod		L	I	H	Ep.	Nb de trous	Ø de trous	Type packaging	
7167160	3221687167160	Z.BLANC	160	30	140	5	5	7	Vrac gencodé	25
7167220	3221687167221	Z.BLANC	220	30	140	5	5	7	Vrac gencodé	25
7167300	3221687167306	Z.BLANC	300	30	140	5	5	7	Vrac gencodé	25

Tirants de sablière

Pièce de charpente travaillant à la traction.

Domaines d'utilisation :

Charpentes bois

Matière : Acier

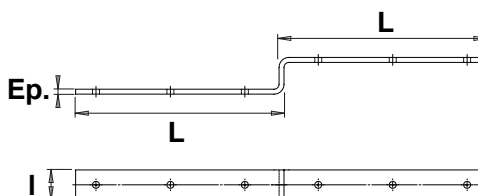
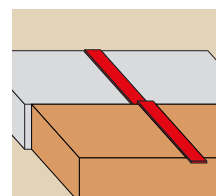

Code	Gencod		L	I	Ep.	Nb de trous	Ø de trous	Type packaging	
7167000	3221687167009	Z.BLANC	210	30	5	6	7,4	Vrac gencodé	10

Equerres d'assemblage simples

Pour l'assemblage simple de travaux de menuiserie.

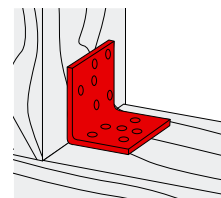

Domaines d'utilisation :

Montants de bardage, lisses de bardage, consoles, épars, aisseliers, ...

Matière : Acier

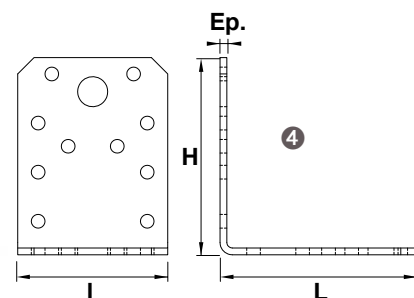
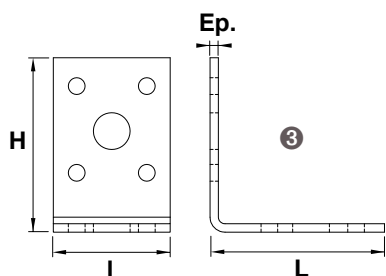
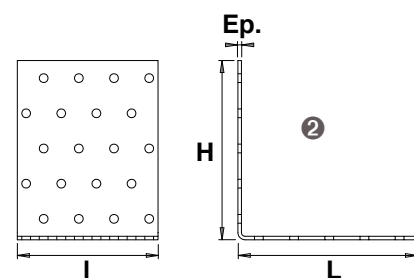
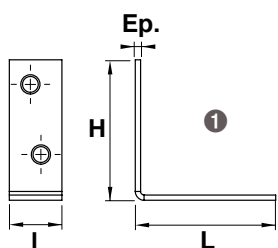

	Code	Gencod		I	L	H	Ep.	Nb de trous	Ø de trous	Nb de trous	Ø de trous	Nb de trous	Ø de trous	Charge en [kN]	ETA	Type packaging	
1	C400241	5907708140586	ZINC GALVA JAUNE	15	40	40	1,5	4	4,5	-	-	-	-	2,51	CE	Vrac gencodé	50
	C410101	5907708141019	ZINC GALVA Z275	40	40	40	2	8	5	-	-	-	-	3,81	ETA-11/0140 + CE	Vrac gencodé	50
	C410102	3221684101020	ZINC GALVA Z275	40	50	50	2	-	-	-	-	-	-	-	-	Vrac gencodé	50
	C410301	5907708141033	ZINC GALVA Z275	40	60	60	2	12	5	-	-	-	-	3,83	ETA-11/0140 + CE	Vrac gencodé	20
	C410201	5907708141026	ZINC GALVA Z275	60	40	40	2	12	5	-	-	-	-	3,81	ETA-11/0140 + CE	Vrac gencodé	20
	3411401	5907708141149	ZINC GALVA Z275	100	40	40	2	20	5	-	-	-	-	5,65	ETA-11/0140 + CE	Vrac gencodé	20
	C410701	5907708141071	ZINC GALVA Z275	40	80	80	2	16	5	-	-	-	-	5,79	ETA-11/0140 + CE	Vrac gencodé	20
2	C410401	5907708141040	ZINC GALVA Z275	60	60	60	2	18	5	-	-	-	-	5,79	ETA-11/0140 + CE	Vrac gencodé	20
	C410801	5907708141088	ZINC GALVA Z275	60	80	80	2	24	5	-	-	-	-	6,68	ETA-11/0140 + CE	Vrac gencodé	20
	C411101	5907708141118	ZINC GALVA Z275	60	100	100	2	30	5	-	-	-	-	6,99	ETA-11/0140 + CE	Vrac gencodé	20
	C410501	5907708141057	ZINC GALVA Z275	80	60	60	2	24	5	-	-	-	-	6,86	ETA-11/0140 + CE	Vrac gencodé	20
	C410901	5907708141095	ZINC GALVA Z275	80	80	80	2	32	5	-	-	-	-	8,64	ETA-11/0140 + CE	Vrac gencodé	20
	C411201	5907708141125	ZINC GALVA Z275	80	100	100	2	40	5	-	-	-	-	13,01	ETA-11/0140 + CE	Vrac gencodé	20
	C410601	5907708141064	ZINC GALVA Z275	100	60	60	2	30	5	-	-	-	-	7,72	ETA-11/0140 + CE	Vrac gencodé	20
	C411001	5907708141101	ZINC GALVA Z275	100	80	80	2	40	5	-	-	-	-	10,91	ETA-11/0140 + CE	Vrac gencodé	20
3	C403101	5907708140319	ZINC GALVA Z275	35	50	50	2,5	8	5	2	11	-	-	6,85	ETA-07/0277 + CE	Vrac gencodé	20
	C403201	5907708140326	ZINC GALVA Z275	55	70	70	2,5	20	5	2	11	-	-	10,95	ETA-07/0277 + CE	Vrac gencodé	20
4	C403401	5907708140340	ZINC GALVA Z275	65	90	90	2,5	16	5	2	11	12	7	17,8	ETA-07/0277 + CE	Vrac gencodé	20
	C403501	5907708140357	ZINC GALVA Z275	90	105	105	2,5	36	5	2	14	-	-	21,9	ETA-07/0277 + CE	Vrac gencodé	20

Equerres d'assemblage réglables



Pour l'assemblage simple de travaux de menuiserie.

Domaines d'utilisation :

Montants de bardage, lisses de bardage, consoles, épars, aisseliers, ...

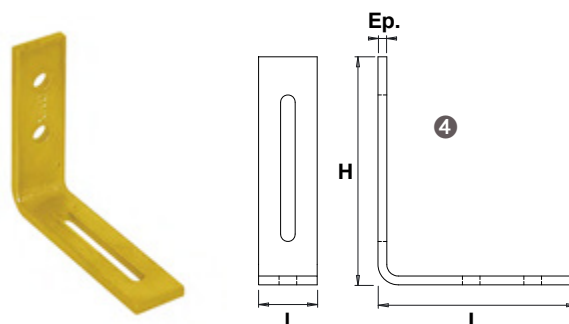
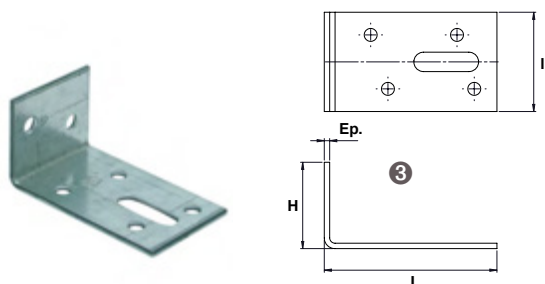
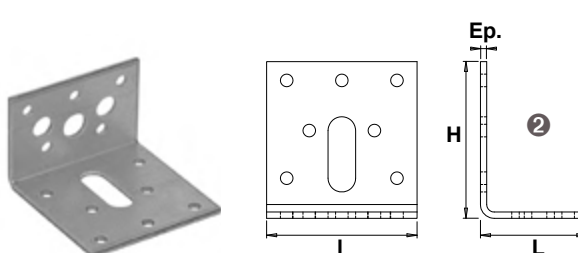
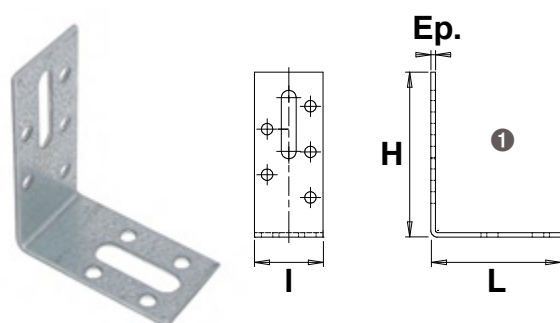
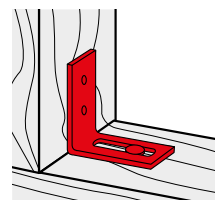
Matière : Acier



	Code	Gencod		L	I	H	Ep.	Nb de trous	Ø de trous	Nb de trous	Ø de trous	Charge en [kN]	ETA	Type packaging	
①	C421601	5907708142160	ZINC GALVA Z275	70	30	55	2	9	5	-	-	6,68	ETA-13/0124 + CE	Vrac gencodé	20
	C421701	5907708142177	ZINC GALVA Z275	80	30	55	2	10	5	-	-	6,75	ETA-13/0124 + CE	Vrac gencodé	20
②	C421201	5907708142122	ZINC GALVA Z275	60	60	40	2,5	11	5	2	9	6,7	ETA-14/0425 + CE	Vrac gencodé	20
③	6125408	3221686125482	ZINC GALVA Z275	80	46	40	2,5	6	6	-	-	3,5	-	Vrac gencodé	20
④	3421101	5907708142115	ZINC GALVA JAUNE	75	20	65	3	2	6	-	-	5,1	ETA-14/0425 + CE	Vrac gencodé	20

Equerres d'assemblage réglables

Pour des connexions des petites ossatures de menuiserie intérieures ou extérieures.

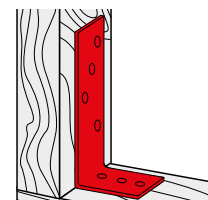

Domaines d'utilisation :

Petites ossatures, aménagements intérieurs

Matière : Acier

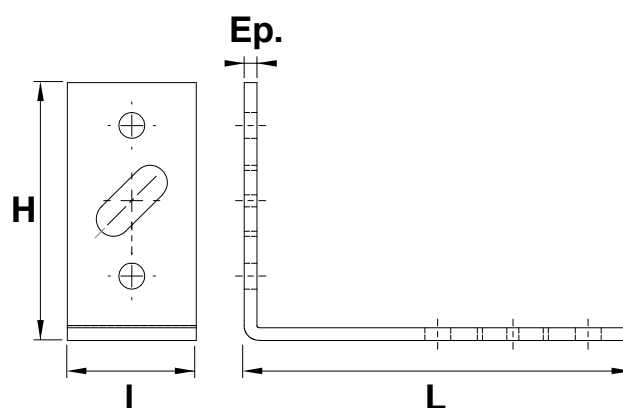

Code	Gencod		L	I	H	Ep.	Nb de trous	Ø de trous	Type packaging	
7175070	3221687175073	Z.BLANC	70	30	60	3	4	6	Vrac gencodé	25
7175090	3221687175097	Z.BLANC	90	30	60	3	4	6	Vrac gencodé	25
7175120	3221687175127	Z.BLANC	120	30	60	3	4	6	Vrac gencodé	25
7175130	3221687175134	Z.BLANC	130	30	90	3	4	6	Vrac gencodé	25
6173040	3221686173049	Z.BLANC	40	35	70	3	3	5,2	Vrac gencodé	25
6173050	3221686173056	Z.BLANC	50	35	70	3	3	5,2	Vrac gencodé	25
6173070	3221686173070	Z.BLANC	70	35	70	3	4	5,2	Vrac gencodé	25
6173080	3221686173087	Z.BLANC	80	35	70	3	5	5,2	Vrac gencodé	25
6173100	3221686173100	Z.BLANC	100	35	70	3	6	5,2	Vrac gencodé	25
6173120	3221686173124	Z.BLANC	120	35	70	3	7	5,2	Vrac gencodé	25
6173140	3221686173148	Z.BLANC	140	35	70	3	9	5,2	Vrac gencodé	25
6173160	3221686173162	Z.BLANC	160	35	70	3	9	5,2	Vrac gencodé	25
6173170	3221686173179	Z.BLANC	170	35	70	3	9	5,2	Vrac gencodé	25

Equerres d'assemblage renforcées



Pour des applications structurales dans la charpente et la maison à ossature bois.

Domaines d'utilisation :

Fermettes, ancrages de chevrons, ...

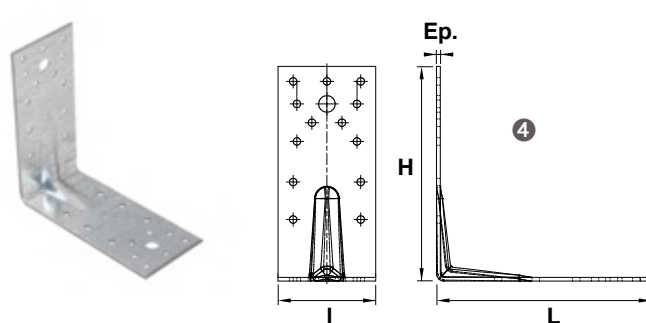
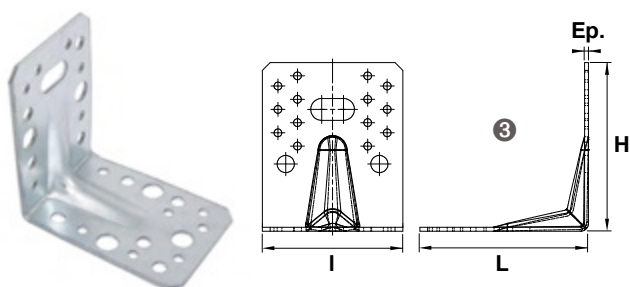
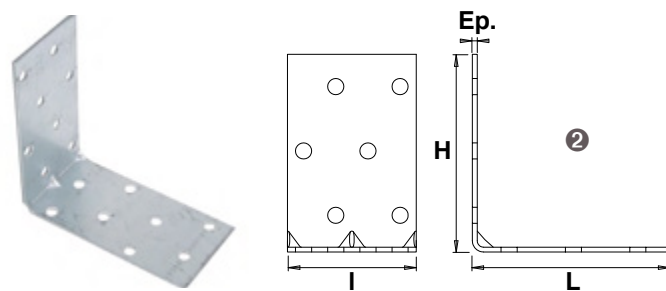
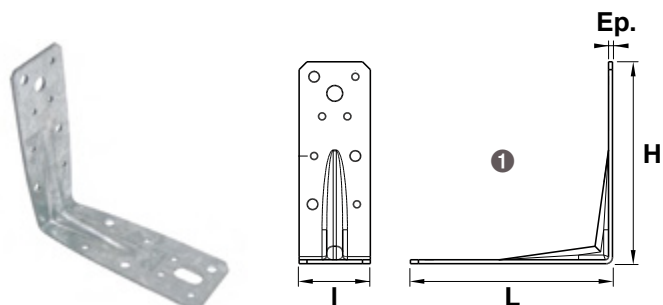
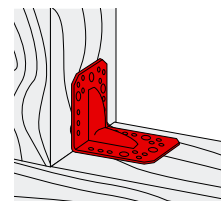
Matière : Acier



	Code	Gencod		L	I	H	Ep.	Nb de trous	Ø de trous	Nb de trous	Ø de trous	Nb de trous	Ø de trous	Charge en [kN]	ETA	Type packaging	
①	C413401	5907708142771	ZINC GALVA Z275	60	40	60	1,5	12	5	-	-	-	-	3,41	ETA-13/0124 + CE	Vrac gencodé	20
②	C413701	5907708142863	ZINC GALVA Z275	80	40	80	1,5	16	5	-	-	-	-	5,53	ETA-13/0124 + CE	Vrac gencodé	20
②	3413802	3221684138026	ZINC GALVA Z275	125	45	125	2,5	10	4,5	6	6,7	1	10	5,11	ETA-09/0205 + CE	Vrac gencodé	20
③	C402301	5907708140234	ZINC GALVA Z275	90	55	50	2,5	20	5	2	11	-	-	14,35	ETA-07/0277 + CE	Vrac gencodé	20
③	C402401	5907708140241	ZINC GALVA Z275	70	55	70	2,5	20	5	2	11	-	-	10,45	ETA-07/0277 + CE	Vrac gencodé	20
③	C402101	5907708140210	ZINC GALVA Z275	90	65	90	2,5	16	5	12	7	2	11	17,8	ETA-07/0277 + CE	Vrac gencodé	20
③	C402201	5907708140227	ZINC GALVA Z275	105	90	105	2,5	36	5	2	14	-	-	21,9	ETA-07/0277 + CE	Vrac gencodé	20
④	C405101	5907708142955	ZINC GALVA Z275	140	65	140	2,5	26	5	2	11	-	-	10,92	ETA-07/0277 + CE	Vrac gencodé	10

Equerres d'assemblage renforcées réglables

Pour des applications structurales dans la charpente et la maison à ossature bois.

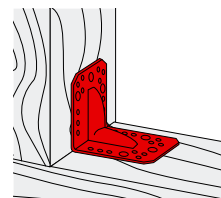



Domaines d'utilisation :

Fermettes, lisses, consoles, ancrages de chevrons, ...

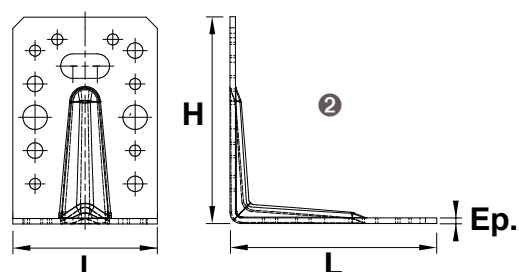
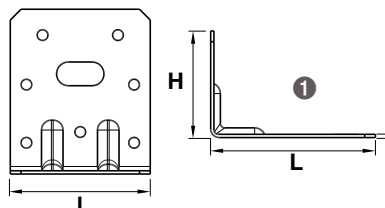
Matière : Acier



	Code	Gencod		L	I	H	Ep.	Nb de trous	Ø de trous	Nb de trous	Ø de trous	Nb de trous	Ø de trous	Charge en [kN]	ETA	Type packaging	
①	3405402	3221684054029	ZINC GALVA Z275	80	60	60	2	13	5	-	-	-	-	-	ETA-09/0205 + CE	Vrac gencodé	20
①	3402502	3221684025029	ZINC GALVA Z275	75	65	48	1,5	13	5	1	11	-	-	-	ETA-09/0205 + CE	Vrac gencodé	20
②	3405501	5907708144485	ZINC GALVA Z275	90	65	90	2,5	13	5	9	7	5	11	3,62	ETA-13/0124 + CE	Vrac gencodé	20
②	3405601	5907708142658	ZINC GALVA Z275	105	90	105	2,5	28	5	4	11	1	14	3,64	ETA-13/0124 + CE	Vrac gencodé	20
②	3405301	5907708142986	ZINC GALVA Z275	172	90	105	3	42	5	7	11	2	14	21,89	ETA-11/0140 + CE	Vrac gencodé	20

Equerres renvoyées

Spécialement conçue pour assembler les chevrons. Son avantage principal consiste à assurer une meilleure résistance du toit au coup de vent.

Domaines d'utilisation :

Chevrons

Matière : Acier

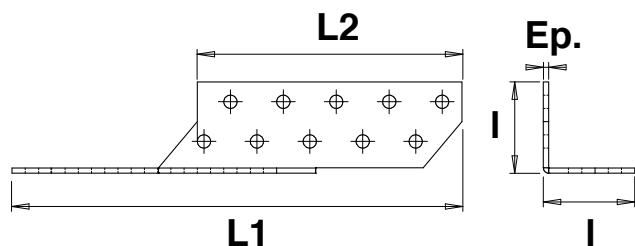
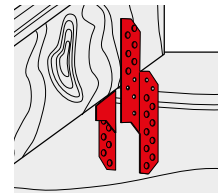

Modèle gauche

Modèle droite

Code	Gencod		Sens	L1	L2	I	Ep.	Nb de trous	Ø de trous	Charge en [kN]	ETA	Type packaging	
C466101	5907708146618	ZINC GALVA Z275	GAUCHE	170	100	40	2	20	5	19,36	ETA-11/0140 + CE	Vrac gencodé	20
C466301	5907708146632	ZINC GALVA Z275		210	140	30	2	28	5	19,25	ETA-11/0140 + CE	Vrac gencodé	20
C466201	5907708146625	ZINC GALVA Z275	DROITE	170	100	40	2	20	5	19,36	ETA-11/0140 + CE	Vrac gencodé	20
C466401	5907708146649	ZINC GALVA Z275		210	140	30	2	28	5	19,25	ETA-11/0140 + CE	Vrac gencodé	20

Equerres d'ancrage

Destinée à l'ancrage du bois dans le béton. Utilisée pour les poutres de fondation, de la sablière, de poteaux. La partie inférieure est immergée dans le béton et la partie en saillie est fixée sur les poutres en bois.

Domaines d'utilisation :

Sablières, poutres de support et ancrage de poteaux.

Matière : Acier

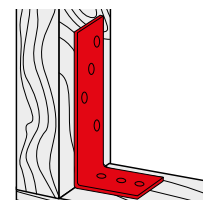

Code	Gencod		L	I	H	Ep.	Nb de trous	Ø de trous	Charge en [kN]	ETA	Type packaging	
C412101	5907708141217	ZINC GALVA Z275	200	40	40	2	24	5	8,9	ETA-11/0140 + CE	Vrac gencodé	20
C412201	5907708141224	ZINC GALVA Z275	300	40	40	2	34	5	11,52	ETA-11/0140 + CE	Vrac gencodé	20

Equerres 135°

Pour l'assemblage de bois sous angle 135°.

Domaines d'utilisation :

Épars, aisseliers et renforcements diagonaux des composants du cadre.

Matière : Acier

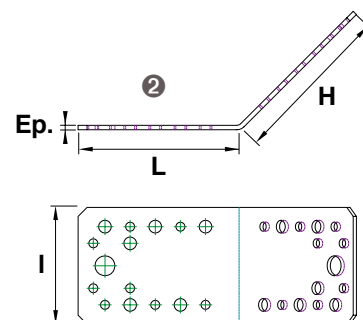
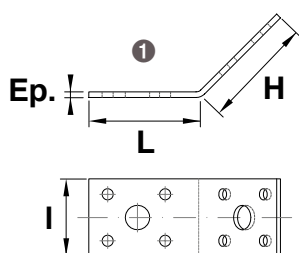
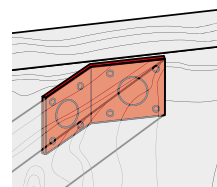

	Code	Gencod		L	I	H	Ep.	Nb de trous	Ø de trous	Nb de trous	Ø de trous	Nb de trous	Ø de trous	Charge en [kN]	ETA	Type packaging	
①	C403135	5907708115058	ZINC GALVA Z275	50	35	50	2,5	8	5	2	11			4,2	ETA-14/0425 + CE	Vrac gencodé	20
②	C403435	5907708115287	ZINC GALVA Z275	90	65	90	2,5	16	5	12	7	2	11	8,3	ETA-14/0425 + CE	Vrac gencodé	20

Equerres de charpente

Cornière spécialement conçue pour assembler les bois obliques tels que les aisseliers et les épars sous un angle non standard.

Domaines d'utilisation :

Épars, aisseliers

Matière : Acier

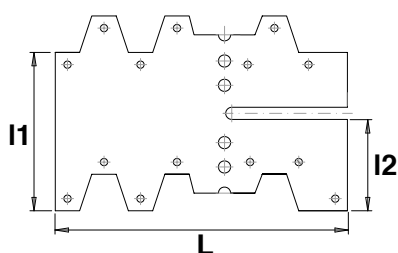
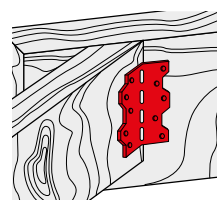

	Code	Gencod		L	I1	I2	Ep.	Nb de trous	Ø de trous	Nb de trous	Ø de trous	Nb de trous	Ø de trous	Charge en [kN]	ETA	Type packaging	
	C462001	5907708146205	ZINC GALVA Z275	120	76	37,5	1,5	14	3	4	5	3,44	ETA-13/0124 + CE	Vrac gencodé	20		

Tés

Utilisé pour le renforcement de liaisons poutre/poteau, châssis de fenêtres ou de portes.

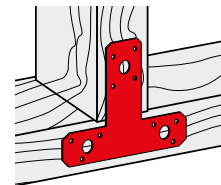

Domaines d'utilisation :

Petites menuiseries, charpente, consoles, ...

Matière : Acier

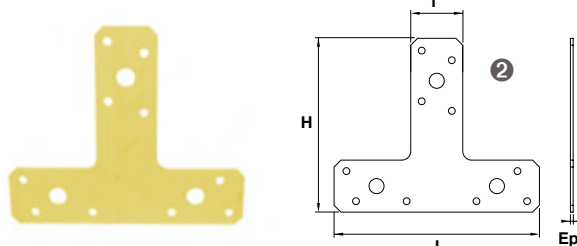
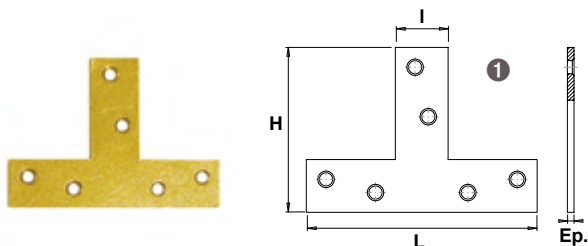

	Code	Gencod		L	I	H	Ep.	Nb de trous	Ø de trous	Nb de trous	Ø de trous	Charge en [kN]	ETA	Type packaging	
1	C462601	5907708146267	ZINC GALVA JAUNE	70	16	50	2	6	4	-	-	3,35	CE	Vrac gencodé	20
2	3462701	5907708146274	ZINC GALVA JAUNE	150	38	127	2	3	11	10	5	3,35	CE	Vrac gencodé	20

Equerres de cadre

Pour l'assemblage de petites menuiseries.

Domaines d'utilisation :

Petites menuiseries

Matière : Acier

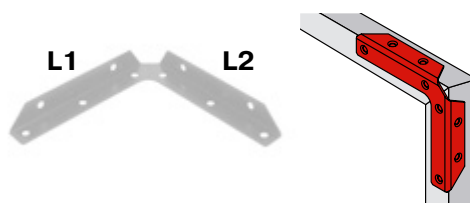

Code	Gencod		L1	L2	Ep.	Nb de trous	Ø de trous	Nb de trous	Ø de trous	Type packaging	
677812	3026726778129	Z.BLANC	120	120	2	2	2,5	4	6	Vrac gencodé	10
677816	3026726778167	Z.BLANC	160	160	2	4	2,5	4	6	Vrac gencodé	10
677820	3026726778204	Z.BLANC	200	200	2	4	2,5	6	6	Vrac gencodé	10
0901001	3308189010016		120	120	2	2	2,5	4	6	Vrac gencodé	10
0903001	3308189030014		160	160	2	4	2,5	4	6	Vrac gencodé	10
0903101	3308189031011		200	200	2	4	2,5	6	6	Vrac gencodé	10

Mini sabots

Suspente de poutre pour construction légère.

Domaines d'utilisation :

Faux-plafonds, plancher, terrasse, solivette...

Matière : Acier

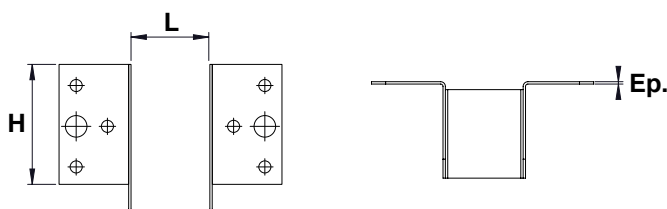
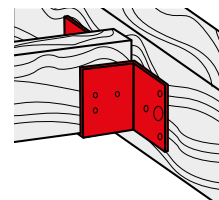

Code	Gencod	ZINC GALVA Z275	L	I	H	Ep.	Nb de trous	Ø de trous	Nb de trous	Ø de trous	Charge en [kN]	ETA	Type packaging	
6127032	3221686127325	ZINC GALVA Z275	33	36	73	1	10	4	2	7	-	-	Vrac gencodé	10
3454601	5907708145468	ZINC GALVA Z275	38	45	71	1	12	5	2	11	14,29	ETA-13/0124 + CE	Vrac gencodé	10
3454701	5907708145475	ZINC GALVA Z275	41	45	70	1	12	5	2	11	14,29	ETA-13/0124 + CE	Vrac gencodé	10
3454801	5907708145482	ZINC GALVA Z275	51	45	65	1	12	5	2	11	14,29	ETA-13/0124 + CE	Vrac gencodé	10
3454901	5907708145499	ZINC GALVA Z275	60	45	60	1	12	5	2	11	14,29	ETA-13/0124 + CE	Vrac gencodé	10

Sabots poutre ailes intérieures

Sabot de poutre idéal pour les espaces réduits.

Domaines d'utilisation :

Permet la fixation de solives, pannes, poteau poutres, lisses, ...

Matière : Acier

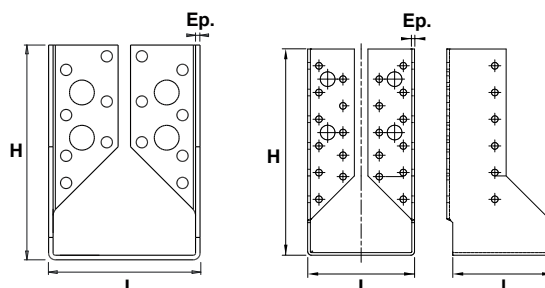
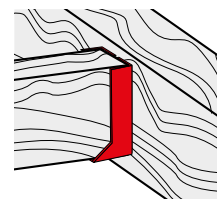

Code	Gencod	ZINC GALVA Z275	L	I	H	Ep.	Nb de trous	Ø de trous	Nb de trous	Ø de trous	Nb de trous	Ø de trous	Charge en [kN]	ETA	Type packaging	
3456502	3221684565020	ZINC GALVA Z275	63	75	118	2	20	5	4	11	1	7	25,26	ETA-09/0205 + CE	Vrac gencodé	10
3456401	5907708145642	ZINC GALVA Z275	76	75	152	2	34	5	4	11	-	-	23,65	ETA-07/0277 + CE	Vrac gencodé	10
C456601	5907708145666	ZINC GALVA Z275	80	75	120	2	28	5	4	11	-	-	17,15	ETA-07/0277 + CE	Vrac gencodé	10
C456302	3221684563026	ZINC GALVA Z275	93	75	63	2	20	5	4	11	1	7	14,31	ETA-09/0205 + CE	Vrac gencodé	10
C457001	5907708145703	ZINC GALVA Z275	100	75	140	2	34	5	4	11	-	-	23,65	ETA-07/0277 + CE	Vrac gencodé	10

Sabots poutre ailes extérieures

Sabot permettant une suspente sans fente entre les éléments assemblés.

Domaines d'utilisation :

Permet la fixation de solives, pannes, poutres, ...

Matière : Acier

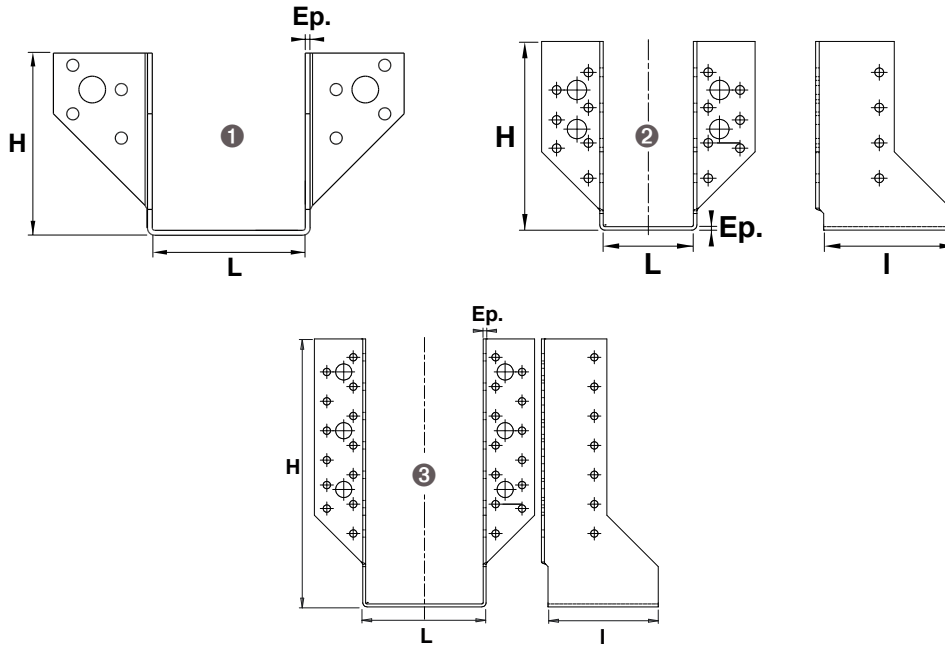
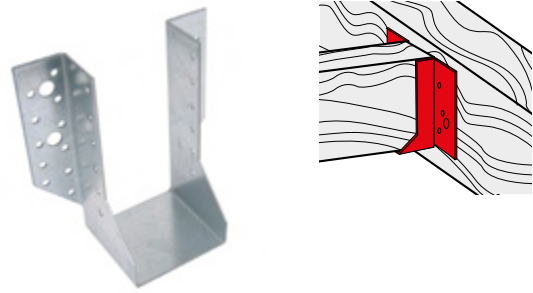

Code	Gencod	ZINC GALVA Z275	L	I	H	Ep.	Nb de trous	Ø de trous	Nb de trous	Ø de trous	Nb de trous	Ø de trous	Charge en [kN]	ETA	Type packaging	
C450102	3221684501028	ZINC GALVA Z275	32	75	89	2	12	5	2	11	-	-	12,56	ETA-09/0205 + CE	Vrac gencodé	10
3450922	3221684509222	ZINC GALVA Z275	50	75	80	2	12	5	2	11	-	-	18,14	ETA-09/0205 + CE	Vrac gencodé	10
① C451001	5907708145109	ZINC GALVA Z275	51	75	105	2	22	5	2	11	8	5	19	ETA-07/0277 + CE	Vrac gencodé	10
3451302	3221684513021	ZINC GALVA Z275	59	75	75	2	12	5	2	11	-	-	18,14	ETA-09/0205 + CE	Vrac gencodé	10
C451401	5907708145147	ZINC GALVA Z275	60	75	100	2	22	5	2	11	8	5	19	ETA-07/0277 + CE	Vrac gencodé	10
C451502	3221684515025	ZINC GALVA Z275	63	75	73	2	12	5	2	11	-	-	18,14	ETA-09/0205 + CE	Vrac gencodé	10
3450201	5907708145024	ZINC GALVA Z275	38	75	111	2	22	5	2	11	8	5	19	ETA-07/0277 + CE	Vrac gencodé	10
C450501	5907708145055	ZINC GALVA Z275	41	75	110	2	22	5	2	11	8	5	19	ETA-07/0277 + CE	Vrac gencodé	10
3450601	5907708145062	ZINC GALVA Z275	41	75	140	2	24	5	4	11	10	5	20,3	ETA-07/0277 + CE	Vrac gencodé	10
3450901	5907708145093	ZINC GALVA Z275	45	75	138	2	28	5	4	11	10	5	20,3	ETA-07/0277 + CE	Vrac gencodé	10
C451101	5907708145116	ZINC GALVA Z275	51	75	135	2	28	5	4	11	10	5	20,3	ETA-07/0277 + CE	Vrac gencodé	10
3451201	5907708145123	ZINC GALVA Z275	51	75	165	2	34	5	4	11	12	5	25,45	ETA-07/0277 + CE	Vrac gencodé	10
② C452001	5907708145208	ZINC GALVA Z275	64	75	128	2	28	5	4	11	10	5	20,3	ETA-07/0277 + CE	Vrac gencodé	10
C452201	5907708145222	ZINC GALVA Z275	70	75	155	2	34	5	4	11	12	5	25,45	ETA-07/0277 + CE	Vrac gencodé	10
C452301	5907708145239	ZINC GALVA Z275	76	75	122	2	28	5	4	11	10	5	20,3	ETA-07/0277 + CE	Vrac gencodé	10
C452401	5907708145246	ZINC GALVA Z275	76	75	152	2	34	5	4	11	12	5	25,45	ETA-07/0277 + CE	Vrac gencodé	10
C452601	5907708145260	ZINC GALVA Z275	80	75	120	2	28	5	4	11	10	5	20,3	ETA-07/0277 + CE	Vrac gencodé	10
C453001	5907708145307	ZINC GALVA Z275	100	75	140	2	34	5	4	11	12	5	25,45	ETA-07/0277 + CE	Vrac gencodé	10
3452501	5907708145253	ZINC GALVA Z275	76	75	182	2	40	5	6	11	14	5	27,75	ETA-07/0277 + CE	Vrac gencodé	10
C452801	5907708145284	ZINC GALVA Z275	80	75	180	2	40	5	6	11	14	5	27,75	ETA-07/0277 + CE	Vrac gencodé	10
③ C453201	5907708145321	ZINC GALVA Z275	100	75	200	2	46	5	6	11	16	5	32,3	ETA-07/0277 + CE	Vrac gencodé	10
C453501	5907708145352	ZINC GALVA Z275	120	75	160	2	40	5	6	11	14	5	27,75	ETA-07/0277 + CE	Vrac gencodé	10
C453701	5907708145376	ZINC GALVA Z275	140	75	180	2	30	5	6	11	16	5	32,3	ETA-07/0277 + CE	Vrac gencodé	10

Sabots à écart variable

Sabot permettant l'accroche de poutre non standard.

Domaines d'utilisation :

Permet la fixation de solives, reprise d'assemblage existants

Matière : Acier

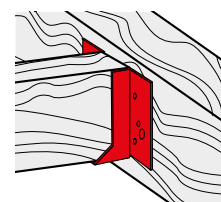

Sens gauche
C455101

Sens droite
C455201

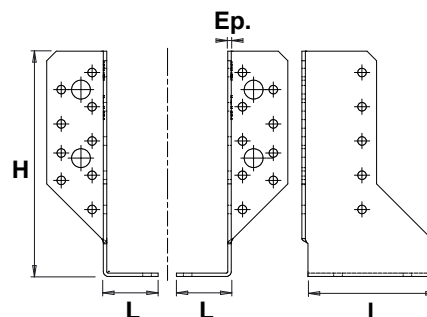

Code	Gencod		Sens	L	I	H	Ep.	Autre	Nb de trous	Ø de trous	Nb de trous	Ø de trous	Nb de trous	Ø de trous	Charge en [kN]	ETA	Type packaging	
C455101	5907708145512	ZINC GALVA Z275	GAUCHE	32	79	130	2	75	14	5	2	11	-	-	26,96	ETA-13/0124 + CE	Vrac gencodé	10
C455201	5907708145529	ZINC GALVA Z275	DROITE	32	79	130	2	75	14	5	2	11	-	-	26,96	ETA-13/0124 + CE	Vrac gencodé	10

Sabots à ailes pliables

Suspente de poutre pour construction légère.

Domaines d'utilisation :

Faux-plafonds, plancher, terrasse, solivette...

Matière : Acier

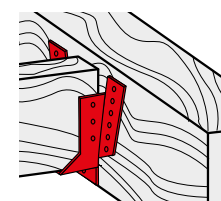

Code	Gencod		H	I	Ep.	Nb de trous	Ø de trous	Type packaging	
6407115	3221686407151	ZINC GALVA Z275	186	51	1	19	4	Vrac gencodé	10
6407117	3221686407175	ZINC GALVA Z275	188	47	1	19	4	Vrac gencodé	10

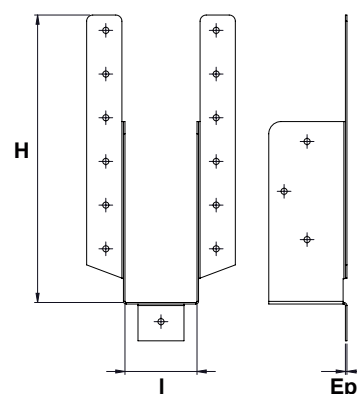

Chapeaux de poteau pointe diamant





Permet d'apporter l'esthétisme final aux poteaux.

Domaines d'utilisation :

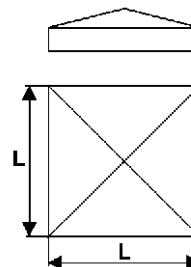
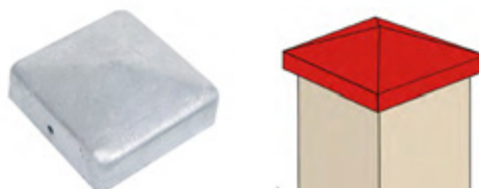
Poteaux de clôtures

Matière : Acier



Code	Gencod		L	Ep.	Type packaging	
3498501	5907708149855	GALVA.	70	1	Vrac gencodé	10
3498701	5907708149879	GALVA.	90	1	Vrac gencodé	10
M687115	3026726871158		72	1	Vrac gencodé	1
M687125	3026726871257		92	1	Vrac gencodé	1

Chapeaux de poteaux boule



Permet d'apporter l'esthétisme final aux poteaux.

Domaines d'utilisation :

Poteaux de clôtures

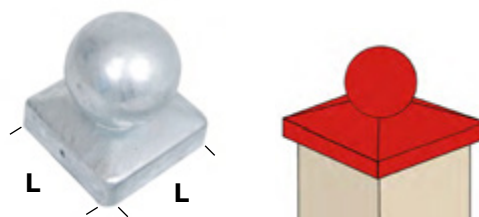
Matière : Acier



Code	Gencod		L	Ep.	Type packaging	
3499501	5907708149954	Z.BLANC	70	1	Vrac gencodé	10
3499701	5907708149978	Z.BLANC	90	1	Vrac gencodé	10





Pieds de poteau à enfoncer

Permet de fixer directement en terre.

Domaines d'utilisation :

Clôtures et constructions en bois légères

Matière : Acier

Code	Gencod		L1	L2	I	Ep.	Type packaging	
6411998	3221686411981	 GALVA.	750	146	71	2	Vrac gencodé	1
6411999	3221686411998	 GALVA.	750	146	91	2	Vrac gencodé	1
M687110	3026726871103		617	117	72	1,5	Vrac gencodé	1
M687130	3026726871301		617	117	92	1,5	Vrac gencodé	1

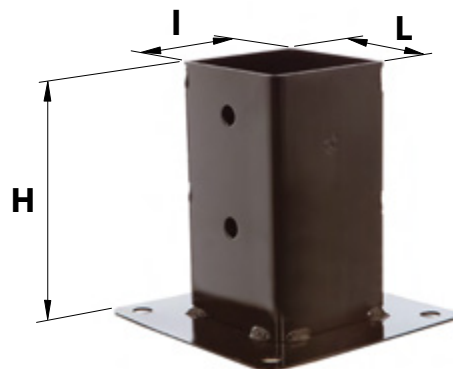
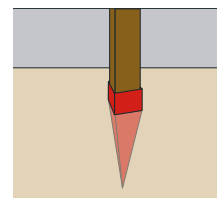
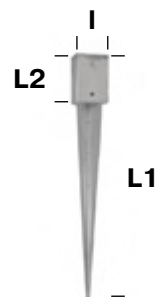





Pieds de poteau à visser

Permet de fixer sur sol béton.

Domaines d'utilisation :

Clôtures et constructions en bois légères

Matière : Acier

Code	Gencod		H	I	L	Ep.	Nb de trous	Ø de trous	Type packaging	
6411994	3221686411943	 GALVA.	150	71	71	2	8	11	Vrac gencodé	1
6411995	3221686411950	 GALVA.	150	91	91	2	8	11	Vrac gencodé	1
M687210	3026726872100		141	72	72	1,5	4	11	Vrac gencodé	1
M687230	3026726872308		141	92	92	1,5	4	11	Vrac gencodé	1

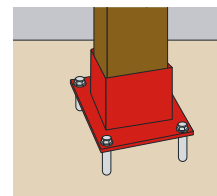
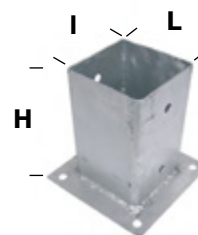

Pieds de poteau à visser 2 plaques

Pieds de poteau fixes couramment utilisés dans des applications structurelles.

Domaines d'utilisation :

Poteaux de auvent, pergolas, vérandas...

Matière : Acier

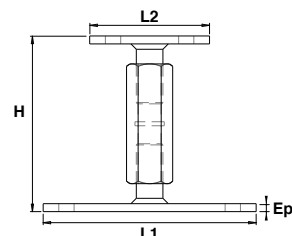
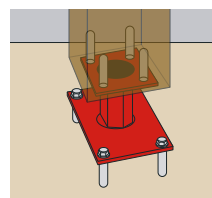

Code	Gencod		L1	L2	H	Ep.	Nb de trous	Ø de trous	Type packaging	
C481802	3221684818027	Z.BLANC	65	55	70	4	8	9	Vrac gencodé	1
C481803	3221684818034	Z.BLANC	140	100	100	4	8	9	Vrac gencodé	1

Pieds de poteau à vis réglable 2 plaques

Pieds de poteau réglables facilement en hauteur.

Domaines d'utilisation :

Poteaux de auvent, pergolas, vérandas...

Matière : Acier

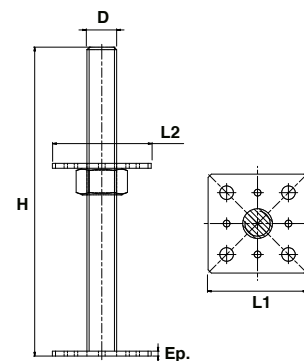
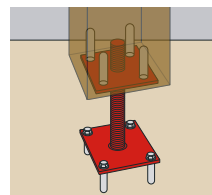

Code	Gencod		H	L1	L2	D	Ep.	Type packaging	
C488801	5907708148889	Z.BLANC	250	80	80	24	4	Vrac gencodé	1

Pieds de poteau à vis réglable 2 plaques

Pieds de poteau réglables facilement en hauteur.

Domaines d'utilisation :

Poteaux de auvent, pergolas, vérandas...

Matière : Acier

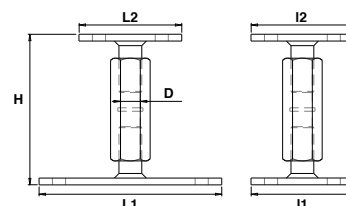
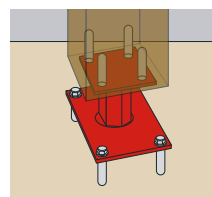

Code	Gencod		D	L1	L2	I1	I2	Ep.	H	ETA	Type packaging	
C481805	3221684818058	Z.BLANC	20	160	90	90	90	5	110/180	ETA-09/0205 + CE	Vrac gencodé	1

Ancre de poteau L à sceller

Pour ancrer et protéger les poteaux du pourrissement.

Domaines d'utilisation :

Poteaux de auvent, pergolas, vérandas...

Matière : Acier

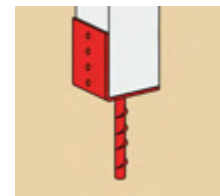
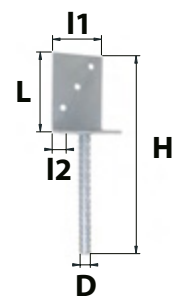

Code	Gencod		D	H	L	I1	I2	Ep.	Autre	Type packaging	
C480701	5907708148070	ZBLANC	18	335	135	90	90	5	90	Vrac gencodé	1

Ancre de poteau à larder à sceller

Pour ancrer et protéger les poteaux du pourrissement.

Domaines d'utilisation :

Poteaux de auvent, pergolas, vérandas...

Matière : Acier

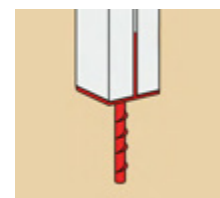
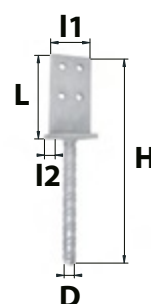

Code	Gencod		D	H	L	I1	I2	Ep.	Autre	Type packaging	
C493301	5907708148117	ZBLANC	16	336	138	70	70	8	70	Vrac gencodé	1

Ancre de poteau U à sceller

Pour ancrer et protéger les poteaux du pourrissement.

Domaines d'utilisation :

Poteaux de auvent, pergolas, vérandas...

Matière : Acier

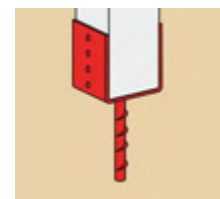
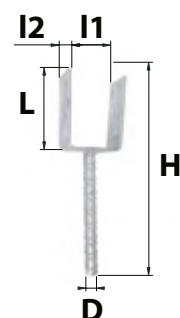

Code	Gencod		D	H	L	I1	I2	Ep.	Type packaging	
6411992	3221686411929	GALVA.	16	300	100	71	60	-	Vrac gencodé	1
6411993	3221686411936	GALVA.	20	330	100	91	60	-	Vrac gencodé	1
C480201	5907708148025	GALVA.	18	324	124	71	60	4	Vrac gencodé	1
C480301	5907708148032	GALVA.	18	324	120	81	60	4	Vrac gencodé	1
C480401	5907708148049	GALVA.	18	324	120	91	60	4	Vrac gencodé	1
C480501	5907708148056	GALVA.	18	324	120	101	60	4	Vrac gencodé	1

Équerres clôture bois avec vis

Permet l'assemblage des panneaux de palissade.

Domaines d'utilisation :

Palissades, clôtures de jardin, ...

Matière : Acier

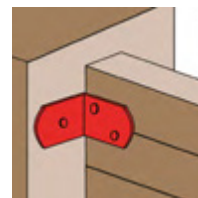
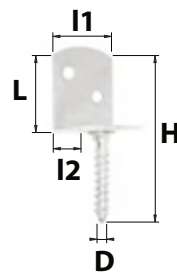

Code	Gencod		D	H	L	I1	I2	e	Nb de trous	Ø de trous	Type packaging	
6429003	3221686429030	GALVA.	6,6	80	37	35	33	2	2	7,5	Vrac gencodé	25
677803	3026726778037		6,6	80	37	35	33	2	2	7,5	Vrac gencodé	10

Équerres en U clôture bois avec vis

Permet l'assemblage des panneaux de palissade.

Domaines d'utilisation :

Palissades, clôtures de jardin, ...

Matière : Acier

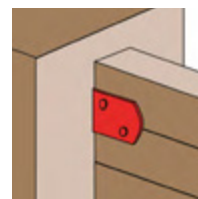

Code	Gencod		Type packaging	
6429004	3221686429047	GALVA.	Vrac gencodé	25

Pointes crantées

Préconisées pour l'assemblage structurelle des connecteurs

Domaines d'utilisation :

Sabot de charpente, équerres d'assemblage, plaques, ...

Matière : Acier



Code	Gencod		L	D	Type packaging	
0890800	5906718900265	Z.BLANC	40	4		1 boîte 1 kg
0890900	5906718900326	Z.BLANC	50	4		1 boîte 1 kg



Piquets de tiers tête ronde

Les piquets de tiers sont à enfoncer dans le sol pour définir la limitation des enclos.

Domaines d'utilisation :

Jardin

Matière : Acier

Code	Gencod		L	D	Type packaging	
789035	3026727890356	BRUT	300	18	Vrac gencodé	1
789040	3026727890400	BRUT	400	18	Vrac gencodé	1

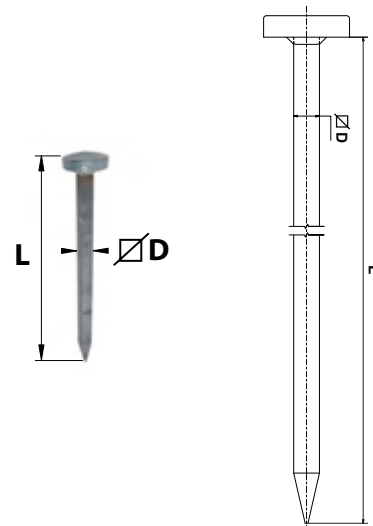

Piquets de tiers tête tournante

Les piquets de tiers sont à enfoncer dans le sol pour définir la limitation des enclos.

Domaines d'utilisation :

Jardin

Matière : Acier

Code	Gencod		L	D	Type packaging	
790040	3026727900406	BRUT	400	18	Vrac gencodé	1

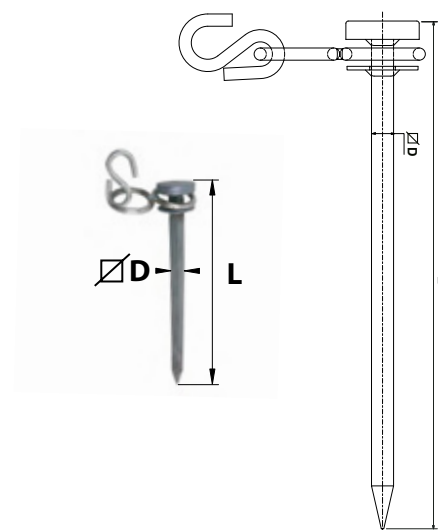

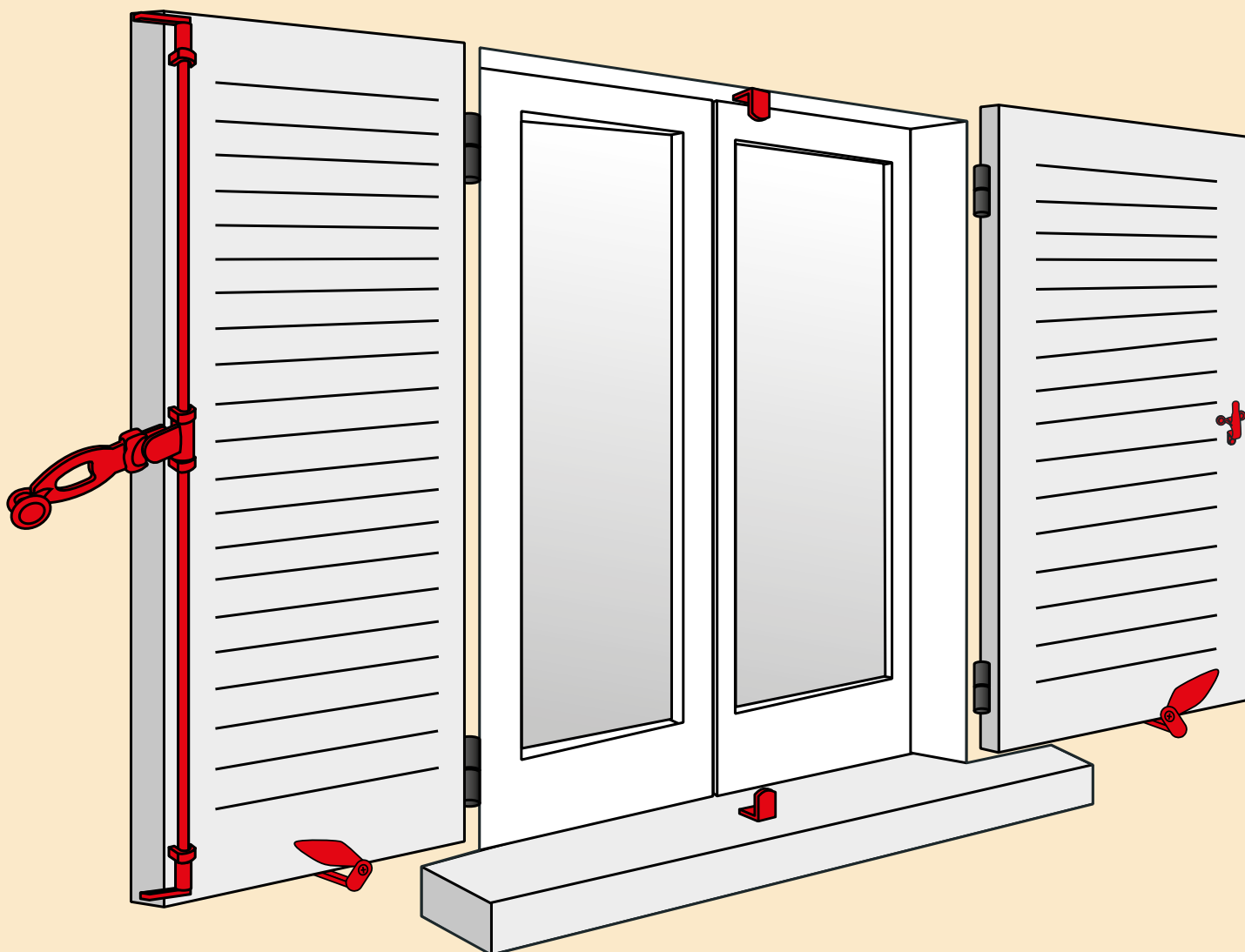

L'EXTÉRIEUR DE L'HABITAT

CONSEILS DE POSE

Précautions d'emploi

Les pentures doivent être posées perpendiculairement à la rive du volet.
Les noeuds de pentures doivent être rigoureusement alignés.

Si la façade est réalisée après la pose des volets et si les volets sont déposés, il faut impérativement nettoyer les gonds des projections de béton avant la repose du volet.

Pour un bon fonctionnement, graisser légèrement les gonds en acier, mais surtout pas ceux en composite qui sont autolubrifiants.

Important

La mise en œuvre des fermetures est encadrée par le DTU 34-4.
Ce document précise entre autre :

- L'axe des trous de fixation par cheville dans la maçonnerie doit être situé à au moins 60 mm des arêtes. Cette valeur est limitée à 35 mm pour les trous de diamètre inférieur ou égal à 8 mm sauf en cas d'utilisation de chevilles métalliques à expansion. Cette limitation ne concerne pas les scellements chimiques.
- L'organe de commande des arrêts de volets doit être situé à au plus 600 mm (A+B) du dormant de la menuiserie ou du garde-corps.
- Pour limiter la prise au vent des volets ouverts, la distance entre le mur et le volet, mesurée au bord libre du volet (D'), doit être inférieure ou égale cette même distance mesurée au bord articulé du volet (D).
- La valeur C indique la position de l'application de l'arrêt.

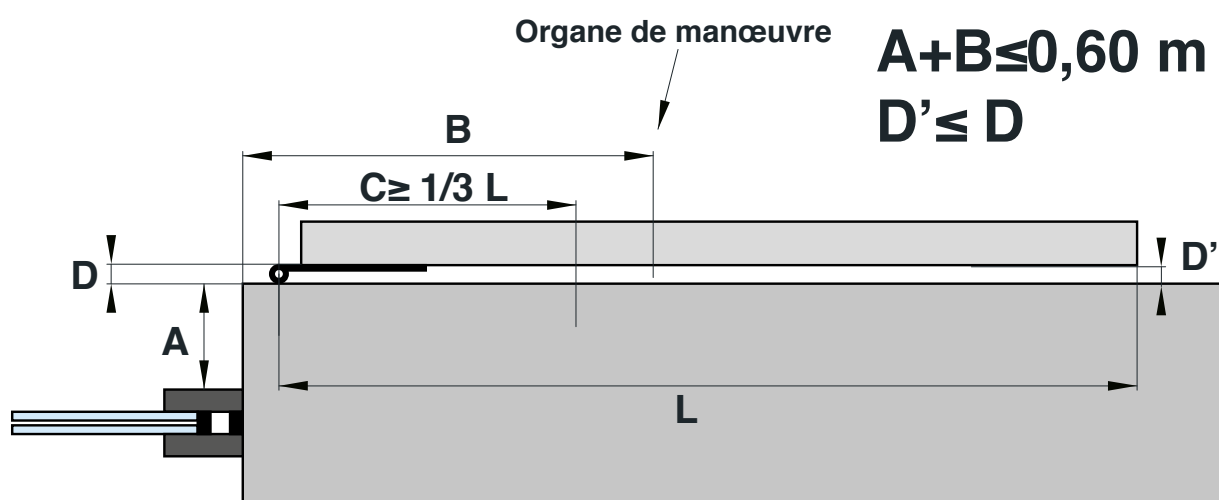

1

Définir sa configuration de baie

1 vantail

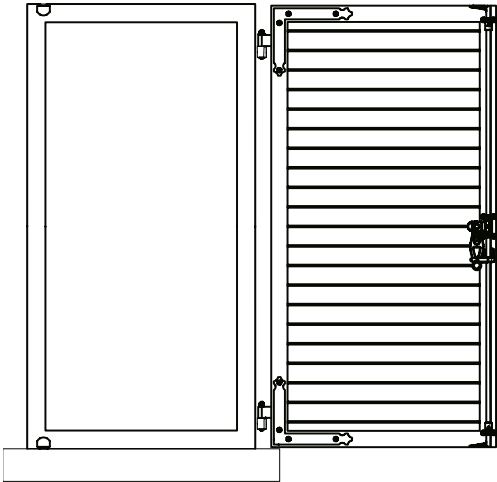

2 vantaux

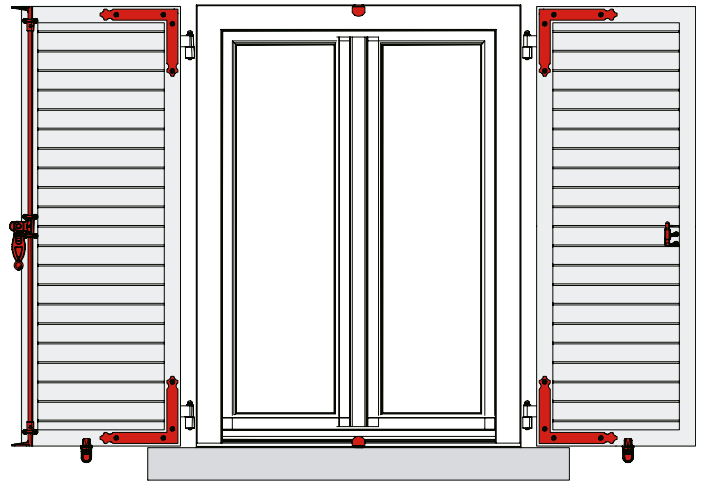

3 vantaux

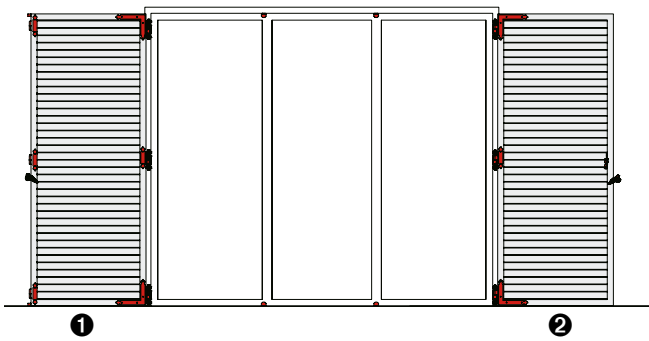

4 vantaux

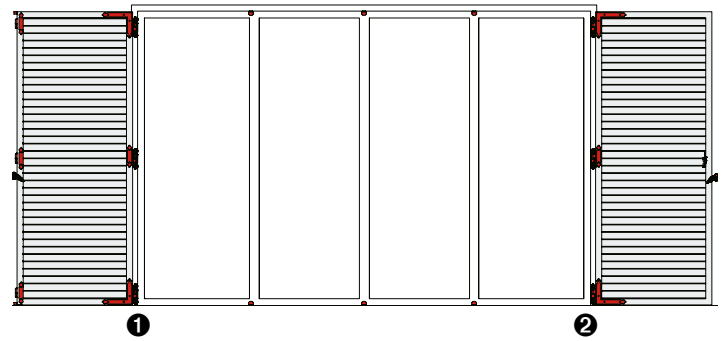

① Côté gauche



② Côté droit



① Côté gauche

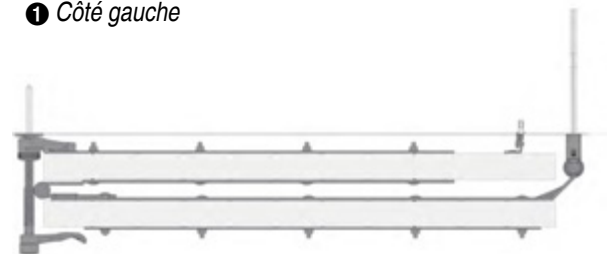

② Côté droit

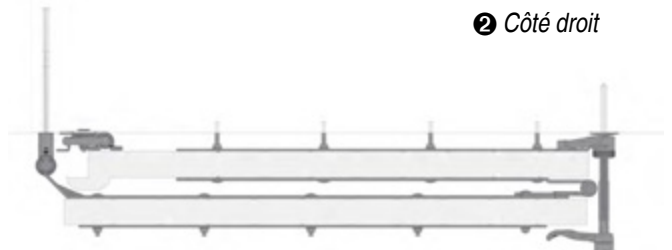

2

Choisir ses accessoires

1 vantail

Volet plein

OU

Volet à cadre

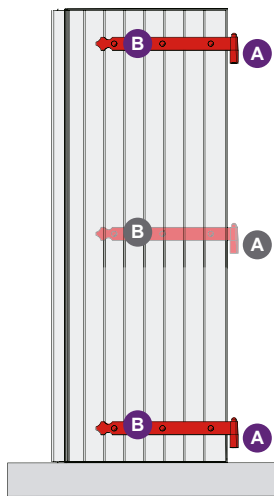

- A** 2 ou 3 gonds
- B** 2 ou 3 pentures

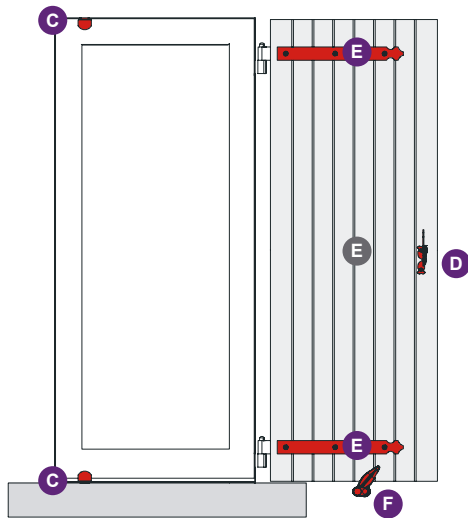

- C** 2 dardennes
- D** 1 espagnolette
1 sachet d'accessoires pour espagnolette + tringle
- E** 2 ou 3 contre-pentures
- F** 1 arrêt

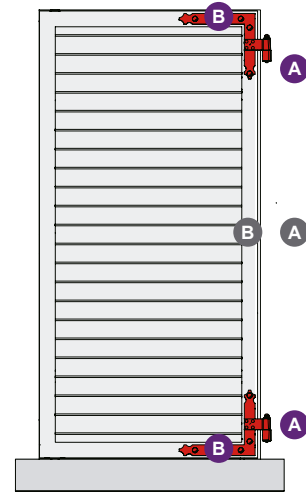

- A** 2 ou 3 gonds
- B** 2 équerres ou 2 équerres + 1 té

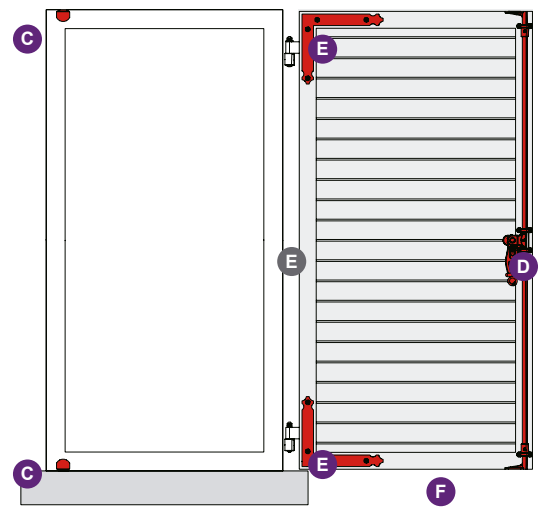

- C** 2 dardennes
- D** 1 espagnolette
1 sachet d'accessoires pour espagnolette + tringle
- E** 2 contre-équerres
ou 2 contre-équerres et 1 contre-té
- F** 1 arrêt

2.1

Combien de pentures ?

Fenêtre hauteur <1800 mm	2
Porte-fenêtre hauteur >1800 mm (max. 2500 mm)	3

2.2

Longueurs des pentures ?

Largeur vantail (mm) (max. 800 mm)	350 à 440	450 à 540	550 à 640	650 à 800
	300	400	500	600
Longueur pentures (mm)				

2

Choisir ses accessoires

2 vantaux

Volet plein

OU

Volet à cadre

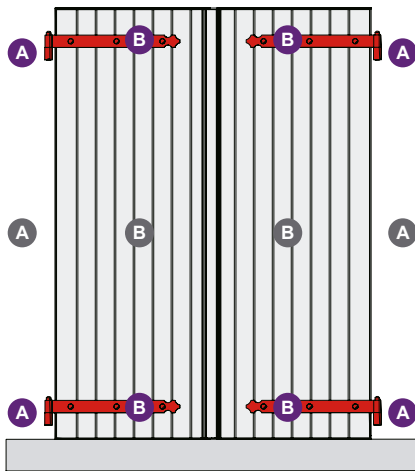

- A 4 ou 6 gonds
- B 4 ou 6 pentures

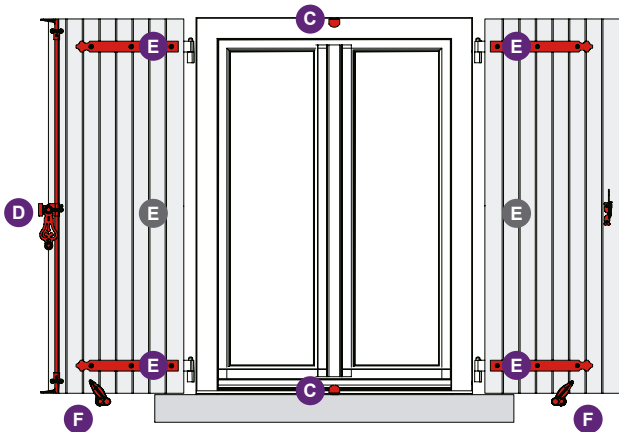

- C 2 dardennes
- D 1 espagnolette
1 sachet d'accessoires pour espagnolette + tringle
- E 4 ou 6 contre-pentures
- F 2 arrêts

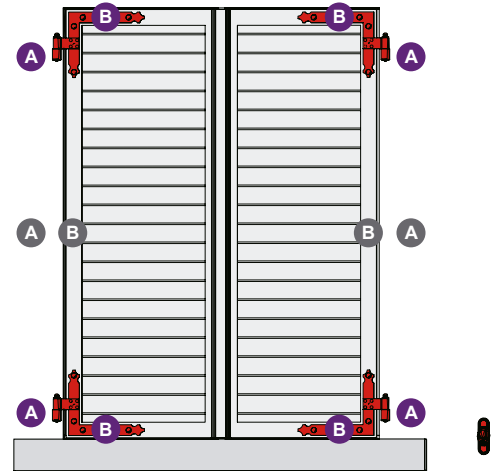

- A 4 ou 6 gonds
- B 4 équerres ou 4 équerres + 2 tés

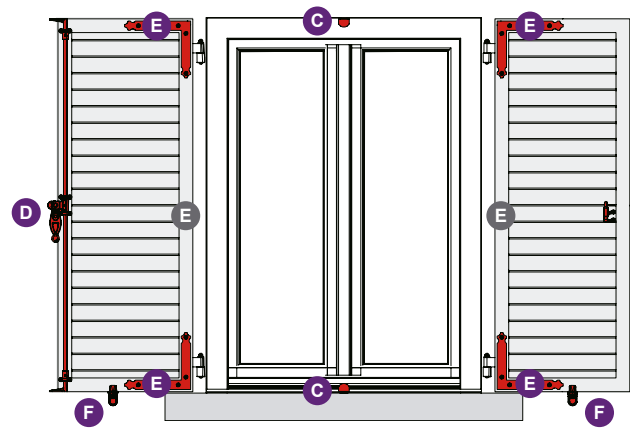

- C 2 dardennes
- D 1 espagnolette
1 sachet d'accessoires pour espagnolette + tringle
- E 4 contre-équerres
ou 4 contre-équerres et 2 contre-tés
- F 2 arrêts

2.1

Combien de pentures ?

Fenêtre hauteur <1800 mm	4
Porte-fenêtre hauteur >1800 mm (max. 2500 mm)	6

2.2

Longueurs des pentures ?

Largeur vantail (mm) (max. 800 mm)	350 à 440	450 à 540	550 à 640	650 à 800
	300	400	500	600
Longueur pentures (mm)				

2

Choisir ses accessoires

3 vantaux

Volet plein

OU

Volet à cadre

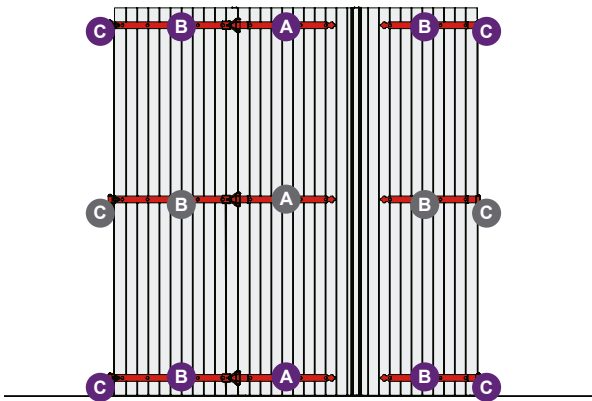

- A** 4 ou 6 pentures
- B** 2 ensembles Torbel QC ou 2 H ou 2 charnières
- C** 4 ou 6 gonds

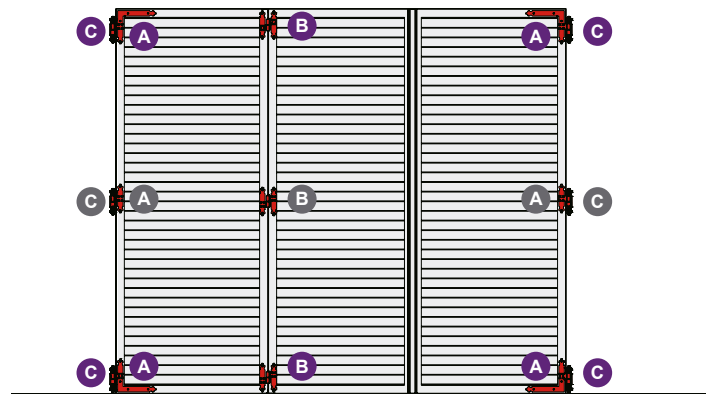

- A** 4 équerres ou 4 équerres + 2 tés
- B** 2 ou 3 H
- C** 4 ou 6 gonds

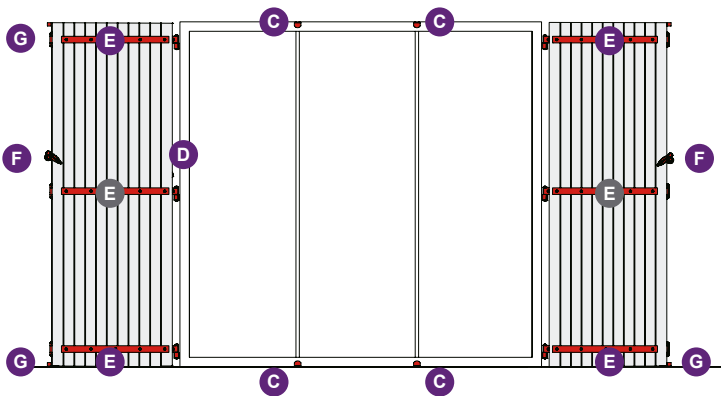

- C** 4 dardennes
- D** 1 espagnolette
1 sachet d'accessoires pour espagnolette + triangle
- E** 4 ou 6 contre-pentures ou 2 contre-pentures et 2 contre-tés
- F** 2 arrêts
- G** 2 crochets de rappel

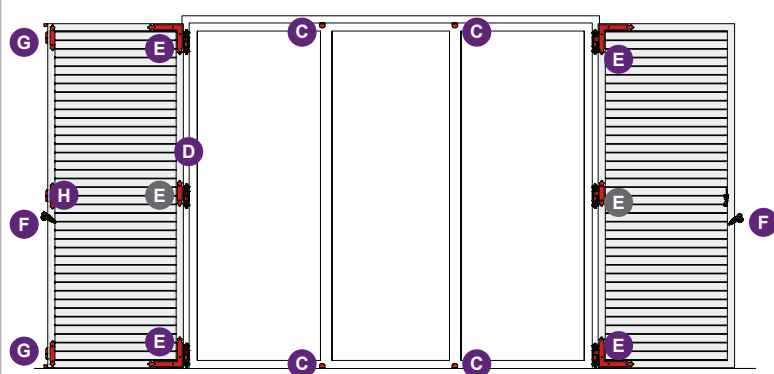

- C** 4 dardennes
- D** 1 espagnolette
1 sachet d'accessoires pour espagnolette + triangle
- E** 4 contre-équerres ou 4 contre-équerres et 2 contre-tés
- F** 2 arrêts
- G** 2 crochets de rappel
- H** 4 contre-tés

2.1

Combien de pentures ?

Fenêtre hauteur <1800 mm	2 pentures + 2 pentures double
Porte-fenêtre hauteur >1800 mm (max. 2500 mm)	3 pentures + 3 pentures double

2.2

Longueurs des pentures ?

Largeur vantail (mm) (max. 800 mm)	350 à 440	450 à 540	550 à 640	650 à 800
	300	400	500	600
Longueur pentures (mm)				

2

Choisir ses accessoires

4 vantaux

Volet plein

OU

Volet à cadre

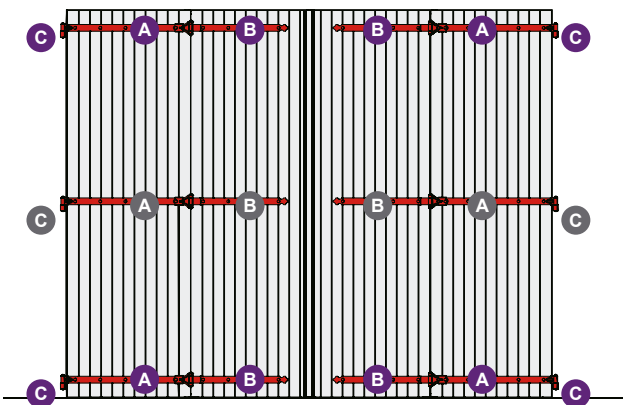

- A 4 ou 6 pentures
- B 2 ensembles Torbel QC ou 2 H ou 2 charnières
- C 4 ou 6 gonds

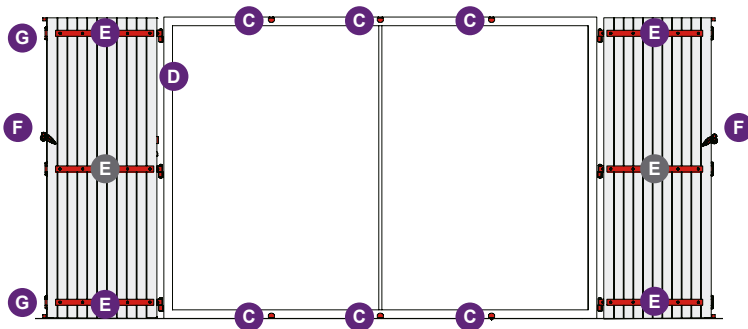

- C 4 dardennes
- D 1 espagnolette
1 sachet d'accessoires pour espagnolette + tringle
- E 4 ou 6 contre-pentures ou 2 contre-pentures et 2 contre-tés
- F 2 arrêts
- G 2 crochets de rappel

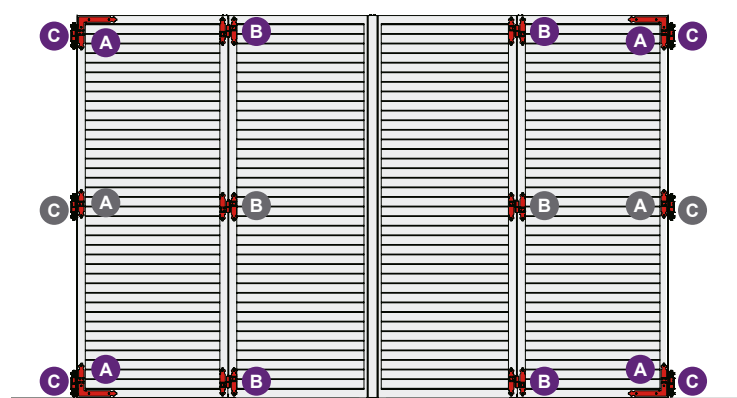

- A 4 équerres ou 4 équerres + 2 tés
- B 2 ou 3 H
- C 4 ou 6 gonds

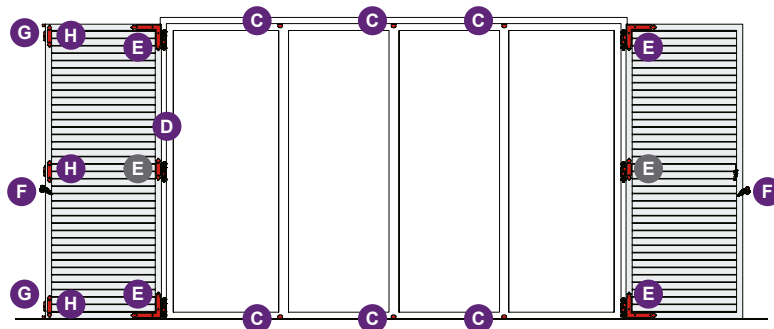

- C 4 dardennes
- D 1 espagnolette
1 sachet d'accessoires pour espagnolette + tringle
- E 4 contre-équerres ou 4 contre-équerres et 2 contre-tés
- F 2 arrêts
- G 2 crochets de rappel
- H 8 contre-tés

2.1

Combien de pentures ?

Fenêtre hauteur <1800 mm	4 pentures double
Porte-fenêtre hauteur >1800 mm (max. 2500 mm)	4 pentures double

2.2

Longueurs des pentures ?

Largeur vantail (mm) (max. 800 mm)	350 à 440	450 à 540	550 à 640	650 à 800
	300	400	500	600
Longueur pentures (mm)				

3

Choisir les gonds adaptés à son mur

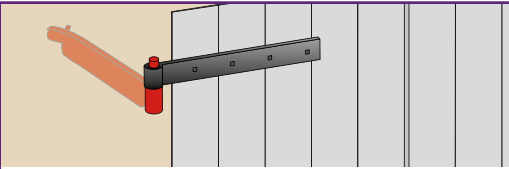
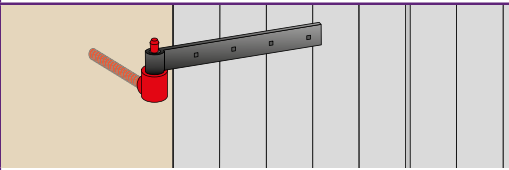
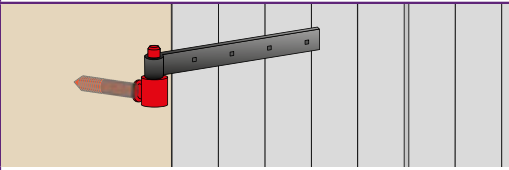
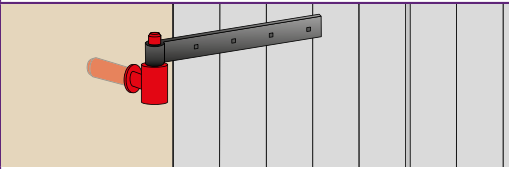
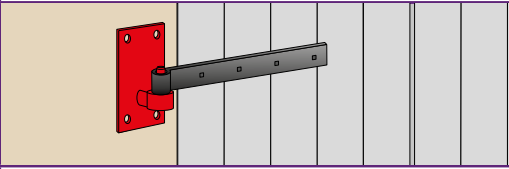
	Béton	Pierre	Parpaing	Bois
 <p>Montage avec scellement traditionnel</p>	●	●	●	
 <p>Montage avec scellement chimique</p>	●	●	●	
 <p>Montage direct avec le tirefond du gond</p>	●	●	●	●
 <p>Montage avec cheville 4 segments</p>	●	●		
 <p>Montage avec vis</p>	●		●	●



Prévoir autant de gonds que de pentures.
Penser aux rondelles pour bien ajuster les volets sur les gonds.

4

Choisir les arrêts adaptés à son mur

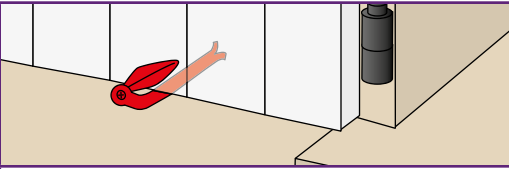
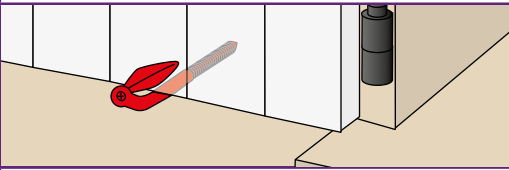
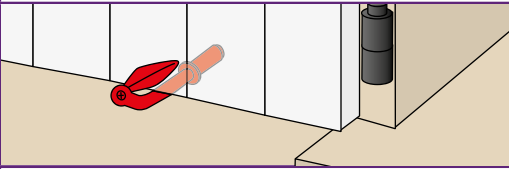
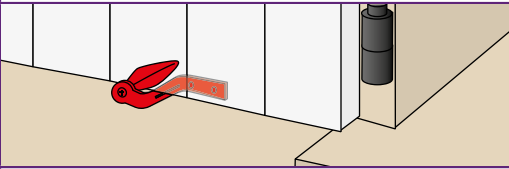
	Béton	Pierre	Parpaing	Bois
 <p>A sceller</p>	●	●	●	
 <p>A visser</p>	●	●	●	●
 <p>A scellement chimique</p>	●	●		
 <p>A visser sur plaque</p>	●	●		

Pour vos volets difficiles d'accès !

Pensez aux systèmes autobloquants qui vous évitent de vous pencher et permettent une manipulation plus facile du volet.

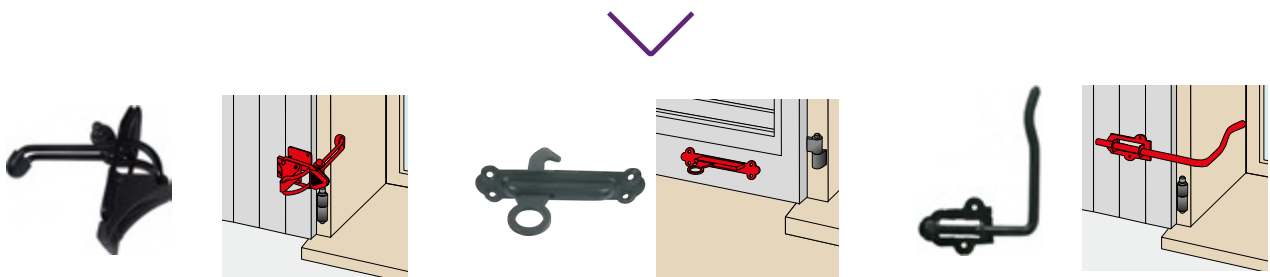

5

Poser ses pentures

LE DEPORT varie selon la nature du matériau



DEPORT EN MM (D)

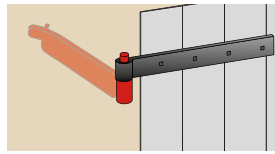

Gond à sceller :
12 à 50 mm

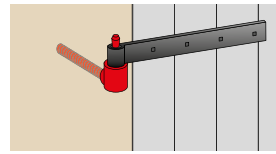

Gond à visser :
Mini 50 mm

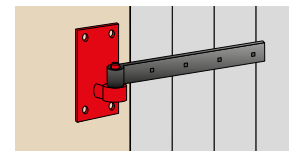

Gond sur plaque :
40 à 50 mm

Penture simple

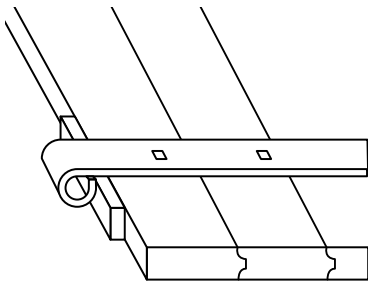

1. Caler le noeud de la penture à l'envers.

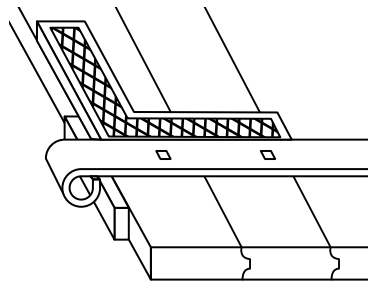

2. Contrôler l'équerrage.

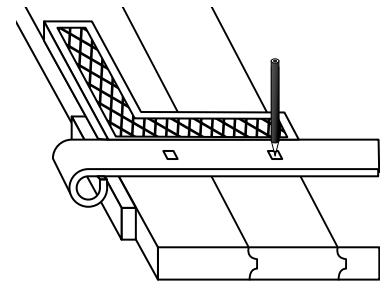

3. Tracer les trous.

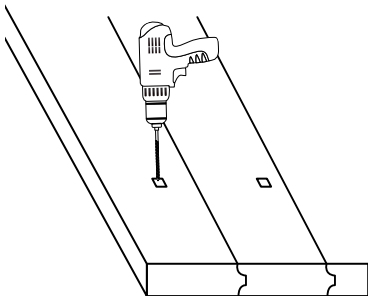

4. Percer les trous.

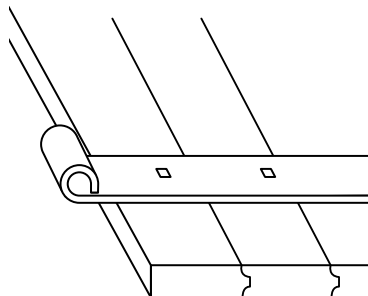

5. Positionner la penture dans le bon sens.

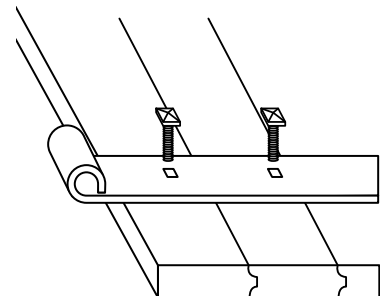

6. Visser les boulons.

Ensemble vantaux doubles

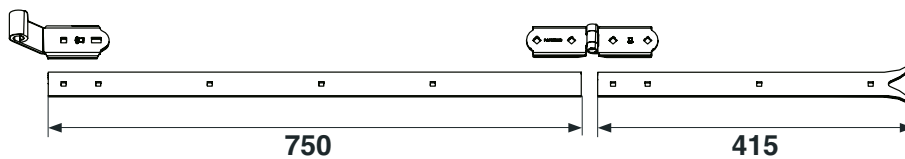
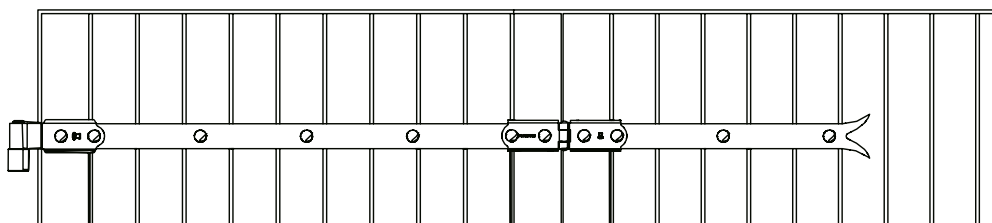

1. Recouper la pièce de 750 mm à la dimension du 1er vantail.
2. Contrepercer 2 trous dans la pièce charnière gabarit.
3. Percer les trous de fixation dans le volet.
4. Assembler les boulons.

6

Poser son espagnolette ou son crochet

Volet < L1,40 m

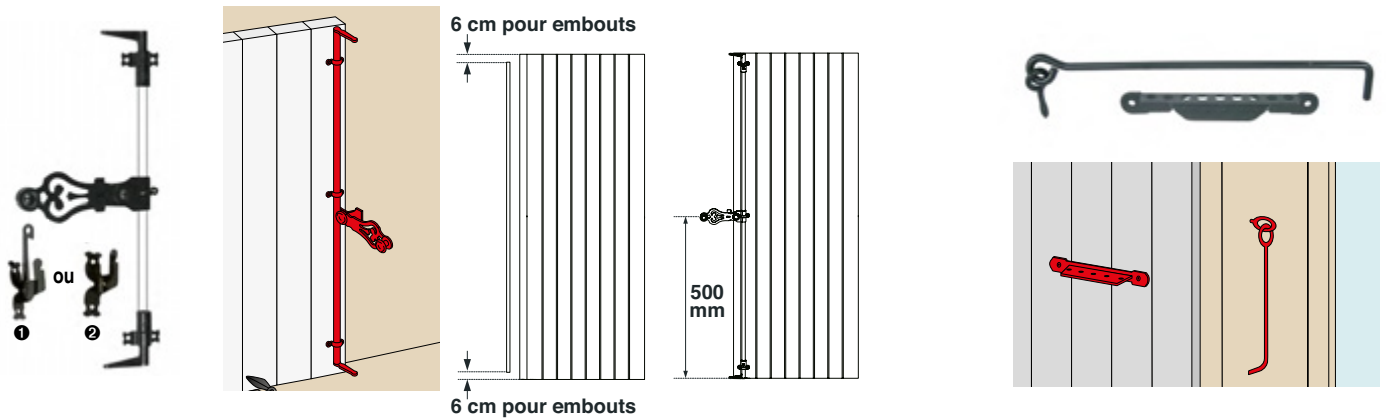

> Espagnolette Standard

Idéale pour fermer et entrebâiller vos volets.
 Choisissez un sachet d'accessoires
 ainsi qu'une tringle pour former votre espagnolette.

+ PRODUIT

Choisissez les accessoires avec support de poignée
 antisoulèvement ❶ ou standard ❷.

> Crochet crémaillère

Fermer et entrebâiller vos volets.

7 Poser ses gonds

Caler les vantaux

- Assurer un jeu central
 en pointant 2 cales sur un vantail :
 - Cale de 8 mm en haut
 - Cale de 4 mm en bas

Présenter le volet dans la baie

- Répartir le jeu sur la périphérie.
- Vérifier l'aplomb.
- Caler en force le volet sur les 2 tableaux.



*Pour faciliter la pose du gond,
 utiliser le gabarit de perçage !*

IMPORTANT :

*Respecter le mode opératoire
 spécifique au type de gond.*

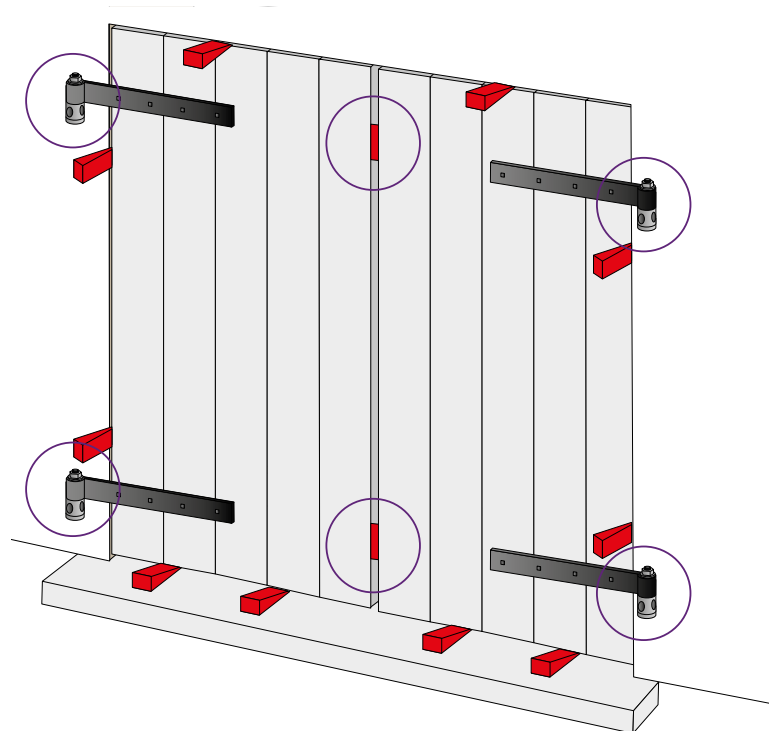

8 Poser ses arrêts



Accéder au
DTU 34-4

La mise en œuvre des fermetures est encadrée
par le DTU 34-4, s'y référer pour éviter tout danger.

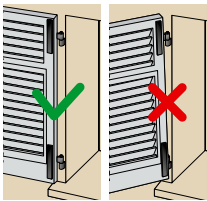

Bien s'assurer que le vantail soit monté
plaqué et serré sur la façade.



En cas de vent,
fermer les volets.



Pour les volets de grandes tailles,
utiliser uniquement les arrêts adaptés



Plus d'infos sur
www.afbat.com

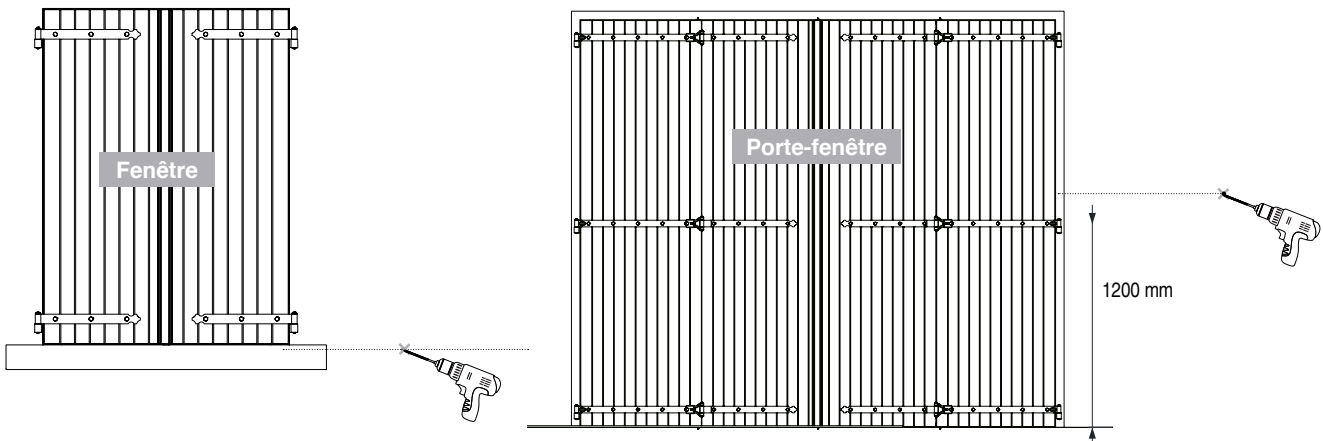

1. Tracer l'emplacement des trous
en respectant le DTU 34-4 ($C > 1/3 L$)
 2. Percer.
 3. Placer les chevilles.
 4. Placer l'arrêt.
- * Suivant le modèle, adapter la hauteur.

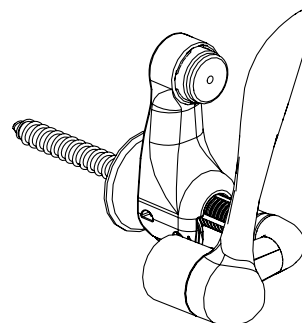

8

Poser ses arrêts

Mise en garde spécifique pour les arrêts de volet à poignée de type :
Verrouilvolet, blocvolet, blocboy...

	<p>Contrôler la surface maximum et le poids du volet préconisés (cf page catalogue du produit)</p>
	<p>Ne pas utiliser en zone venteuse.</p>
	<p>En cas de vent, fermer les volets.</p>
	<p>Utiliser TOUS les trous de fixation prévus à cet effet pour fixer la pièce.</p>
	<p>Vérifier le serrage régulièrement.</p>

9

Sécuriser son volet

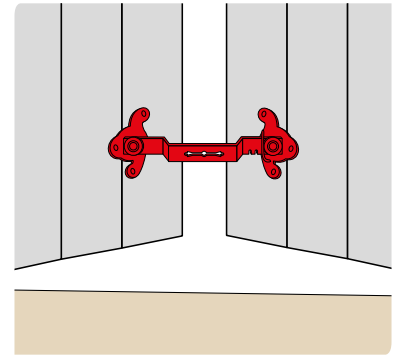
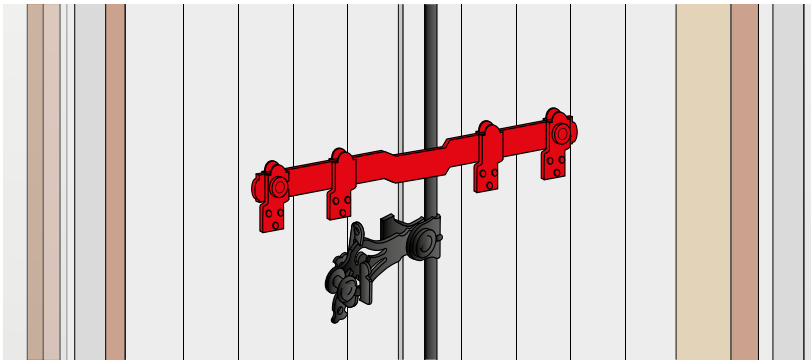

> Barre de sécurité

Système 4 points antisoulèvement.

> Entrebâilleur de sécurité

Indéverrouillable de l'extérieur.



- ① Supports droits
- ② Supports antisoulèvements

Les barres de sécurité se fixent à l'aide de supports droits en partie centrale et de supports antisoulèvements aux extrémités.

Pour des barres de sécurité L120 cm : 2x① + 2x②

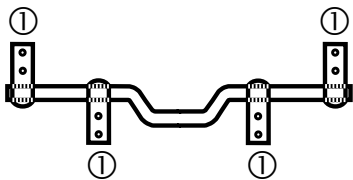

- ① Supports droits

Pour assurer la fonction antisoulèvement, les supports positionnés aux extrémités peuvent être remplacés par des supports simples en position inversée.

Pour des barres de sécurité L44 et L120 cm : 4x①



L'EXTÉRIEUR DE L'HABITAT

LE VOLET BOIS

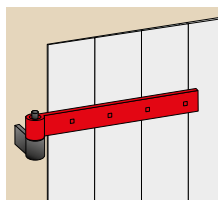

Penture bout droit

Code	Gencod		D	L	I	Ep.	Type packaging		
30x4									
0662601	3308180035698		14	300	30	4	Vrac gencodé	5	
0662701	3308180035704		14	400	30	4	Vrac gencodé	5	
0662801	3308180035711		14	500	30	4	Vrac gencodé	5	
0662603	3308186626036	Z.BLANC	14	300	30	4	Vrac gencodé	5	
0662703	3308186627033	Z.BLANC	14	400	30	4	Vrac gencodé	5	
0662803	3308180038750	Z.BLANC	14	500	30	4	Vrac gencodé	5	
35x4									
0663001	3308180035735		14	300	35	4	Vrac gencodé	5	
0663101	3308180035742		14	400	35	4	Vrac gencodé	5	
0663201	3308180035759		14	500	35	4	Vrac gencodé	5	
0663401	3308180035766		14	600	35	4	Vrac gencodé	5	
0663601	3308180035773		14	700	35	4	Vrac gencodé	5	
0663701	3308180035780		14	800	35	4	Vrac gencodé	5	
0663003	3308180037265	Z.BLANC	14	300	35	4	Vrac gencodé	5	
0663103	3308180038408	Z.BLANC	14	400	35	4	Vrac gencodé	5	
0663203	3308186632037	Z.BLANC	14	500	35	4	Vrac gencodé	5	
0663403	3308186634031	Z.BLANC	14	600	35	4	Vrac gencodé	5	
0663603	3308186636035	Z.BLANC	14	700	35	4	Vrac gencodé	5	
0663703	3308186637032	Z.BLANC	14	800	35	4	Vrac gencodé	5	
0943201	3308189432016		14	300	35	4		20	
0943301	3308189433013		14	400	35	4		20	
0943401	3308189434010		14	500	35	4		10	
0943501	3308189435017		14	600	35	4		10	
35x5									
0977201	3308189772013		14	300	35	5	Vrac gencodé	5	
1113201	3308181132013		14	400	35	5	Vrac gencodé	5	
1113101	3308181131016		14	500	35	5	Vrac gencodé	5	
0733601	3308180035797		14	600	35	5	Vrac gencodé	5	
0733801	3308180035803		14	700	35	5	Vrac gencodé	5	
0786901	3308180035827		14	800	35	5	Vrac gencodé	5	
40x5									
0733901	3308187339010		14	800	40	5	Vrac gencodé	5	
0265401	3308182654019		14	1000	40	5	Vrac gencodé	5	
0707306	3308187073006	DP	14	300	40	5	Vrac gencodé	5	
0707406	3308187074003	DP	14	400	40	5	Vrac gencodé	5	
0707506	3308187075000	DP	14	500	40	5	Vrac gencodé	5	
0707606	3308187076007	DP	14	600	40	5	Vrac gencodé	5	
0787901	3308180035865		16	800	40	5	Vrac gencodé	5	
0789101	3308180035940		16	1000	40	5	Vrac gencodé	5	
0797701	3308180035988		16	1200	40	5	Vrac gencodé	5	
0787903	3308180035872	Z.BLANC	16	800	40	5	Vrac gencodé	5	
0789103	3308180035957	Z.BLANC	16	1000	40	5	Vrac gencodé	5	
0797703	3308180035995	Z.BLANC	16	1200	40	5	Vrac gencodé	5	
40x6									
0977301	3308189773010		14	300	40	6	Vrac gencodé	5	
0977401	3308189774017		14	400	40	6	Vrac gencodé	5	
0977501	3308189775014		14	500	40	6	Vrac gencodé	5	
0977601	3308189776011		14	600	40	6	Vrac gencodé	5	
0977701	3308189777018		14	700	40	6	Vrac gencodé	5	
0977801	3308189778015		14	800	40	6	Vrac gencodé	5	
0977901	3308189779012		14	1000	40	6	Vrac gencodé	5	

Pentures coudées bout droit

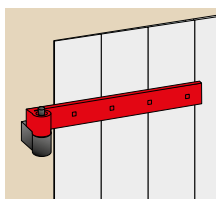

Penture coudée bout droit

Code	Gencod		D	L	I	Ep.	Type packaging	
35x4								
0793801	3308180036879		14	400	35	4	Vrac gencodé	1
0794601	3308180036916		14	500	35	4	Vrac gencodé	1
0794701	3308180038590		14	600	35	4	Vrac gencodé	1

Pentures queue de carpe

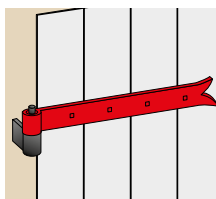
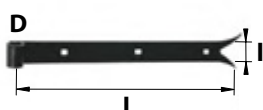

Penture bout queue de carpe

Code	Gencod		D	L	I	Ep.	Type packaging	
30x4								
0663801	3308180036053		14	300	30	4	Vrac gencodé	5
0663901	3308180036060		14	400	30	4	Vrac gencodé	5
0664801	3308180036077		14	500	30	4	Vrac gencodé	5
0663803	3308186638039	Z.BLANC	14	300	30	4	Vrac gencodé	5
0663903	3308186639036	Z.BLANC	14	400	30	4	Vrac gencodé	5
0664803	3308180038781	Z.BLANC	14	500	30	4	Vrac gencodé	5
35x4								
0665801	3308180036091		14	300	35	4	Vrac gencodé	5
0665901	3308180036107		14	400	35	4	Vrac gencodé	5
0667001	3308180036114		14	500	35	4	Vrac gencodé	5
0667501	3308180036121		14	600	35	4	Vrac gencodé	5
0667701	3308180036138		14	700	35	4	Vrac gencodé	5
0667801	3308180036145		14	800	35	4	Vrac gencodé	5
0665803	3308180038415	Z.BLANC	14	300	35	4	Vrac gencodé	5
0665903	3308180038422	Z.BLANC	14	400	35	4	Vrac gencodé	5
0667003	3308186670039	Z.BLANC	14	500	35	4	Vrac gencodé	5
0667703	3308186677038	Z.BLANC	14	700	35	4	Vrac gencodé	5
0943601	3308189436014		14	300	35	4		20
0943701	3308189437011		14	400	35	4		20
0943801	3308189438018		14	500	35	4		10
0943901	3308189439015		14	600	35	4		10
35x5								
0808501	3308188085015		14	300	35	5	Vrac gencodé	5
0808701	3308188087019		14	400	35	5	Vrac gencodé	5
0808901	3308188089013		14	500	35	5	Vrac gencodé	5
0809101	3308188091016		14	600	35	5	Vrac gencodé	5
40x5								
0735501	3308187355010		14	800	40	5	Vrac gencodé	5
0265501	3308182655016		14	1000	40	5	Vrac gencodé	5
0788301	3308180036220		16	800	40	5	Vrac gencodé	5
0789301	3308180036305		16	1000	40	5	Vrac gencodé	5
0797801	3308180036343		16	1200	40	5	Vrac gencodé	5

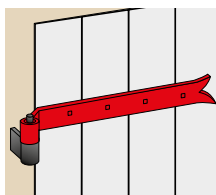
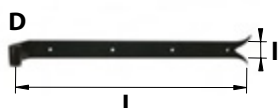

Penture col équerre bout queue de carpe

Code	Gencod		D	L	I	Ep.	Type packaging	
35x4								
0785601	3308187856012		14	500	35	4	Vrac gencodé	1
0785701	3308187857019		14	600	35	4	Vrac gencodé	1

Equerres bout droit

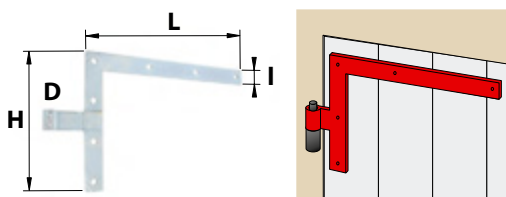
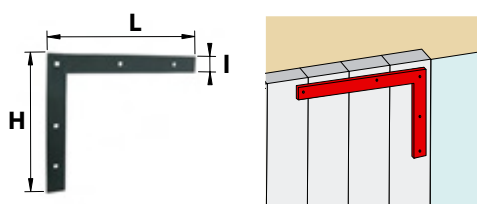
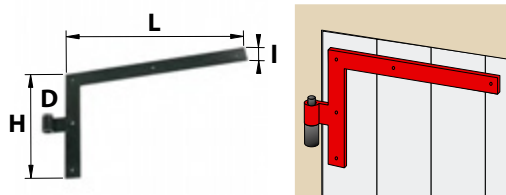

Equerre bout droit

Code	Gencod		D	L	H	I	Ep.	Déport	Type packaging	
Modèle haut gauche / bas droit										
0819701	3308180037616		14	300	250	35	4	50	Vrac gencodé	1
Modèle haut droit / bas gauche										
0819601	3308180037579		14	300	250	35	4	50	Vrac gencodé	1
La paire										
0389701	3308183897019		14	300	250	35	4	50	Vrac gencodé	1
0944001	3308189440011		14	300	250	35	4	50		4
Modèle haut gauche / bas droit										
176010	3221681760107		16	800	400	40	6	37	Vrac gencodé	1
Modèle haut droit / bas gauche										
176011	3221681760114		16	800	400	40	6	37	Vrac gencodé	1

Contre-équerre bout droit

Code	Gencod		L	H	I	Ep.	Type packaging	
0459401	3308184594016		300	250	35	4	Vrac gencodé	1

Equerre bout droit

Code	Gencod		D	L	H	I	Ep.	Déport	Type packaging	
Modèle haut gauche / bas droit										
752805	3026727528051	Z.BLANC	14	300	220	30	4	55	Vrac gencodé	4
Modèle haut droit / bas gauche										
752804	3026727528044	Z.BLANC	14	300	220	30	4	55	Vrac gencodé	4

Equerres queue de carpe

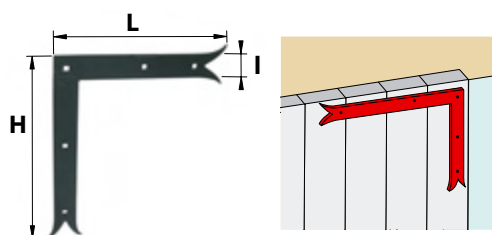
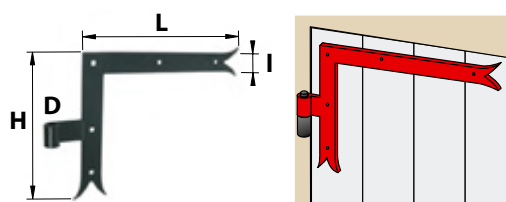

Equerre bout queue de carpe

Code	Gencod		D	L	H	I	Ep.	Déport	Type packaging	
Modèle haut gauche / bas droit										
0793201	3308180037739		14	300	250	35	4	50	Vrac gencodé	1
Modèle haut droit / bas gauche										
0793401	3308180037692		14	300	250	35	4	50	Vrac gencodé	1
La paire										
0382801	3308183828013		14	300	250	35	4	50	Vrac gencodé	1

Contre-équerre bout queue de carpe

Code	Gencod		L	H	I	Ep.	Type packaging	
0792801	3308180037814		300	250	35	4	Vrac gencodé	1

Tés bout droit

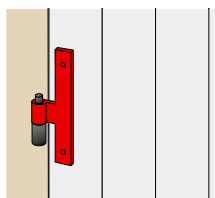
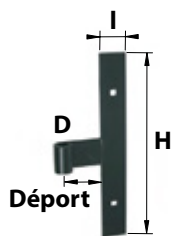

Té bout droit

Code	Gencod		D	H	I	Ep.	Déport	Type packaging	
0819801	3308180037654		14	250	35	4	50	Vrac gencodé	1
0819803	3308180037661	Z.BLANC	14	250	35	4	50	Vrac gencodé	1
0942601	3308189426015		14	250	35	4	50		15

Tés queue de carpe

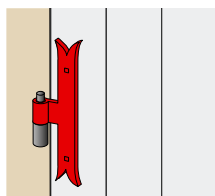
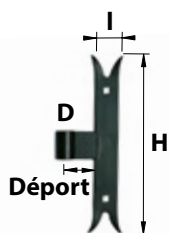

Té bout queue de carpe

Code	Gencod		D	H	I	Ep.	Déport	Type packaging	
0793001	3308180037777		14	250	35	4	50	Vrac gencodé	1

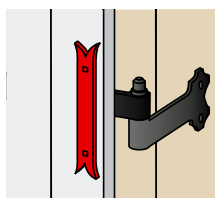

Contre-té bout queue de carpe

Code	Gencod		H	I	Ep.	Type packaging	
0793601	3308180037852		250	35	4	Vrac gencodé	1

Kit penture

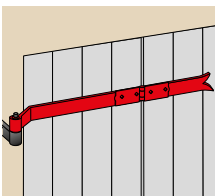
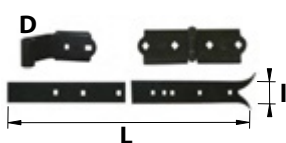

Kit penture spécial volet double

Code	Gencod		D	L	I	Ep.	Type packaging	
0109405	3308181094052		14	1123	35	4	Vrac gencodé	1

Composition

Nœud déporté D14 - Charnière - Eléments de penture recoupables.

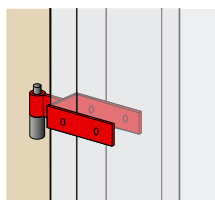
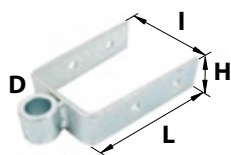

Penture nord U

Code	Gencod		D	L	H	I	Ep.	Type packaging	
M685900	3026726859002	Z.BLANC	14	135	35	80	5	Vrac gencodé	5

Pentures festonnées

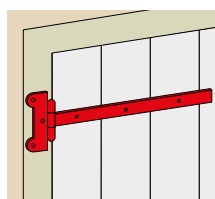

Penture festonnée

Code	Gencod		L	I	Ep.	Type packaging	
629460	3479046294600		300	30	4	Vrac gencodé	5
629465	3479046294655		400	30	4	Vrac gencodé	5
629470	3479046294709		500	30	4	Vrac gencodé	5
629475	3479046294754		600	30	4	Vrac gencodé	5
9629600	3479046296000	Z.BLANC	300	30	4	Vrac gencodé	5
629605	3479046296055	Z.BLANC	400	30	4	Vrac gencodé	5
629610	3479046296109	Z.BLANC	500	30	4	Vrac gencodé	5
629615	3479046296154	Z.BLANC	600	30	4	Vrac gencodé	5

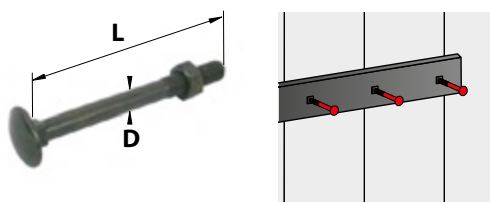

Boulon TRCC

Code	Gencod		D	L	Type packaging	
x8						
629765	3221686297653		6	45	Brochable gencodé	1
629767	3221686297677		6	70	Brochable gencodé	1
0955504	3308189555043		7	45	Brochable gencodé	1
629798	3221686297981		7	60	Brochable gencodé	1
0955604	3308189556040		7	70	Brochable gencodé	1
629793	3221686297936	Z.BLANC	7	45	Brochable gencodé	1
629797	3221686297974	Z.BLANC	7	70	Brochable gencodé	1
x30						
629761	3221686297615		6	45	Brochable gencodé	1
629763	3221686297639		6	70	Brochable gencodé	1
629791	3221686297912		7	45	Brochable gencodé	1
629799	3221686297998		7	60	Brochable gencodé	1
629795	3221686297950		7	70	Brochable gencodé	1

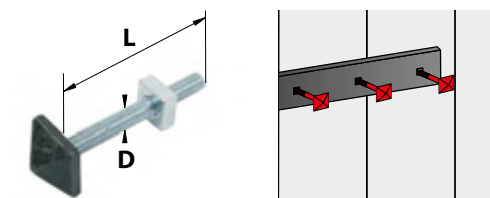

Boulon tête diamant (x4)

Code	Gencod		D	L	Type packaging	
0953401	3308189534017		7	60	Brochable gencodé	1

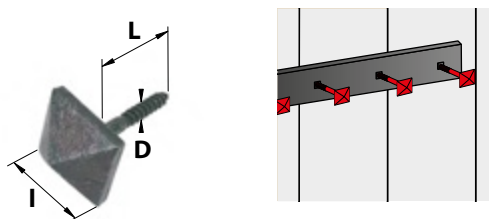

Clou vis tête diamant (x4)

Code	Gencod		D	L	I	Type packaging	
0996600	3308189966009		5	37	15	Brochable gencodé	1
0996700	3308189967006		5	37	25	Brochable gencodé	1

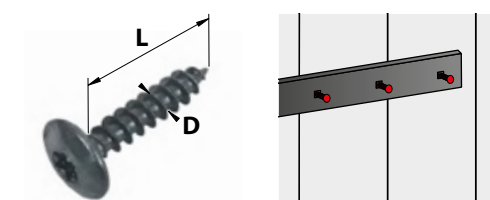

Vis peinture

Code	Gencod		D	L	Type packaging	
x8						
0254201	3308182542019		7	30	Brochable gencodé	1
0254601	3308182546017		7	50	Brochable gencodé	1
x30						
0996900	3308189969000	Z.BLANC	6	30	Brochable gencodé	1
0997000	3308189970006		6	30	Brochable gencodé	1
629780	3221686297806		7	30	Brochable gencodé	1
0996800	3308189968003		7	50	Brochable gencodé	1

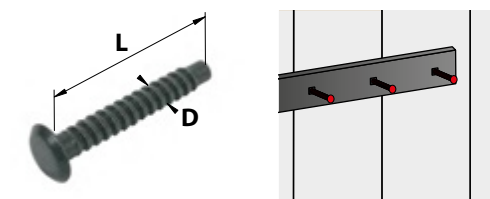

Vis peinture sécurité (x20)

Code	Gencod		D	L	Type packaging	
0953204	3308189532044		7	45	Brochable gencodé	1

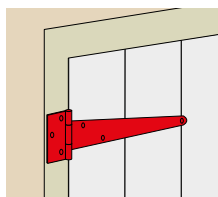
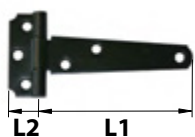

Penture anglaise légère

Code	Gencod		L1	L2	Ep.	Type packaging	
0503401	3308185034016		75	20,5	1,5	Vrac gencodé	10
0503501	3308185035013		100	20,5	1,5	Vrac gencodé	10
0095704	3308180957044		125	20,5	1,5	Vrac gencodé	10
0503402	3308185034023	Z.BLANC	75	20,5	1,5	Vrac gencodé	10
0503502	3308185035020	Z.BLANC	100	20,5	1,5	Vrac gencodé	10
0095702	3308180957020	Z.BLANC	125	20,5	1,5	Vrac gencodé	10
0503602	3308185036027	Z.BLANC	150	43,7	1,5	Vrac gencodé	10
0240802	3308182408025	Z.BLANC	75	20,5	1,5		50
0240902	3308182409022	Z.BLANC	100	20,5	1,5		30
0241002	3308182410028	Z.BLANC	125	20,5	1,5		50
0330302	3308183303022	Z.BLANC	150	43,7	1,5		20

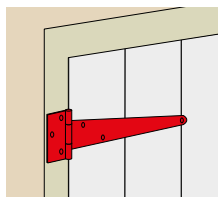
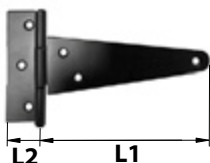

Penture anglaise

Code	Gencod		L1	L2	Ep.	Type packaging	
9624100	3479046241000		80	25	1,5	Vrac gencodé	10
624105	3479046241055		100	25	1,5	Vrac gencodé	10
624110	3479046241109		120	25	1,5	Vrac gencodé	10
624115	3479046241154		150	25	1,5	Vrac gencodé	10
624090	3479046240904	Z.BLANC	80	25	1,5	Vrac gencodé	10
1902102	3479046240911	Z.BLANC	100	25	1,5	Vrac gencodé	10
624092	3479046240928	Z.BLANC	120	25	1,5	Vrac gencodé	10
0330302	3308183303022	Z.BLANC	150	43,7	1,5		20

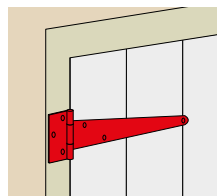

Penture anglaise

Code	Gencod		L1	L2	Ep.	Type packaging	
624155	3479046241550		200	42,7	2	Vrac gencodé	10
624160	3479046241604		250	42,7	2	Vrac gencodé	10
624165	3479046241659		300	42,7	2	Vrac gencodé	10
624170	3479046241703		350	42,7	2	Vrac gencodé	10
624094	3479046240942	Z.BLANC	200	42,7	2	Vrac gencodé	10
624095	3479046240959	Z.BLANC	250	42,7	2	Vrac gencodé	10
624096	3479046240966	Z.BLANC	300	42,7	2	Vrac gencodé	10
624070	3479046240706	Z.BLANC	350	42,7	2	Vrac gencodé	10
0241102	3308182411025	Z.BLANC	200	42,7	2		20
0241202	3308182412022	Z.BLANC	300	42,7	2		30

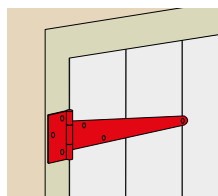

Penture anglaise forte

Code	Gencod		L1	L2	Ep.	Type packaging	
8207015	3221688207018		150	41,7	2,5	Vrac gencodé	10
8207020	3221688207216		200	41,7	2,5	Vrac gencodé	10
8207025	3221688207261		250	41,7	2,5	Vrac gencodé	10
8207030	3221688207315		300	41,7	2,5	Vrac gencodé	10
8207035	3221688207353		350	41,7	2,5	Vrac gencodé	10
8207040	3221688207407		400	41,7	2,5	Vrac gencodé	10
8207050	3221688207506		500	41,7	2,5	Vrac gencodé	10
8207060	3221688207605		600	41,7	2,5	Vrac gencodé	10
7207150	3221687207156		150	41,7	2,5	Vrac gencodé	10
7207200	3221687207200		200	41,7	2,5	Vrac gencodé	10
7207250	3221687207255		250	41,7	2,5	Vrac gencodé	10
7207300	3221687207309		300	41,7	2,5	Vrac gencodé	10
7207350	3221687207354		350	41,7	2,5	Vrac gencodé	10
7207400	3221687207408		400	41,7	2,5	Vrac gencodé	10
7207500	3221687207507		500	41,7	2,5	Vrac gencodé	10
7207600	3221687207606		600	41,7	2,5	Vrac gencodé	10
0465202	3308184652020		400	41,7	2,5		15
0465502	3308184655021		500	41,7	2,5		15
0465602	3308184656028		600	41,7	2,5		15

Penture anglaise avec axe composite

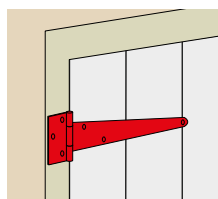
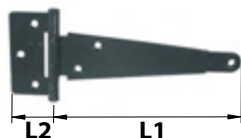

Code	Gencod		L1	L2	Ep.	Type packaging	
756915	3026727569153		144	45	2	Vrac gencodé	5
756920	3026727569207		194	45	2	Vrac gencodé	5
756925	3026727569252		244	45	2	Vrac gencodé	5
757930	3026727579305		292,8	45	2	Vrac gencodé	5
757935	3026727579350		342,8	45	2	Vrac gencodé	5
757940	3026727579404		392,8	45	2	Vrac gencodé	5
757950	3026727579503		492,8	45	2	Vrac gencodé	5
757960	3026727579602		572,8	45	2	Vrac gencodé	5
756815	3026727568156		144	45	2	Vrac gencodé	5
756820	3026727568200		194	45	2	Vrac gencodé	5
756825	3026727568255		244	45	2	Vrac gencodé	5
757830	3026727578308		292,8	45	2	Vrac gencodé	5
757835	3026727578353		342,8	45	2	Vrac gencodé	5
757840	3026727578407		392,8	45	2	Vrac gencodé	5
757850	3026727578506		492,8	45	2	Vrac gencodé	5
757860	3026727578605		572,8	45	2	Vrac gencodé	5

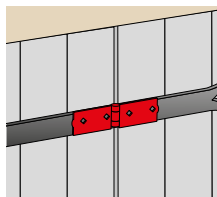
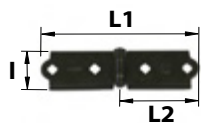

Charnière à penture

Code	Gencod		L1	L2	I	Type packaging	
110040	3221681100408		170	85	35	Vrac gencodé	1
110036	3221681100361		170	85	40	Vrac gencodé	1



Couplet niçois (x2) + visserie

Code	Gencod		H	I	Ep.	Type packaging	
0952501	3308189525015		158	47	2	Brochable gencodé	1

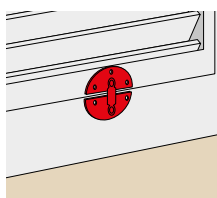
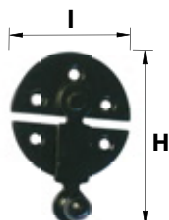

Violet niçois (x2) + visserie

Code	Gencod		H	I	Ep.	Type packaging	
0953101	3308189531016		95	65	2,5	Brochable gencodé	1

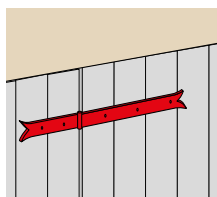

Charnière de jumelage bout queue de carpe

Code	Gencod		L1	L2	I	Ep.	Type packaging	
0742801	3308187428011		400	150	35	4	Vrac gencodé	1
0744601	3308187446015		500	150	35	6	Vrac gencodé	1

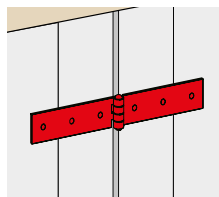
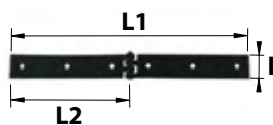

Charnière forte

Code	Gencod		L1	L2	I	Ep.	Type packaging	
0238801	3308182388013		200	100	40	4	Vrac gencodé	10
0238901	3308182389010		300	150	40	4	Vrac gencodé	10
0240001	3308182400012		400	200	40	4	Vrac gencodé	10

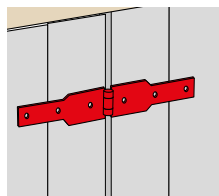
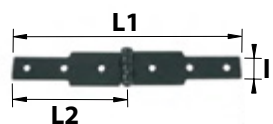

Charnière à congés

Code	Gencod		L1	L2	I	Ep.	Type packaging	
542350	3221685423503		200	100	30	2,5	Vrac gencodé	10
542360	3221685423602		240	120	40	2,5	Vrac gencodé	10
542370	3221685423701		280	140	50	2,5	Vrac gencodé	10
542320	3479045423209	Z.BLANC	200	100	30	2,5	Vrac gencodé	10
542330	3479045423308	Z.BLANC	240	120	40	2,5	Vrac gencodé	10
542340	3479045423407	Z.BLANC	280	140	50	2,5	Vrac gencodé	10
0280403	3308182804032	Z.BLANC	200	100	30	2,5		50
0280503	3308182805039	Z.BLANC	240	120	40	2,5		30
0280903	3308182809037	Z.BLANC	280	140	50	2,5		20

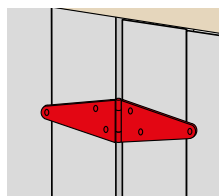

Charnière double axe composite

Code	Gencod		L	I	Ep.	Type packaging	
757970	3026727579701		300	50	2	Vrac gencodé	10
757971	3026727579718		400	50	2	Vrac gencodé	10
757870	3026727578704	Z.BLANC	300	50	2	Vrac gencodé	10
757871	3026727578711	Z.BLANC	400	50	2	Vrac gencodé	10

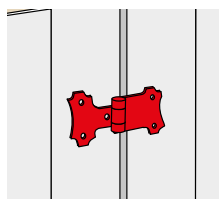
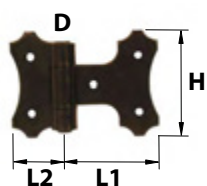

Charnière intermédiaire

Code	Gencod		D	L1	L2	H	Ep.	Type packaging	
0637801	3308186378010		14	83	47	95	4	Vrac gencodé	10

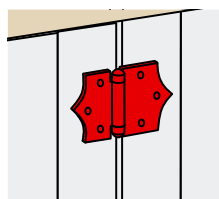
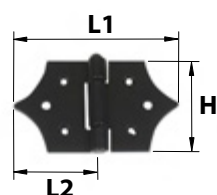

Charnière décorative

Code	Gencod		L1	L2	H	Ep.	Type packaging	
0504701	3308185047016		126	63	74	4	Vrac gencodé	10
0504703	3308185047030	Z.BLANC	126	63	74	4	Vrac gencodé	10
0241401	3308182414019		126	63	74	4		20
0241603	3308182416037	Z.BLANC	126	63	74	4		20
0241803	3308182418031	Z.BLANC	170	85	74	4		20

Gonds à sceller

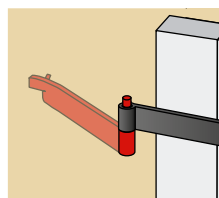
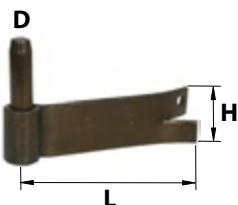

Gond à sceller simple

Code	Gencod		D	L	H	Ep.	Type packaging	
0774801	3308180038040		14	120	35	4	Vrac gencodé	10
0774803	3308180029901	Z.BLANC	14	120	35	4	Vrac gencodé	10

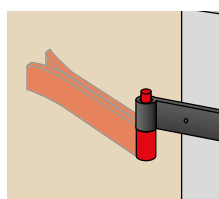
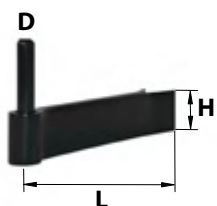

Gond à sceller renforcé

Code	Gencod		D	L	H	Ep.	Type packaging	
0807701	3308180037883		14	130	35	4	Vrac gencodé	10
579014	3479045790141		14	150	35	4	Vrac gencodé	10
0807703	3308180037890	Z.BLANC	14	130	35	4	Vrac gencodé	10
579013	3479045790134	Z.BLANC	14	150	35	4	Vrac gencodé	10
0956701	3308189567015		14	173	40	5	Vrac gencodé	10
735816	3026727358160	Z.BLANC	16	110	35	4	Vrac gencodé	5
0804801	3308180037913		16	130	40	5	Vrac gencodé	10
0525601	3308180038866		16	173	40	5	Vrac gencodé	10
0241301	3308182413012		14	130	35	4		30
0942501	3308189425018		16	130	40	5		30
0418301	3308184183012		16	173	40	5		10

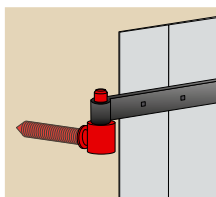
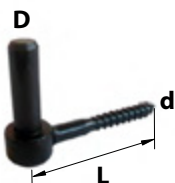

Gond à visser tirefond

Code	Gencod		D	L	d	Type packaging	
0387201	3308183872016		14	90	10	Vrac gencodé	10
0875201	3308188752016		16	90	10	Vrac gencodé	10
0387203	3308183872030	Z.BLANC	14	90	10	Vrac gencodé	10
0875203	3308188752030	Z.BLANC	16	90	10	Vrac gencodé	10
0237901	3308182379011		14	90	10		50
0418601	3308184186013		16	90	10		50
0427001	3308184270019		16	90	10		30

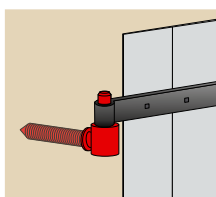
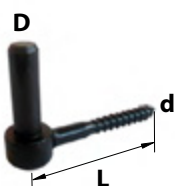

Gond à visser tirefond haut

Code	Gencod		D	L	d	Type packaging	
0350306	3308183503064	DP	14	90	10	Vrac gencodé	10

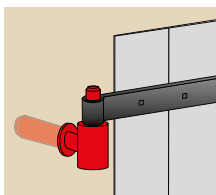

Gond à visser + cheville métal

Code	Gencod		D	L	d	Type packaging	
579152	3479045791520		14	60	M10	Vrac gencodé	5
579161	3479045791612		16	85	M10	Vrac gencodé	5
579151	3479045791513	Z.BLANC	14	60	M10	Vrac gencodé	5
579160	3479045791605	Z.BLANC	16	85	M10	Vrac gencodé	5
0237701	3308182377017		14	60	M10		30

Utiliser le gabarit de perçage (Réf. 0109503 P.163) pour faciliter la pose de votre gond.

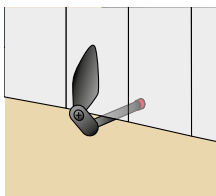

Cheville 4 segments (x2)

Code	Gencod		D	L	d	Type packaging	
0423000	3308184230006	Z.BLANC	10	60	M10	Brochable gencodé	1

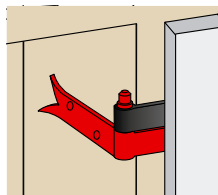
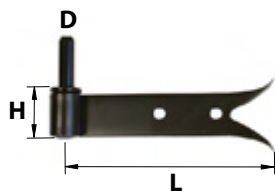

Gond à plaquer bout queue de carpe axe amovible

Code	Gencod		D	L	H	Ep.	Type packaging	
0096401	3308180041293		14	160	35	4	Vrac gencodé	1
739815	3026727398159	Z.BLANC	14	128	30	4	Vrac gencodé	5

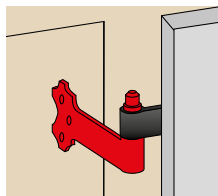
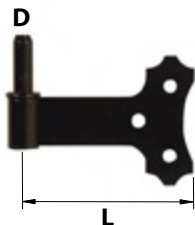

Gond à plaquer axe amovible

Code	Gencod		D	L	Ep.	Type packaging	
0524601	3308185246013		14	125	4	Vrac gencodé	1

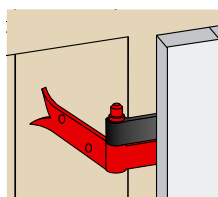
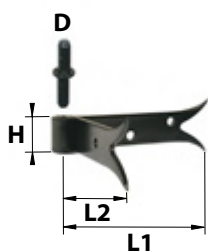

Gond d'angle bout queue de carpe axe amovible

Code	Gencod		D	L1	L2	I	Ep.	Type packaging	
0805401	3308180038637		14	160	130	35	5	Vrac gencodé	1

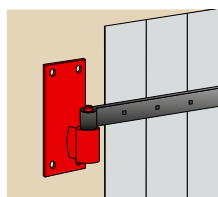
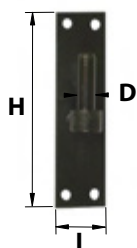

Gond sur platine bout droit

Code	Gencod		D	H	I	Ep.	Type packaging	
0526101	3308185261016		14	120	40	3	Vrac gencodé	5
179302	3221681793020		14	180	40	3	Vrac gencodé	5
0526106	3308185261061	DP	14	120	40	3	Vrac gencodé	5
0526103	3308185261030	Z.BLANC	14	120	40	3	Vrac gencodé	5
179301	3221681793013	Z.BLANC	14	180	40	3	Vrac gencodé	5
179320	3221681793204	Z.BLANC	16	180	40	3	Vrac gencodé	5
0942401	3308189424011		16	120	40	3		20

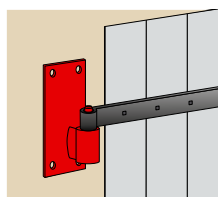
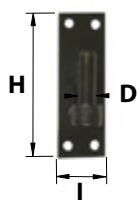

Gond sur platine courte bout droit

Code	Gencod		D	H	I	Ep.	Type packaging	
0526201	3308185262013		16	120	40	3	Vrac gencodé	5
0526203	3308185262037	Z.BLANC	16	120	40	3	Vrac gencodé	5
0257301	3308182573013		14	120	40	3		20

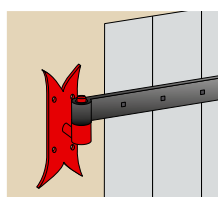
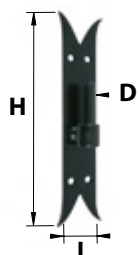

Gond sur platine bout queue de carpe

Code	Gencod		D	H	I	Ep.	Type packaging	
0994301	3308189943017		14	220	40	3	Vrac gencodé	5
0994401	3308189944014		16	220	40	3	Vrac gencodé	5
0994306	3308189943062	DP	14	220	40	3	Vrac gencodé	5
0994302	3308189943024	Z.BLANC	14	220	40	3	Vrac gencodé	5
0242201	3308182422014		14	220	40	3		10

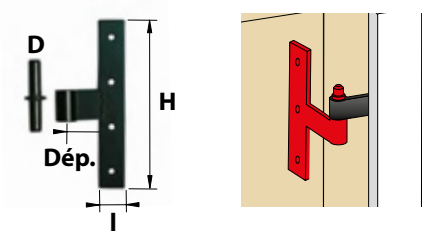

Gond sur té bout droit - Axe amovible

Code	Gencod		D	H	I	Ep.	Déport	Type packaging	
579405	3479045794057		14	190	30	5	35	Vrac gencodé	5

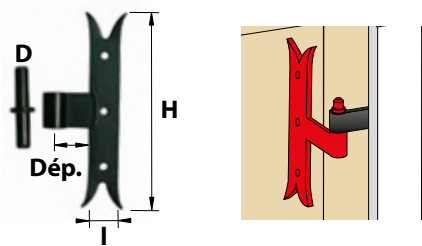

Gond sur té bout queue de carpe - Axe amovible

Code	Gencod		D	H	I	Ep.	Déport	Type packaging	
579401	3479045794019		14	190	30	5	35	Vrac gencodé	5
0964501	3308189645010		14	235	35	4	70	Vrac gencodé	5

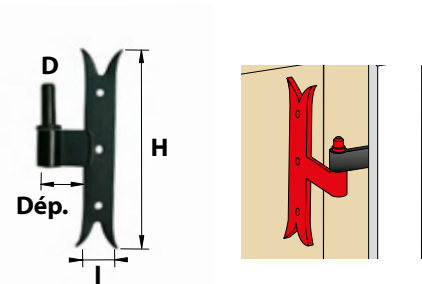

Gond sur té bout queue de carpe

Code	Gencod		D	H	I	Ep.	Déport	Type packaging	
Modèle Droite									
0288101	3308182881019		14	235	35	4	70		10
Modèle Gauche									
0288201	3308182882016		14	235	35	4	70		10

Modèle gauche

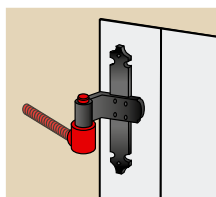
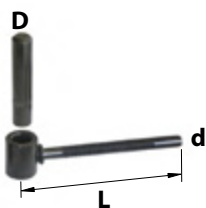

Gond à scellement chimique

Code	Gencod		D	L	d	Type packaging	
0904104	3308189041041		14	85	M10	Vrac gencodé	5
0904204	3308189042048		16	85	M10	Vrac gencodé	5
0904304	3308189043045		14	130	M10	Vrac gencodé	5
0904404	3308189044042		16	130	M10	Vrac gencodé	5
0904103	3308189041034	Z.BLANC	14	85	M10	Vrac gencodé	5
0904303	3308189043038	Z.BLANC	14	130	M10	Vrac gencodé	5
0904403	3308189044035	Z.BLANC	16	130	M10	Vrac gencodé	5
0260801	3308182608012		14	85	M10		30
0241901	3308182419014		14	130	M10		30
0418404	3308184184040		16	130	M10		30

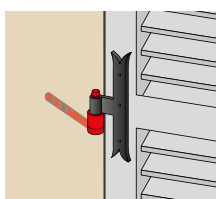
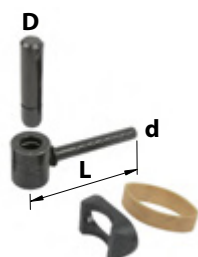

Polygond à clips renforcé fer à béton

Code	Gencod		D	L	d	Type packaging	
0980001	3308189800013		14	70	M10	Vrac gencodé	5
0980101	3308189801010		14	115	M10	Vrac gencodé	5

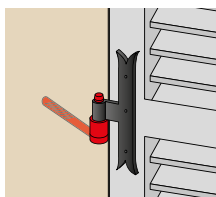

Polygond à clips

Code	Gencod		D	L	d	Type packaging	
0273901	3308182739013		14	70	M10	Vrac gencodé	5
0274001	3308182740019		16	70	M10	Vrac gencodé	5
0980301	3308189803014		14	130	M10	Vrac gencodé	5
0980401	3308189804011		16	130	M10	Vrac gencodé	5

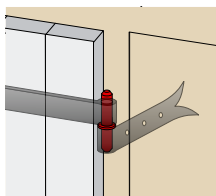
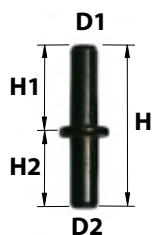

Axe de gond amovible

Code	Gencod		D1	D2	H	H1	H2	Type packaging	
0221904	3308182219041		14	14	80	42	35	Vrac gencodé	10
0900901	3308189009010		14	16	84	35	45	Vrac gencodé	10

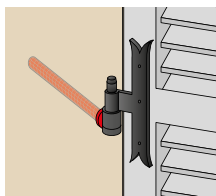
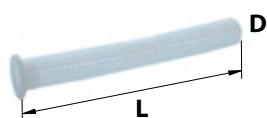

Tamis composite (x4)

Code	Gencod		D	L	Type packaging	
0456000	3308184560004		16	80	Vrac gencodé	5
0455900	3308184559008		16	130	Vrac gencodé	5

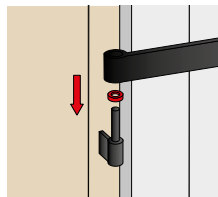
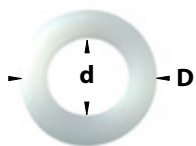

Rondelle composite (x10)

Code	Gencod		d	D	Ep.	Type packaging		
0952000	3308189520003		<input type="text"/>	14	25	3	Brochable gencodé	1
0952100	3308189521000		<input type="text"/>	16	27	3	Brochable gencodé	1
0418100	3308184181001		<input type="text"/>	14	25	3		30

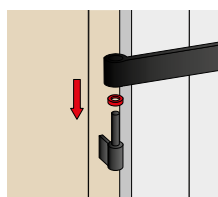
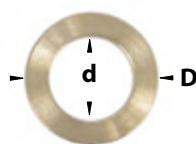

Rondelle laiton (x4)

Code	Gencod		d	D	Ep.	Type packaging		
0953900	3308189539005	LAITON	<input type="text"/>	14	25	3	Brochable gencodé	1
0954000	3308189540001	LAITON	<input type="text"/>	16	27	3	Brochable gencodé	1

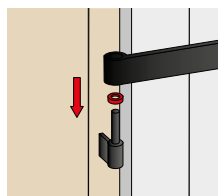
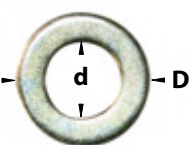

Rondelle acier (x4)

Code	Gencod		d	D	Ep.	Type packaging		
0953703	3308189537032	Z.BLANC	<input type="text"/>	14	25	3	Brochable gencodé	1
0953803	3308189538039	Z.BLANC	<input type="text"/>	16	27	3	Brochable gencodé	1

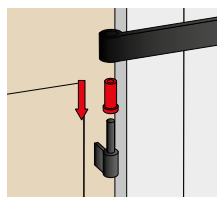

Convertisseur gond

Code	Gencod		d	D	L	Type packaging	
x2							
0953600	3308189536004		12	14	40,5	Brochable gencodé	1
0953500	3308189535007		14	16	40,5	Brochable gencodé	1
x4							
0418000	3308184180004		14	16	40,5		15

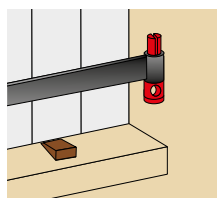

Gabarit de perçage pour gond à scellement chimique

Code	Gencod		Type packaging	
0963400	3308189634007		Brochable gencodé	1

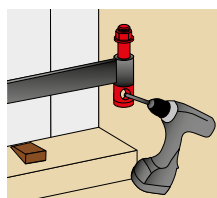

Gabarit de perçage acier pour gond à scellement chimique

Code	Gencod		Type packaging	
0109503	3308181095035	Z.BLANC	Brochable gencodé	1

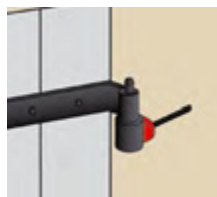

Bague de propreté pour gond

Code	Gencod		Type packaging	
0960000	3308189600002		Sachet gencodé	5
0959900	3308189599009		Sachet gencodé	5



La mise en œuvre des fermetures est encadrée par le DTU 34-4, s'y référer pour éviter tout danger.

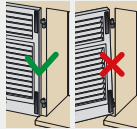

Bien s'assurer que le vantail soit monté plaqué et serré sur la façade.



En cas de vent, fermer les volets.



Pour les volets de grandes tailles, utiliser uniquement les arrêts adaptés



Conseils de pose P.133



Plus d'infos sur www.afbat.com

Tourniquet marseillais à vis bois *

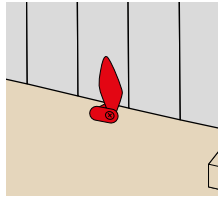
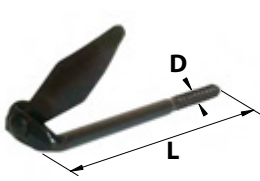

Code	Gencod		D	L	Type packaging	
0281201	3308182812013		10	110	Vrac gencodé	5
0222901	3308182229019		10	130	Vrac gencodé	5
0281301	3308182813010		10	180	Vrac gencodé	5
0417501	3308184175017		10	250	Vrac gencodé	1
0281203	3308182812037	Z.BLANC	10	110	Vrac gencodé	5
0222903	3308182229033	Z.BLANC	10	130	Vrac gencodé	5
0281303	3308182813034	Z.BLANC	10	180	Vrac gencodé	5
0249001	3308182490013		10	110		50
0426701	3308184267019		10	180		20
0425901	3308184259014		10	130		30
0426701	3308184267019		10	180		20
0426001	3308184260010		10	110		30

Tourniquet marseillais à vis + cheville *

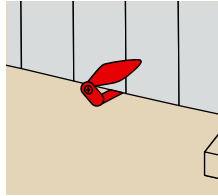

Code	Gencod		D	L	Type packaging	
0442304	3308184423040		8	115	Vrac gencodé	5
0442303	3308184423033	Z.BLANC	10	115	Vrac gencodé	5
0249301	3308182493014		8	115		30

Tourniquet marseillais sur platine à visser *

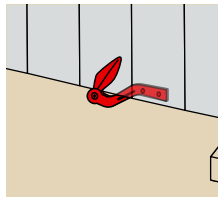
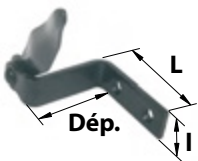

Code	Gencod		L	I	Ep.	Déport	Type packaging	
0238001	3308182380017		50	20	3,5	47	Vrac gencodé	5
0238003	3308182380031	Z.BLANC	50	20	3,5	47	Vrac gencodé	5

Arrêts de volet sur platine

(*)



La mise en œuvre des fermetures est encadrée par le DTU 34-4, s'y référer pour éviter tout danger.

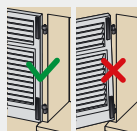

Bien s'assurer que le vantail soit monté plaqué et serré sur la façade.



En cas de vent, fermer les volets.



Pour les volets de grandes tailles, utiliser uniquement les arrêts adaptés



Conseils de pose P.133



Plus d'infos sur www.afbat.com



Dép.

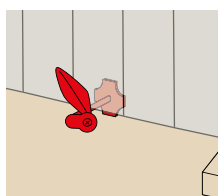

Tourniquet marseillais sur platine à visser *

Code	Gencod		Déport	Type packaging	
520350	3479045203504		40	Vrac gencodé	5
520355	3479045203559		70	Vrac gencodé	5

Arrêts de volet à sceller

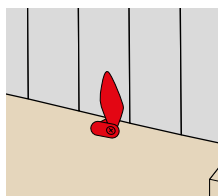
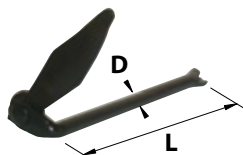

Tourniquet marseillais à sceller *

Code	Gencod		D	L	Type packaging	
0804601	3308188046016		10	130	Vrac gencodé	5
0804701	3308188047013		10	175	Vrac gencodé	5
0804603	3308180038163	Z.BLANC	10	130	Vrac gencodé	5
0804703	3308180038712	Z.BLANC	10	175	Vrac gencodé	5

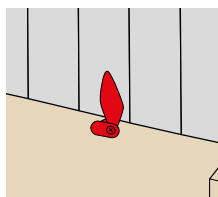
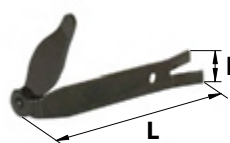

Tourniquet marseillais plat à sceller *

Code	Gencod		L	I	Ep.	Type packaging	
0248601	3308182486016		125	20	3,5		30



La mise en œuvre des fermetures est encadrée par le DTU 34-4, s'y référer pour éviter tout danger.

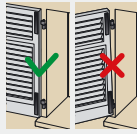

Bien s'assurer que le vantail soit monté plaqué et serré sur la façade.



En cas de vent, fermer les volets.



Pour les volets de grandes tailles, utiliser uniquement les arrêts adaptés



Conseils de pose P.133



Plus d'infos sur www.afbat.com

Arrêt tête bergère à visser *

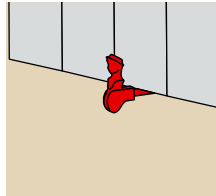
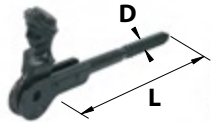

Code	Gencod		D	L	Type packaging	
0724001	3308187240019		10	115	Vrac gencodé	5
0724701	3308187247018		10	155	Vrac gencodé	5
0249501	3308182495018		10	115		50
0259801	3308182598016		10	155		20

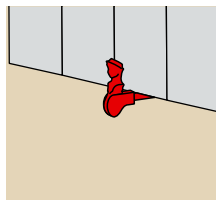
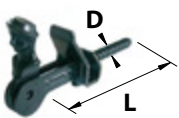

Arrêt tête bergère à visser + butée *

Code	Gencod		D	L	Type packaging	
0724901	3308187249012		10	115	Vrac gencodé	5

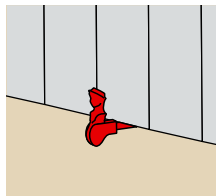

Arrêt tête bergère sur platine à visser *

Code	Gencod		Déport	Type packaging	
0900701	3308189007016		35	Vrac gencodé	5

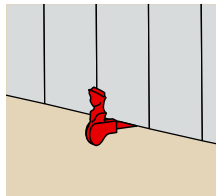
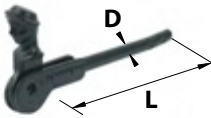

Arrêt tête bergère à sceller *

Code	Gencod		D	L	Type packaging	
0723901	3308187239013		10	135	Vrac gencodé	5

Butées d'arrêts de volet

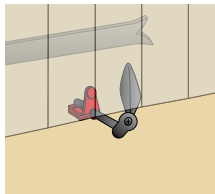
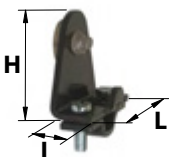

Butée universelle pour tourniquet marseillais

Code	Gencod		L	I	H	Ep.	Type packaging	
Sachet 2 unités								
0956501	3308189565011		41	17,5	41	2,5	Brochable gencodé	2
Sachet unitaire								
0198704	3308181987040		38	17,5	39	2,5	Vrac gencodé	1
0198703	3308180038873	Z.BLANC	38	17,5	39	2,5	Vrac gencodé	1
0432304	3308184323043		41	17,5	41	2,5		50

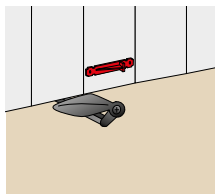

Protecteur de volet composite (x2)

Code	Gencod		L	I	H	Type packaging	
0953000	3308189530002		70	15	12	Brochable gencodé	1

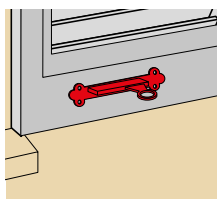

Arrêt de volet à ressort autobloquant

Code	Gencod		L	I	H	Ep.	Type packaging		
0954801	3308189548014		148	38	50	2	Brochable gencodé		1
0941501	3308189415019		148	38	50	2			10



La mise en œuvre des fermetures est encadrée par le DTU 34-4, s'y référer pour éviter tout danger.

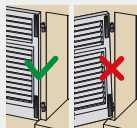

Bien s'assurer que le vantail soit monté plaqué et serré sur la façade.



En cas de vent, fermer les volets.



Pour les volets de grandes tailles, utiliser uniquement les arrêts adaptés



Conseils de pose P.133



Plus d'infos sur www.afbat.com

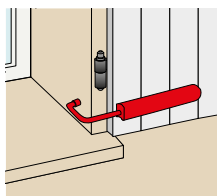
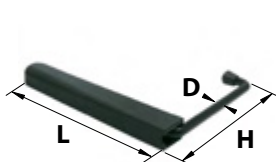

Arrêt de volet Verouilvolet (x2)

Code	Gencod		D	L	H	Type packaging		
0952400	3308189524001		12	250	135	Brochable gencodé		1
0958500	3308189585002		12	250	135	Brochable gencodé		1



La mise en œuvre des fermetures est encadrée par le DTU 34-4, s'y référer pour éviter tout danger.



Surface maximum 1 m² par vantail.

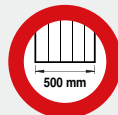

Largeur maximum du volet : 500 mm.



Ne pas utiliser en zone venteuse.



En cas de vent, fermer les volets.



Utiliser tous les trous de fixation prévus à cet effet (5) pour fixer la pièce.



Vérifier le serrage régulièrement.



Conseils de pose P.133



Plus d'infos sur www.afbat.com

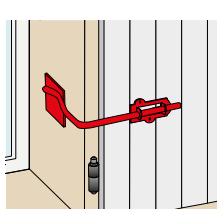
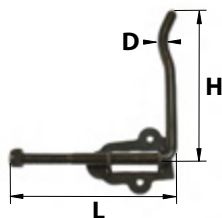

Arrêt de volet à poignée (x2)

Code	Gencod		D	L	H	Type packaging		
0956704	3308189567046		12	167	174	Brochable gencodé		1
0956626	3308189566261		12	167	174	Brochable gencodé		1
0932601	3308189326018		12	167	174			4



La mise en œuvre des fermetures est encadrée par le DTU 34-4, s'y référer pour éviter tout danger.



Surface maximum 1 m² par vantail.

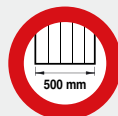

Largeur maximum du volet : 500 mm.



Ne pas utiliser en zone venteuse.



En cas de vent, fermer les volets.



Utiliser tous les trous de fixation prévus à cet effet (2+2) pour fixer la pièce.



Vérifier le serrage régulièrement.



Conseils de pose P.133



Plus d'infos sur www.afbat.com

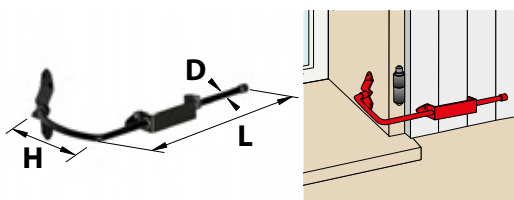

Arrêt de volet Bloc Boy

Code	Gencod		D	L	H	Type packaging	
0994800	3308189948005		14	414	188	Brochable gencodé	1
0994900	3308189949002		14	414	188	Brochable gencodé	1



La mise en œuvre des fermetures est encadrée par le DTU 34-4, s'y référer pour éviter tout danger.



Surface maximum 1,5 m² par vantail.



Poids maximum 20 kg par vantail



Ne pas utiliser en zone venteuse.



En cas de vent, fermer les volets.



Utiliser tous les trous de fixation prévus à cet effet (4+4) pour fixer la pièce.



Vérifier le serrage régulièrement.



Conseils de pose P.133



Plus d'infos sur www.afbat.com

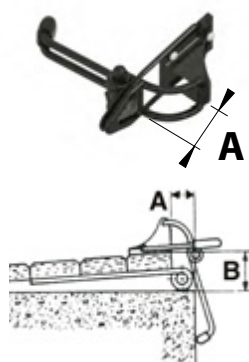

Arrêt BlocVolet

Code	Gencod		A	B	Type packaging	
152060	3332061520607		<ou= 3 cm	<ou= 9 cm	Brochable gencodé	1



La mise en œuvre des fermetures est encadrée par le DTU 34-4, s'y référer pour éviter tout danger.



Surface maximum 1 m² par vantail.



Poids maximum 20 kg par vantail



Ne pas utiliser en zone venteuse.



En cas de vent, fermer les volets.



Utiliser tous les trous de fixation prévus à cet effet (3) pour fixer la pièce.



Vérifier le serrage régulièrement.



Conseils de pose P.133



Plus d'infos sur www.afbat.com

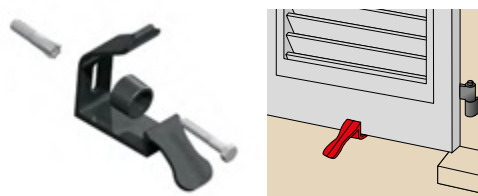

Arrêt StopVolet (x 2)

Code	Gencod		Type packaging	
Epaisseur de volet de 20 à 35 mm				
151050	3332061510509		Vrac gencodé	10
621430	3332061511308		Vrac gencodé	10



La mise en œuvre des fermetures est encadrée par le DTU 34-4, s'y référer pour éviter tout danger.

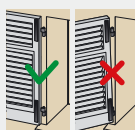

Bien s'assurer que le vantail soit monté plaqué et serré sur la façade.



En cas de vent, fermer les volets.



Pour les volets de grandes tailles, utiliser uniquement les arrêts adaptés



Conseils de pose P.133



Plus d'infos sur www.afbat.com

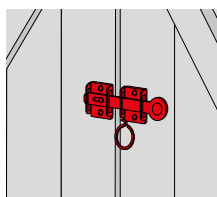
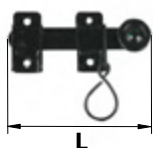

Fermeture de volet + support

Code	Gencod		L	Type packaging	
0273201	3308182732014		130	Vrac gencodé	5
0941901	3308189419017		130		20

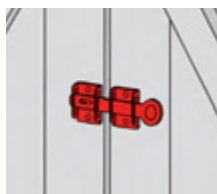

Poignée fléau à blocage + support

Code	Gencod		L	Type packaging	
529202	3479045292027		160	Vrac gencodé	5
529183	3479045291839	Z.BLANC	160	Vrac gencodé	5
9529203	3479045292034		190	Vrac gencodé	5
529181	3479045291815	Z.BLANC	190	Vrac gencodé	5

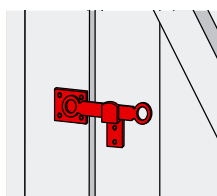
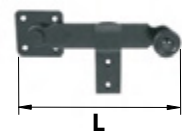

Poignée fléau + support

Code	Gencod		L	Type packaging	
0812701	3308188127012		140	Vrac gencodé	10
0812901	3308188129016		160	Vrac gencodé	10
0813001	3308188130012		190	Vrac gencodé	10
0812703	3308180038552	Z.BLANC	140	Vrac gencodé	10
0812903	3308180038569	Z.BLANC	160	Vrac gencodé	10
0813003	3308180038576	Z.BLANC	190	Vrac gencodé	10
0941801	3308189418010		140		20
0246302	3308182463024	Z.BLANC	140		20
0246402	3308182464021	Z.BLANC	190		20

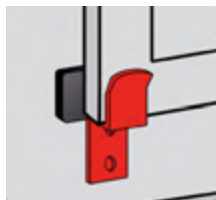
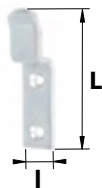

Agrafe volet nord coudée

Code	Gencod		L	I	Ep.	Type packaging	
6104009	3221686104005	Z.BLANC	75	18	3	Vrac gencodé	5

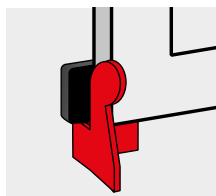

Modèle droite

Agrafe picarde coudée

Code	Gencod		L	I	Ep.	Type packaging	
Modèle droite							
6106134	3221686106139	Z.BLANC	35	18	3	Vrac gencodé	5
Modèle gauche							
6106234	3221686106238	Z.BLANC	35	18	3	Vrac gencodé	5

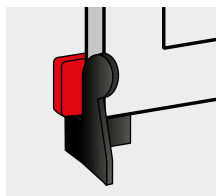

Panneton droit

Code	Gencod		L	I	Ep.	Type packaging	
6103075	3221686103077	Z.BLANC	75	18	3	Vrac gencodé	5

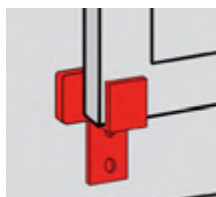

Panneton + agrafe

Code	Gencod		Type packaging	
Panneton + agrafe nord coudée (x4)				
0544175	3221680544173		Vrac gencodé	1
0144175	3221680144175	Z.BLANC	Vrac gencodé	1
Panneton + agrafe picarde (2 droite + 2 gauche)				
0953302	3308189533027	Z.BLANC	Brochable gencodé	1

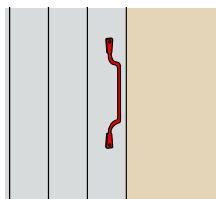
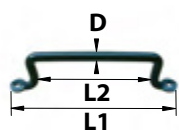

Poignée fil à pattes

Code	Gencod		D	L1	L2	Type packaging	
9158085	3221689158081		8	140	85	Vrac gencodé	10
0357804	3308183578048		8	165	95	Vrac gencodé	10
0502104	3308185021047		10	160	105	Vrac gencodé	10
7158085	3221687158083	Z.BLANC	8	140	85	Vrac gencodé	10
6158100	3221686158107	Z.BLANC	8	165	95	Vrac gencodé	10
0502102	3308185021023	Z.BLANC	10	160	105	Vrac gencodé	10
0258201	3308182582015		8	165	95		50
0258202	3308182582022	Z.BLANC	8	165	95		50

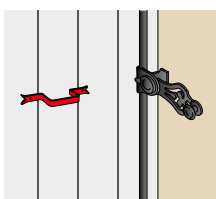
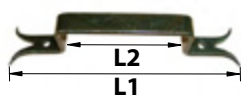

Poignée à pattes queue de carpe

Code	Gencod		L1	L2	Type packaging	
9115085	3221689115084		175	85	Vrac gencodé	10

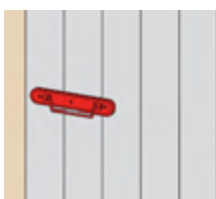

Poignée sur platine bouts ronds

Code	Gencod		L	Type packaging	
8149014	3221688149141		140	Vrac gencodé	10
8149016	3221688149165		160	Vrac gencodé	10
8149019	3221688149196		190	Vrac gencodé	10
6149014	3221686149143	Z.BLANC	140	Vrac gencodé	10
6149016	3221686149167	Z.BLANC	160	Vrac gencodé	10
6149019	3221686149198	Z.BLANC	190	Vrac gencodé	10

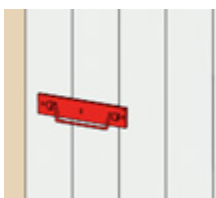

Poignée sur platine bouts carrés

Code	Gencod		L	Type packaging	
8150012	3221688150123		120	Vrac gencodé	10
8150014	3221688150147		140	Vrac gencodé	10
8150016	3221688150161		160	Vrac gencodé	10
8150019	3221688150192		190	Vrac gencodé	10
0491303	3308184913039	Z.BLANC	120	Vrac gencodé	10
0724103	3308187241030	Z.BLANC	140	Vrac gencodé	10
7150016	3221687150162	Z.BLANC	160	Vrac gencodé	10
7150019	3221687150193	Z.BLANC	190	Vrac gencodé	10
0246504	3308182465042		140		30
0246503	3308182465035	Z.BLANC	140		30

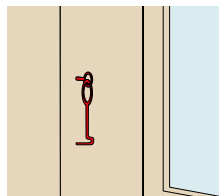
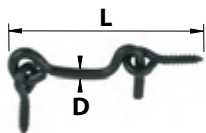

Crochet de contrevent + pitons

Code	Gencod		D	L	Type packaging	
8177005	3221688177007		4	50	Vrac gencodé	10
8177060	3221688177069		4	60	Vrac gencodé	10
8177080	3221688177083		4	80	Vrac gencodé	10
6177005	3221686177009	Z.BLANC	4	50	Vrac gencodé	10
6177060	3221686177061	Z.BLANC	4	60	Vrac gencodé	10
6177080	3221686177085	Z.BLANC	4	80	Vrac gencodé	10
8177100	3221688177106		5	100	Vrac gencodé	10
8177120	3221688177120		5	120	Vrac gencodé	10
6177100	3221686177108	Z.BLANC	5	100	Vrac gencodé	10
6177120	3221686177122	Z.BLANC	5	120	Vrac gencodé	10
8177140	3221688177144		6	140	Vrac gencodé	10
8177160	3221688177168		6	160	Vrac gencodé	10
8177180	3221688177182		6	180	Vrac gencodé	10
8177200	3221688177205		6	200	Vrac gencodé	10
6177140	3221686177146	Z.BLANC	6	140	Vrac gencodé	10
6177160	3221686177160	Z.BLANC	6	160	Vrac gencodé	10
6177180	3221686177184	Z.BLANC	6	180	Vrac gencodé	10
6177200	3221686177207	Z.BLANC	6	200	Vrac gencodé	10
0494804	3308184948048		8	300	Vrac gencodé	10
0494904	3308184949045		8	400	Vrac gencodé	10
0495004	3308184950041		8	500	Vrac gencodé	10
0494802	3308184948024	Z.BLANC	8	300	Vrac gencodé	10
0494902	3308184949021	Z.BLANC	8	400	Vrac gencodé	10
0495002	3308184950027	Z.BLANC	8	500	Vrac gencodé	10
0245402	3308182454022	Z.BLANC	4	50		100
0245502	3308182455029	Z.BLANC	4	80		100
0245602	3308182456026	Z.BLANC	5	100		100
0245702	3308182457023	Z.BLANC	5	120		50
0245802	3308182458020	Z.BLANC	6	140		50
0245902	3308182459027	Z.BLANC	6	160		50
0246002	3308182460023	Z.BLANC	6	180		50
0246102	3308182461020	Z.BLANC	6	200		50
Sachet de 2 unités						
672305	3026726723051	Z.BLANC	8	60	Vrac gencodé	
672308	3026726723082	Z.BLANC	8	80	Vrac gencodé	
672310	3026726723105	Z.BLANC	8	100	Vrac gencodé	
672314	3026726723143	Z.BLANC	8	140	Vrac gencodé	
672316	3026726723167	Z.BLANC	8	160	Vrac gencodé	

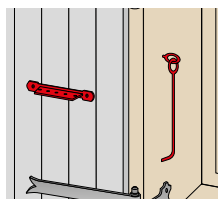
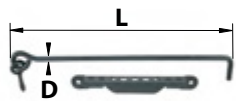

Crochet + crémaillère à poignée

Code	Gencod		D	L	Type packaging	
0491104	3308180038897		8	300	Vrac gencodé	10
503496	3479045034962		8	350	Vrac gencodé	10
0491004	3308180038910		8	400	Vrac gencodé	10
0812404	3308180038521		8	500	Vrac gencodé	10
503500	3479045035006		8	600	Vrac gencodé	10
0491103	3308184911035	Z.BLANC	8	300	Vrac gencodé	10
503476	3479045034764	Z.BLANC	8	350	Vrac gencodé	10
0491003	3308184910038	Z.BLANC	8	400	Vrac gencodé	10
0812403	3308180038514	Z.BLANC	8	500	Vrac gencodé	10
503480	3479045034801	Z.BLANC	8	600	Vrac gencodé	10
0464604	3308184646043		8	300		40
0465004	3308184650040		8	400		25

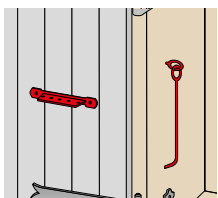
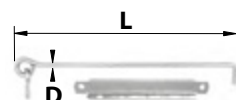

Crochet + crémaillère L

Code	Gencod		D	L	Type packaging	
0288002	3308182880029	Z.BLANC	8	300		20
0466102	3308184661022	Z.BLANC	8	400		20
0466202	3308184662029	Z.BLANC	8	500		20

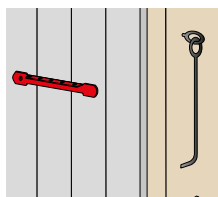
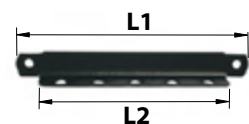

Crémaillère L

Code	Gencod		L1	L2	Ep.	Type packaging	
0362501	3308183625018		190	155	2	Vrac gencodé	1

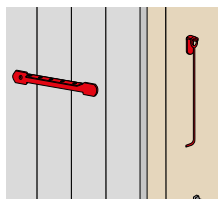
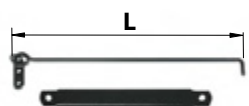

Crochet sur platine + crémaillère L

Code	Gencod		D	L	Type packaging	
0963001	3308189630016		8	300	Vrac gencodé	5
0963101	3308189631013		8	400	Vrac gencodé	5

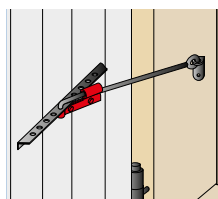
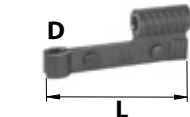

Verrou antisoulèvement pour crochet de volet

Code	Gencod		D	L	Type packaging	
0958200	3308189582001		10	97	Brochable gencodé	1

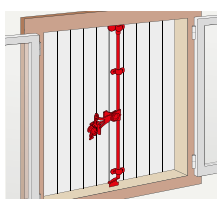
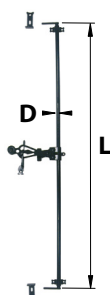
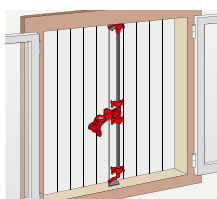
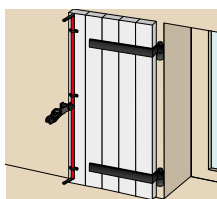
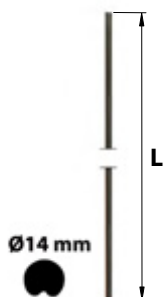
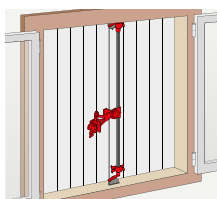
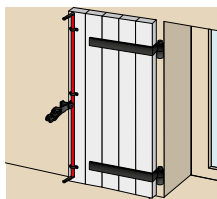
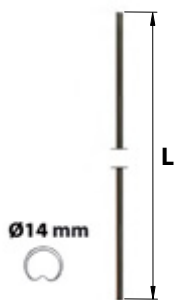

Tube rainuré pour espagnolette acier

Code	Gencod		D	L	Type packaging	
0262101	3308182621011		14	1270	Vrac gencodé	1
0706800	3308187068002		14	1570	Vrac gencodé	1

Accessoires espagnolette ronde rainurée

Code	Gencod		Type packaging	
1 Support antisoulèvement				
0954401	3308189544016		Brochable gencodé	1
2 Support standard				
0954301	3308189543019		Brochable gencodé	1
0941601	3308189416016			10

Composition

1 poignée + 1 boulon 2 crochets droits
 2 lacets rustiques + 1 lacet fil rond 1 support antisoulèvement 1 ou 1 support standard 2

Tringle rainurée pleine Provence

Code	Gencod		D	L	Type packaging	
0980501	3308189805018		14	1500	Vrac gencodé	1
0980601	3308189806015		14	2000	Vrac gencodé	1
0980701	3308189807012		14	2500	Vrac gencodé	1

Sachet d'accessoires Provence

Code	Gencod		Type packaging	
Crochets droits - Support de sécurité - Lacets rustiques - Dardennes coudées				
07PNC3B14	3700093126584		Vrac gencodé	10
Crochets droits - Support de sécurité - Lacets déportés - Dardennes coudées				
0981201	3700093126591		Vrac gencodé	10
Crochets droits - Support - Lacets rustiques - Dardennes coudées				
0983201	3700093126539		Vrac gencodé	10
Crochets droits - Support - Lacets déportés - Dardennes coudées				
0983301	3700093126546		Vrac gencodé	1

Kit complet espagnolette ronde pleine

Code	Gencod		D	L	Type packaging	
0703404	3308187034045		14	1500	Vrac gencodé	1
0703504	3308187035042		14	2400	Vrac gencodé	1

Composition

1 poignée + 1 boulon 3 lacets à patte rustique + 1 lacet fil rond
 1 support antisoulèvement 1 support antisoulèvement
 1 tringle, 2 crochets soudés 2 butées

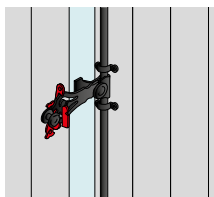

Support espagnolette antisoulèvement

Code	Gencod		Type packaging	
0957801	3308189578011		Brochable gencodé	1

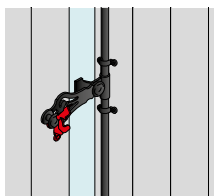

Support espagnolette verrou

Code	Gencod		Type packaging	
0957904	3308189579049		Brochable gencodé	1

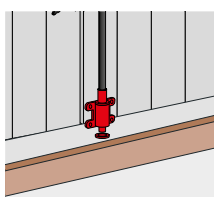

Modèle bas

Verrou espagnolette

Code	Gencod		Type packaging	
Modèle Bas				
0958300	3308189583008		Brochable gencodé	1
Modèle Haut				
0964800	3308189648004		Brochable gencodé	1

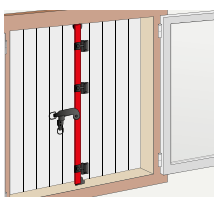
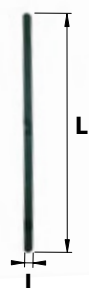

Tringle pour espagnolette plate acier

Code	Gencod		L	I	Ep.	Type packaging	
620651	3479046206511		1500	25	4	Vrac gencodé	1
620653	3479046206535		2500	25	4	Vrac gencodé	1

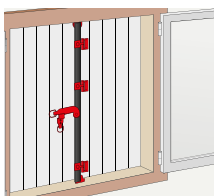

Accessoires espagnolette plate acier

Code	Gencod		Type packaging	
620632	3221686206327		Brochable gencodé	1

Composition
3 coulisseaux
1 support de loquet

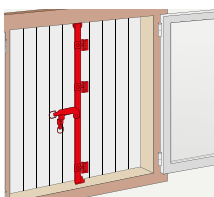

Kit complet espagnolette plate

Code	Gencod		L	I	Ep.	Type packaging	
0703204	3308187032041		1500	25	4	Vrac gencodé	1
0703304	3308187033048		2400	25	4	Vrac gencodé	1

Composition
1 tringle plate L1500 ou 2400 mm
1 butée haute + 1 butée basse
3 coulisseaux
1 support de loquet

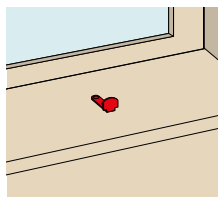
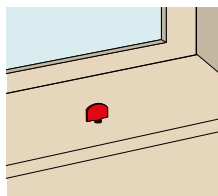
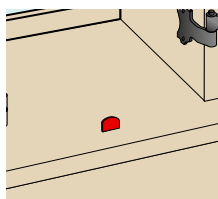
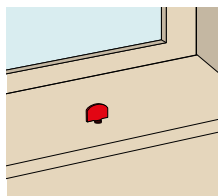
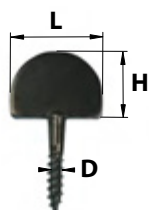

Butée droite à vis

Code	Gencod		D	L	H	Ep.	Type packaging	
9251001	3221689251010		6	57	25	3,5	Vrac gencodé	10
7251001	3221687251005	Z.BLANC	6	57	25	3,5	Vrac gencodé	10
0244301	3308182443019		6	57	25	3,5		100
x2								
0988001	3308189880015		6	57	25	3,5	Vrac gencodé	5
Butée droite à vis + à cheville (x2)								
0269401	3308182694015		6	57	25	3,5	Brochable gencodé	1

Butée coudée à vis

Code	Gencod		D	L	H	Ep.	Déport	Type packaging	
0544404	3308185444044		6	37	27	3	36	Vrac gencodé	10
0988201	3308189882019		6	37	27	3	36	Vrac gencodé	5
7351011	3221687351019	Z.BLANC	6	37	27	3	36	Vrac gencodé	10
0244101	3308182441015		6	37	27	3	36		100

Kit butée à vis 1 droite + 1 coudée + 2 chevilles

Code	Gencod		Type packaging	
538055	3221685380554		Brochable gencodé	10

Butée coudée ronde à visser

Code	Gencod		H	Ep.	Déport	Type packaging	
9351600	3221689351604		25	3	30	Vrac gencodé	10
7351600	3221687351606	Z.BLANC	25	3	30	Vrac gencodé	10

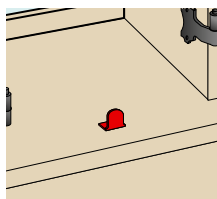
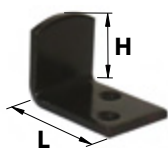

Butée coudée à visser

Code	Gencod		L	H	Ep.	Type packaging	
4239034	3221684139030		44	25	4	Vrac gencodé	10
7239034	3221687239034	Z.BLANC	44	25	4	Vrac gencodé	10

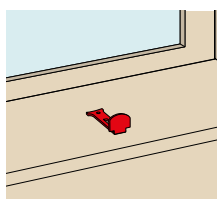
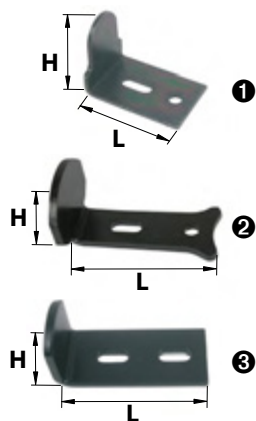

Butée coudée réglable à visser

Code	Gencod		L	H	Ep.	Type packaging		
1 trou rond + 1 trou oblong								
①	620099	3479046200991		47	35	2,5	Vrac gencodé	10
②	602040	3221686020404		63	35	3	Vrac gencodé	10
②	0942904	3308189429047		63	35	3		50
2 trous oblongs								
③	4172034	3221684172037		69	30	4	Vrac gencodé	10
③	7172034	3221687172034	Z.BLANC	69	30	4	Vrac gencodé	10

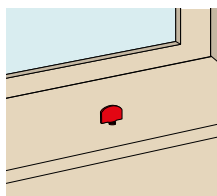

Butée droite à sceller

Code	Gencod		L	H	Ep.	Type packaging	
0408404	3308184084043		60	25	4	Vrac gencodé	10
0408403	3308184084036	Z.BLANC	60	25	4	Vrac gencodé	10

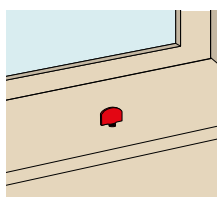

Butée coudée à sceller

Code	Gencod		H	Ep.	Déport	Type packaging	
9151011	3221689151013		25	3	32	Vrac gencodé	10

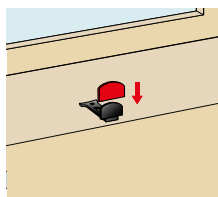
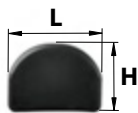

Protecteur tête de butée composite (x2)

Code	Gencod		L	H	Type packaging	
0952900	3308189529006		43	33	Brochable gencodé	1

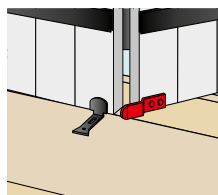
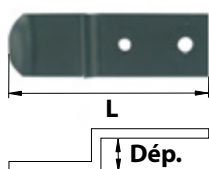

Crochet de rappel (x2)

Code	Gencod		L	Ep.	Déport	Type packaging	
0952604	3308189526043		70	2,5	10	Brochable gencodé	1
0261501	3308182615010		70	2,5	10		20

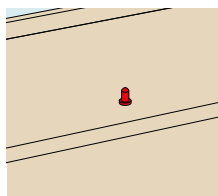

Goujon espagnolette

Code	Gencod		ØD	Ød	H	Type packaging	
Droit à visser							
0963701	3308189637015		10	7	65	Vrac gencodé	1
Droit à visser (x2) + chevilles (x2)							
0269601	3308182696019		10	7	65	Brochable gencodé	1
Goujon droit (x1) + coudé (x1) + chevilles (x2)							
620093	3221686200936		10	7	65	Brochable gencodé	1

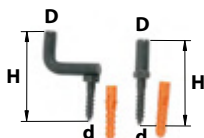



L'EXTÉRIEUR DE L'HABITAT

LE VOLET ALU & PVC

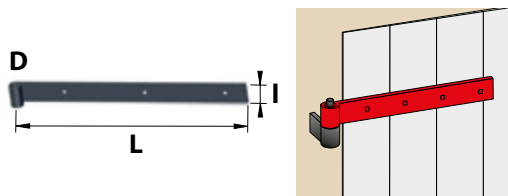

Penture aluminium bout droit

Code	Gencod		D	L	I	Ep.	Type packaging	
1401415	3308181401416		14	415	39	4	Vrac gencodé	4
1401560	3308181401560		14	560	39	4	Vrac gencodé	4

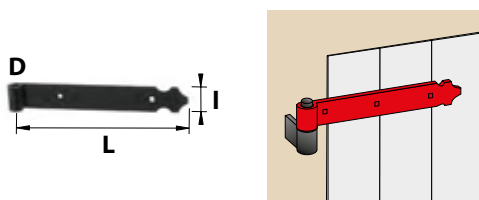

Penture aluminium bout feston

Code	Gencod		D	L	I	Ep.	Type packaging	
1403415	3308181403410		14	415	39	4	Vrac gencodé	4
1403560	3308181403564		14	560	39	4	Vrac gencodé	4

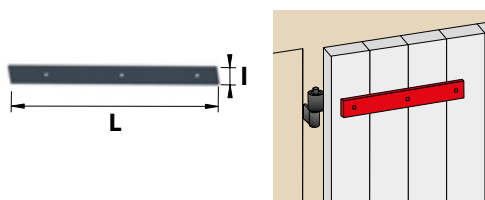

Contre-penture aluminium bout droit

Code	Gencod		L	I	Ep.	Type packaging	
1402355	3308181402352		355	39	3	Vrac gencodé	4
1402500	3308181402505		500	39	3	Vrac gencodé	4

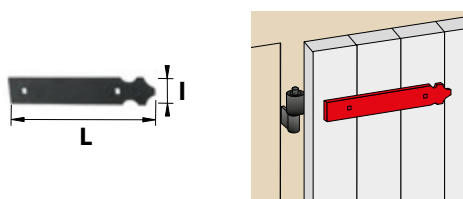

Contre-penture aluminium bout feston

Code	Gencod		L	I	Ep.	Type packaging	
1404370	3308181404370		370	39	2	Vrac gencodé	4
1404515	3308181404516		515	39	2	Vrac gencodé	4

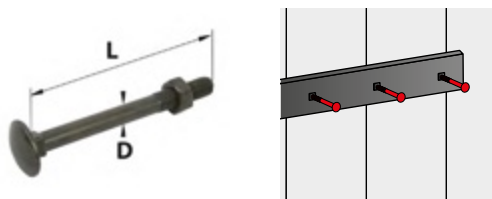

Boulon TRCC aluminium (x8)

Code	Gencod		D	L	Type packaging	
1405645	3221684056450		6	45	Brochable gencodé	1

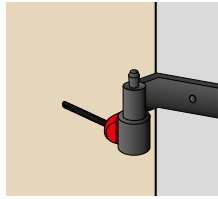

Bague de propreté pour gond

Code	Gencod		L	H	Type packaging	
0960000	3308189600002		47	13	Vrac gencodé	5
0959900	3308189599009		47	13	Vrac gencodé	5

Gonds

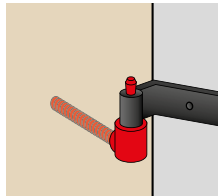
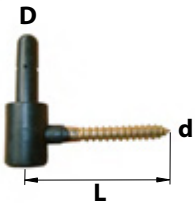

Gond à visser composite

Code	Gencod		D	d	L	Type packaging	
0214800	3308182148006		14	10	95	Vrac gencodé	1
0645000	3308186450006		14	10	95	Vrac gencodé	1

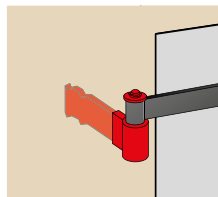
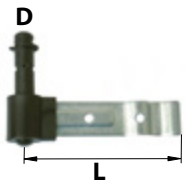

Gond à sceller composite

Code	Gencod		D	L	Type packaging	
0214600	3308182146002		14	115	Vrac gencodé	1
0591100	3308185911003		14	115	Vrac gencodé	1

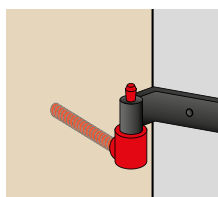
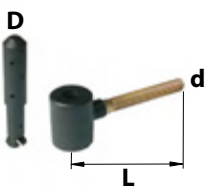

Gond à scellement chimique composite

Code	Gencod		D	d	L	Type packaging	
0215300	3308182153000		14	M10	135	Vrac gencodé	1
0661200	3308186612008		14	M10	135	Vrac gencodé	1

Arrêts de volets à visser



La mise en œuvre des fermetures est encadrée par le DTU 34-4, s'y référer pour éviter tout danger.

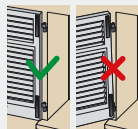

Bien s'assurer que le vantail soit monté plaqué et serré sur la façade.



En cas de vent, fermer les volets.



Pour les volets de grandes tailles, utiliser uniquement les arrêts adaptés



Conseils de pose P.133



Plus d'infos sur www.afbat.com

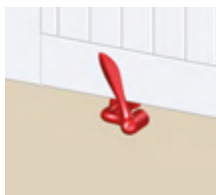
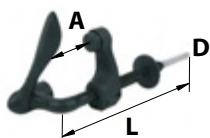

Tourniquet marseillais composite * Hélice à rouleau

Code	Gencod		D	L	A	Type packaging		
0997300	3308189973007		10	160	12/46	Vrac gencodé		1
0997400	3308189974004		10	160	12/46	Vrac gencodé		1

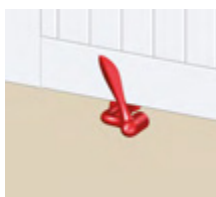
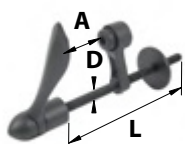

Tourniquet marseillais zamak * Hélice à rouleau

Code	Gencod		D	L	A	Type packaging		
1010600	3308180106008		10	165	12/60	Vrac gencodé		1
1010700	3308180107005		10	265	12/110	Vrac gencodé		1

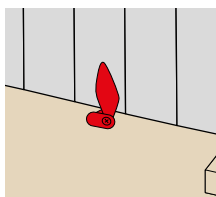
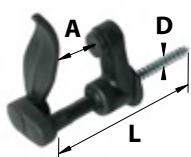

Tourniquet marseillais composite à visser S4000 *

Code	Gencod		D	L	A	Type packaging		
0951700	3308189517003		10	130	12/46	Vrac gencodé		5
0951900	3308189519007		10	200	12/116	Vrac gencodé		5
0951600	3308189516006		10	130	12/46	Vrac gencodé		5
0951800	3308189518000		10	200	12/116	Vrac gencodé		5
0951750	3308189517508		10	130	12/46			10

Arrêts tête de bergère à visser

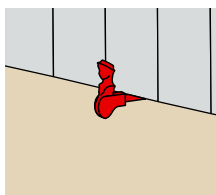
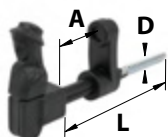

Arrêt tête bergère composite à visser S4000 *

Code	Gencod		D	L	A	Type packaging		
501320	3221685013209		10	200	22/65	Vrac gencodé		1
501315	3221685013155		10	200	22/65	Vrac gencodé		1

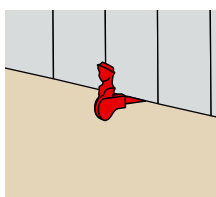
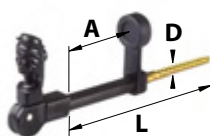

Arrêt tête bergère zamak à visser *

Code	Gencod		D	L	A	Type packaging		
0955206	3308189552066		10	150	40/70	Brochable gencodé		1
0954926	3308189549264		10	150	40/70	Brochable gencodé		1



La mise en œuvre des fermetures est encadrée par le DTU 34-4, s'y référer pour éviter tout danger.

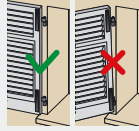

Bien s'assurer que le vantail soit monté plaqué et serré sur la façade.



En cas de vent, fermer les volets.



Pour les volets de grandes tailles, utiliser uniquement les arrêts adaptés



Conseils de pose P.133



Plus d'infos sur www.afbat.com

Arrêt composite automatique *

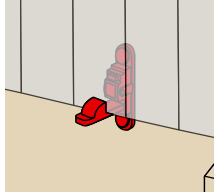

Code	Gencod		A	I	H	Type packaging	
0108600	3308181086002		6/36	32	110	Vrac gencodé	10
0108800	3308181088006		6/86	32	110	Vrac gencodé	10
0108700	3308181087009		6/36	32	110	Vrac gencodé	1
0108900	3308181089003		6/86	32	110	Vrac gencodé	1
0260000	3308182600009		6/36	32	110		20
0942100	3308189421003		6/86	32	110		10

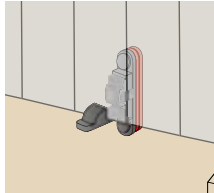

Cale arrêt composite automatique

Code	Gencod		I	H	Ep.	Type packaging	
0962200	3308189622004		36	116	10	Vrac gencodé	5
0962100	3308189621007		36	116	10	Vrac gencodé	5

Arrêt automatique aluminium *

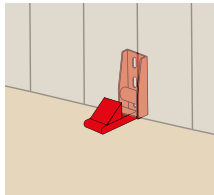

Code	Gencod		I	H	Type packaging	
Pour volet de 40 à 58 mm						
4631002	3221684631022		24,5	90	Vrac gencodé	1
4631001	3221684631008		24,5	90	Vrac gencodé	1

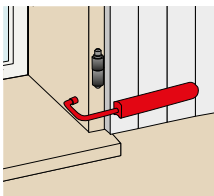
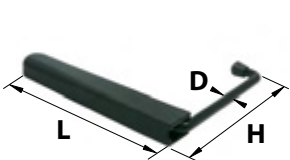

Arrêt de volet Veruilvolet (x2)

Code	Gencod		D	L	H	Type packaging	
0952400	3308189524001		12	250	135	Brochable gencodé	1
0958500	3308189585002		12	250	135	Brochable gencodé	1



La mise en œuvre des fermetures est encadrée par le DTU 34-4, s'y référer pour éviter tout danger.



Surface maximum 1 m² par vantail.

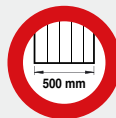

Largeur maximum du volet : 500 mm.



Ne pas utiliser en zone venteuse.



En cas de vent, fermer les volets.



Utiliser tous les trous de fixation prévus à cet effet (5) pour fixer la pièce.



Vérifier le serrage régulièrement.



Conseils de pose P.133



Plus d'infos sur www.afbat.com



La mise en œuvre des fermetures est encadrée par le DTU 34-4, s'y référer pour éviter tout danger.

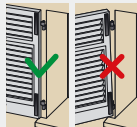

Bien s'assurer que le vantail soit monté plaqué et serré sur la façade.



En cas de vent, fermer les volets.



Pour les volets de grandes tailles, utiliser uniquement les arrêts adaptés



Conseils de pose P.133



Plus d'infos sur www.afbat.com

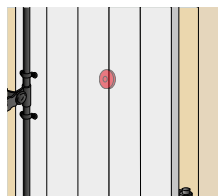
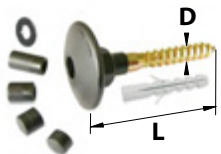

Butée murale composite à visser *

Code	Gencod		D	L	Type packaging	
0956100	3308189561006		10	75	Brochable gencodé	1

Crochets + crémaillères

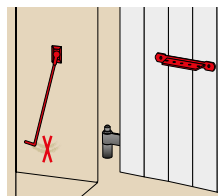
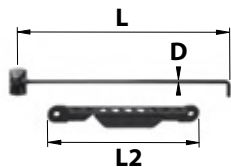

Crochet aluminium sur platine anti-choc + crémaillère à poignée

Code	Gencod		D	L	L2	Type packaging	
0956801	3308189568012		8	480	180	Brochable gencodé	1

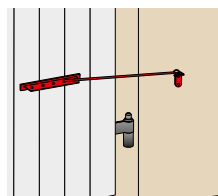
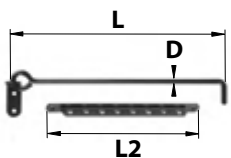

Crochet aluminium sur platine + crémaillère en T

Code	Gencod		D	L	L2	Type packaging	
0963201	3308189632010		8	300	180	Vrac gencodé	5
0963226	3308189632263		8	300	180	Vrac gencodé	5

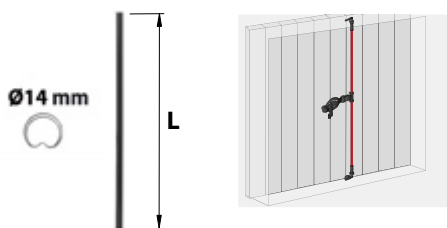

Tube espagnolette rainurée aluminium

Code	Gencod		D	L	Type packaging	
620500	3221686205009		14	1270	Vrac gencodé	1
620502	3221686205023		14	1570	Vrac gencodé	1
465627	3221684656278		14	1270	Vrac gencodé	1
465626	3221684656261		14	1570	Vrac gencodé	1



Accessoires espagnolette zamak rainurée

Code	Gencod		Type packaging	
0959800	3308189598002		Brochable gencodé	1

Composition

- 1 poignée sécurité intégrée
- 1 support
- 4 lacets
- 2 crochets

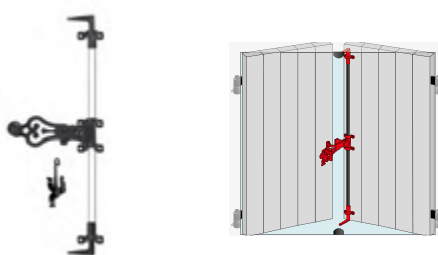

Accessoires espagnolette aluminium rainurée

Code	Gencod		Type packaging	
0954200	3308189542005		Brochable gencodé	1
0954100	3308189541008		Brochable gencodé	1

Composition

- 1 poignée
- 1 support antisoulèvement
- 4 lacets
- 2 crochets

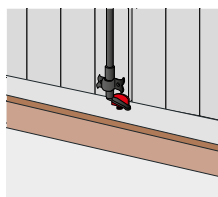

Butée à vis + tampon composite

Code	Gencod		D	L	I	Type packaging	
0961800	3308189618007		6,5	65	39	Brochable gencodé	1
0961700	3308189617000		6,5	65	39	Brochable gencodé	1

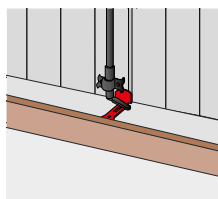
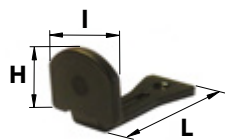

Butée coudée réglable à visser + tampon composite

Code	Gencod		L	I	H	Type packaging	
0962000	3308189620000		66	39	40	Brochable gencodé	1
0961900	3308189619004		66	39	40	Brochable gencodé	1
0941700	3308189417006		66	39	40		25



L'EXTÉRIEUR DE L'HABITAT

L'ISOLATION EXTÉRIEURE

A chaque produit son cas de figure

Afin de répondre de la meilleure façon à tous les types de pose, AFBAT® propose un large éventail de produits adaptés à des contraintes spécifiques.

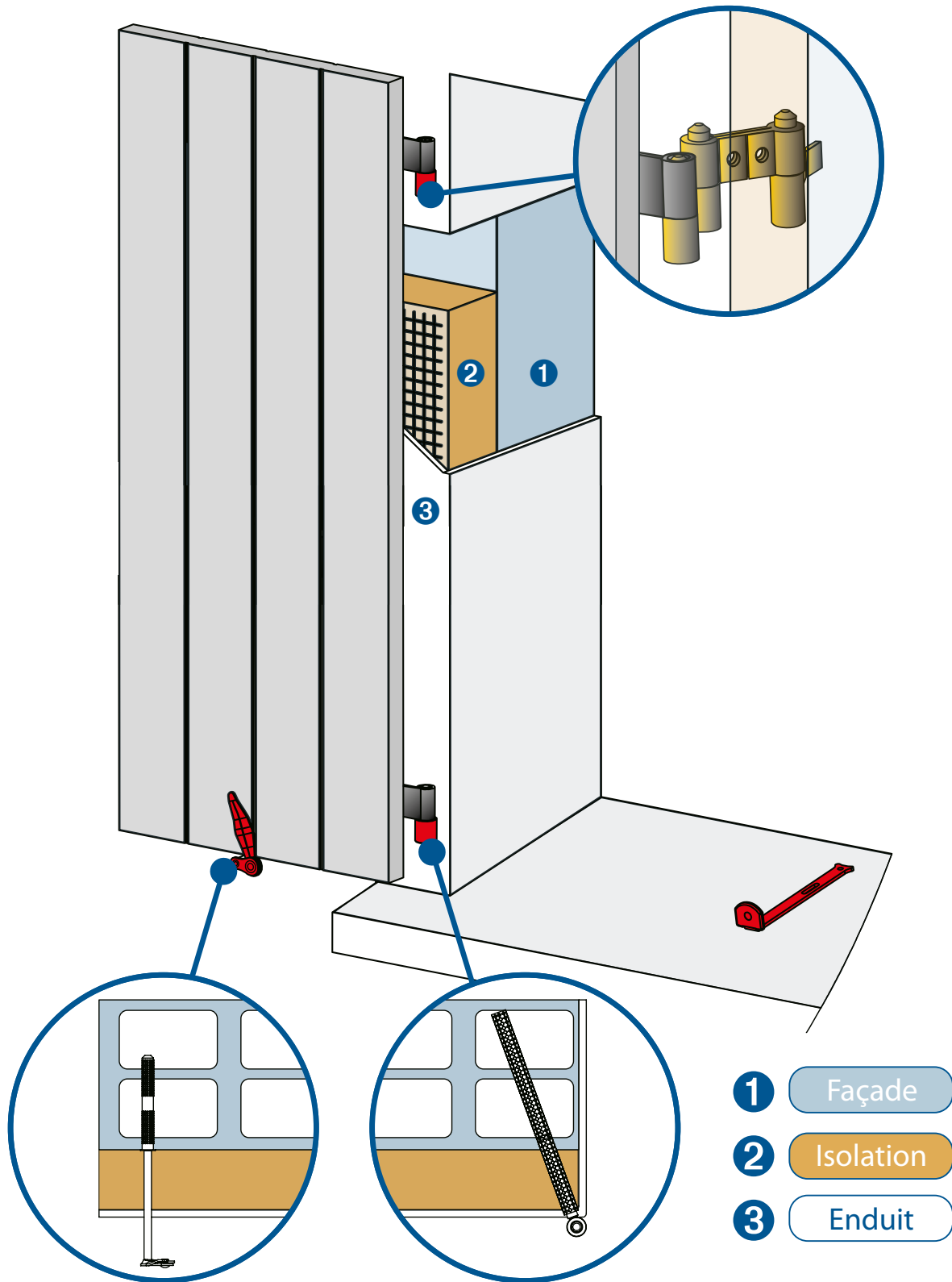

Gond à scellement chimique composite (kit)

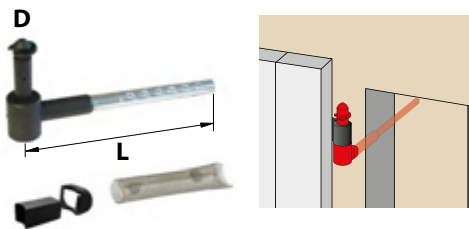

Code	Gencod		D	L	Type packaging	
0419401	3308184194018		14	180	Vrac gencodé	1
0432501	3308184325016		14	300	Vrac gencodé	1

Composition
 1 gond
 1 entretoise
 1 bague de propreté
 1 tamis métallique

Gond à scellement chimique acier (kit)

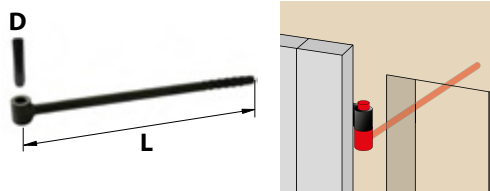

Code	Gencod		D	D2	L	Type packaging	
0443501	3308184435012		14	14	180	Vrac gencodé	1
0467801	3308184678013		14	14	300	Vrac gencodé	1
61ISOXT35M	3517650578676		14	20	350	Vrac gencodé	10

Composition
 1 gond
 1 tamis métallique
 1 élastique

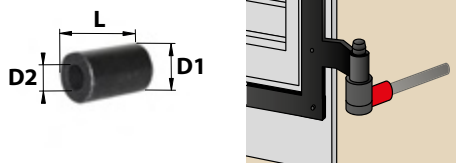

Entretoise pour gond acier (x2)

Code	Gencod		L	D1	D2	Type packaging	
0952701	3308189527019		43,2	20	11	Brochable gencodé	1

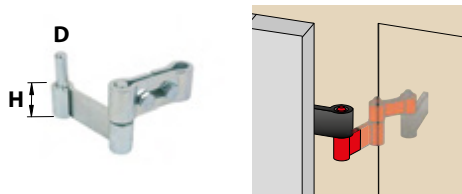

Gond pour isolation extérieure Isogond

Code	Gencod		D	H	Ep.	Type packaging	
0417303	3308184173037	Z.BLANC	14	30	5	Vrac gencodé	1
0417403	3308184174034	Z.BLANC	16	30	5	Vrac gencodé	1

Arrêts de volets à visser



La mise en œuvre des fermetures est encadrée par le DTU 34-4, s'y référer pour éviter tout danger.

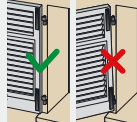

Bien s'assurer que le vantail soit monté plaqué et serré sur la façade.



En cas de vent, fermer les volets.



Pour les volets de grandes tailles, utiliser uniquement les arrêts adaptés.



Conseils de pose P.138



Plus d'infos sur www.afbat.com

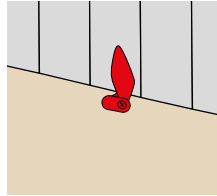
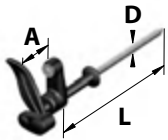

Tourniquet marseillais composite à visser *

Code	Gencod		D	L	A	Type packaging	
0418501	3308184185016		10	280	12/116	Vrac gencodé	1
0418702	3308184187027		10	280	12/116	Vrac gencodé	1

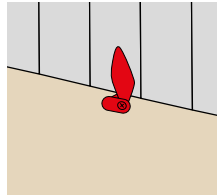

Tourniquet marseillais acier à visser *

Code	Gencod		D	L	Type packaging	
0426701	3308184267019		10	180		20
0417501	3308184175017		10	250	Vrac gencodé	1

Arrêts tête bergère à visser

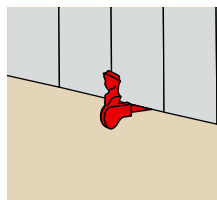
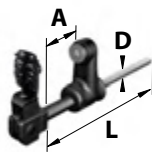

Arret tête bergère composite à visser *

Code	Gencod		D	L	A	Type packaging	
0418801	3308184188017		10	280	22/115	Vrac gencodé	1

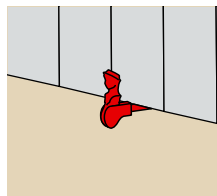
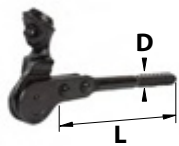

Arret tête bergère acier à visser *

Code	Gencod		D	L	Type packaging	
0787501	3308187875013		10	250	Vrac gencodé	5



L'EXTÉRIEUR DE L'HABITAT

LA SÉCURITÉ DU VOLET

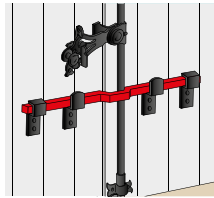
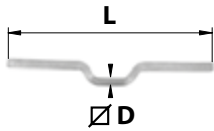

Barre de sécurité renforcée

Code	Gencod		∅ D	L	Type packaging	
0640903	3308186409035	Z.BLANC	16	410	Vrac gencodé	1
0705903	3308187059031	Z.BLANC	16	980	Vrac gencodé	1
0706003	3308187060037	Z.BLANC	16	1480	Vrac gencodé	1

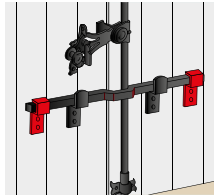
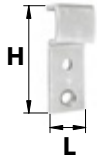

Support antisoulèvement barre de sécurité pour carré 16

Code	Gencod		L	H	Ep.	Type packaging	
(x1)							
0802103	3308180030778	Z.BLANC	25	69,5	3,5	Vrac gencodé	10
0247403	3308182474037	Z.BLANC	25	69,5	3,5		100
(x2)							
0711603	3308187116031	Z.BLANC	25	69,5	3,5	Brochable gencodé	1

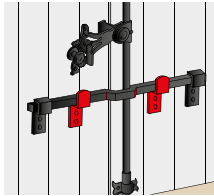
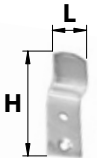

Support simple barre de sécurité pour carré 16

Code	Gencod		L	H	Ep.	Type packaging	
(x1)							
0801903	3308180030761	Z.BLANC	25	75	3,5	Vrac gencodé	10
0247503	3308182475034	Z.BLANC	25	75	3,5		100

Support simple (x2) + contre-plaque (x2)

0711504	3308187115041		25	75	3,5	Brochable gencodé	1
0711503	3308187115034	Z.BLANC	25	75	3,5	Brochable gencodé	1

Support simple barre (x4) + Visserie

0409203	3308184092031	Z.BLANC	25	75	3,5	Brochable gencodé	1
---------	---------------	---------	----	----	-----	-------------------	---

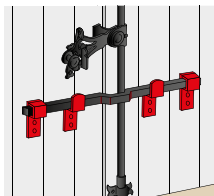

Kit support barre de sécurité pour carré 16

Code	Gencod		Type packaging	
Support simple (x2) + antisoulèvement (x2) + Visserie				
0318104	3308183181040		Vrac gencodé	1
0318103	3308183181033	Z.BLANC	Vrac gencodé	1
Support simple (x2) + antisoulèvement (x2) + contre-plaques (x4) + Visserie				
0409103	3308184091034	Z.BLANC	Brochable gencodé	1

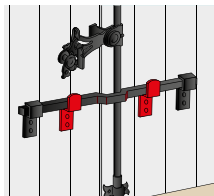
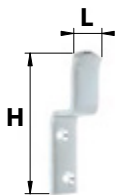

Support ouvert barre de sécurité

Code	Gencod		L	H	Type packaging	
Pour carré de 25 mm						
6139025	3221686139250	Z.BLANC	20	94	Vrac gencodé	10
Pour carré de 25 à 36 mm						
6139036	3221686139366	Z.BLANC	20	94	Vrac gencodé	10

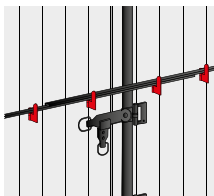
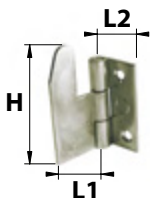

Support charnière pour barre de sécurité 12 mm

Code	Gencod		L1	L2	H	Ep.	Type packaging	
A visser - Modèle droite								
538130	3479045381301	Z.BLANC	34	23,5	67	2	Vrac gencodé	10
A visser - Modèle gauche								
538140	3479045381400	Z.BLANC	34	23,5	67	2	Vrac gencodé	10

Modèle droite

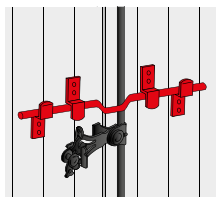
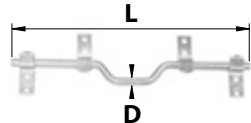

Barre de sécurité ronde

Code	Gencod		∅ D	L	Type packaging	
0337103	3308183371038	Z.BLANC	14	410	Brochable gencodé	1

Composition
 1 barre de sécurité L41 cm
 4 supports droits
 Visserie

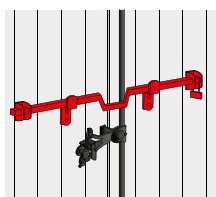
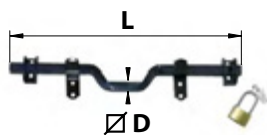

Barre de sécurité renforcée + cadenas

Code	Gencod		∅ D	L	Type packaging	
0337504	3308183375043		16	410	Brochable gencodé	1

Composition
 1 barre de sécurité L41 cm percée pour passage du cadenas
 2 supports droits + 2 supports sécurité
 1 cadenas
 Visserie

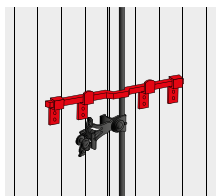
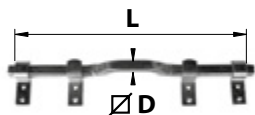

Barre de sécurité renforcée

Code	Gencod		∅ D	L	Type packaging	
0707004	3308180029949		16	410	Brochable gencodé	1
0802204	3308188022041		16	980	Brochable gencodé	1
0707003	3308187070036	Z.BLANC	16	410	Brochable gencodé	1
0802203	3308180029796	Z.BLANC	16	980	Brochable gencodé	1

Composition
 1 barre de sécurité
 2 supports simples
 2 supports anti-soulèvements
 4 contre-plaques (uniquement pour L98 cm)
 Visserie

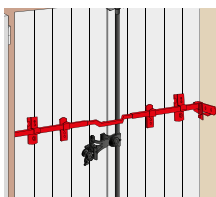
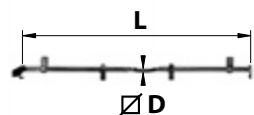

Barre de sécurité réglable 6 points

Code	Gencod		∅ D	L	Type packaging	
0704404	3308187044044		16	410	Brochable gencodé	1

Composition
 1 barre de sécurité L41 cm
 2 rallonges
 2 supports intermédiaires
 2 supports verrous
 2 supports tableau

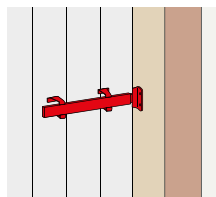
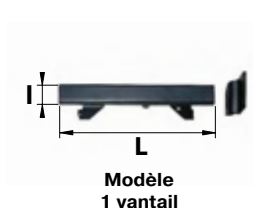

Barre de sécurité verrou

Code	Gencod		L	I	Type packaging	
1 vantail						
0337706	3308183377061		245	30	Brochable gencodé	1
2 vantaux						
0777406	3308180029802		245 + 245	30	Brochable gencodé	1

Composition

Pour 1 vantail :

- 1 fourreau avec pêne cadenassable
- 1 gâche murale à visser
- Visserie

Pour 2 vantaux :

- 1 fourreau avec pêne cadenassable
- 1 fourreau sans pêne
- Visserie

Barre de sécurité à boutons

Code	Gencod		L	Type packaging	
0318304	3308183183044		450	Brochable gencodé	1

Composition

- 1 barre de sécurité L450 mm
- 2 supports simples
- 2 supports antisoulèvement
- Visserie

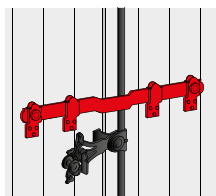

Barre de sécurité plate à ergots

Code	Gencod		L	Type packaging	
Acier					
0174403	3308181744032	Z.BLANC	450	Brochable gencodé	1
Aluminium					
0312906	3308183129066		450	Brochable gencodé	1
0312926	3308183129264		450	Brochable gencodé	1

Composition

- 1 barre de sécurité L450 mm
- 2 supports simples
- 2 supports antisoulèvement
- Visserie

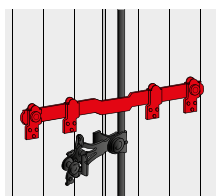

Entrebâilleur de volet

Code	Gencod		L	I	Type packaging	
0700104	3308180040555		285	83	Brochable gencodé	1
0700103	3308187001030	Z.BLANC	285	83	Brochable gencodé	1
0942703	3308189427036	Z.BLANC	285	83		5

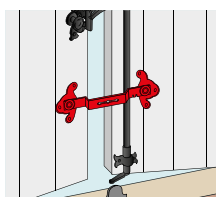
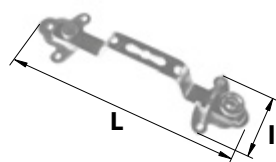



L'EXTÉRIEUR DE L'HABITAT

LES PERSIENNES

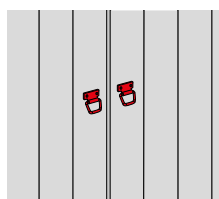
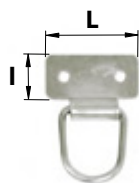

Anneau de tirage (x2)

Code	Gencod		L	I	Type packaging	
0952303	3308189523035	Z.BLANC	40	20	Brochable gencodé	1

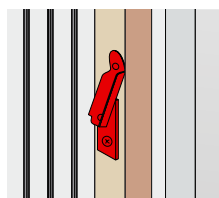

Modèle gauche

Arrêt de persienne à visser

Code	Gencod		L	I	H	Ep.	Type packaging		
Modèle droite									
0382703	3308183827030	Z.BLANC	90	20	60	3	Vrac gencodé	10	
Modèle gauche									
0382603	3308183826033	Z.BLANC	90	20	60	3	Vrac gencodé	10	
Modèle droite + gauche									
0701503	3308187015037	Z.BLANC	90	20	60	3	Brochable gencodé	1	

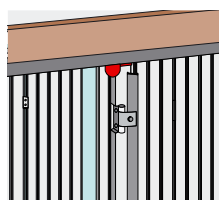

Butée de persienne à visser

Code	Gencod		L	I	H	Ep.	Type packaging		
Modèle haut									
538071	3221685380714		30	23	27	2,5	Vrac gencodé	10	
538070	3479045380700	Z.BLANC	30	23	27	2,5	Vrac gencodé	10	
0961603	3308189616034	Z.BLANC	30	20	31	2,5	Brochable gencodé	1	
Modèle bas									
538081	3479045380816		30	30	30	2,5	Vrac gencodé	10	
538080	3479045380809	Z.BLANC	30	30	30	2,5	Vrac gencodé	10	
538090	3479045380908	Z.BLANC	30	23	36	2,5	Vrac gencodé	10	
0961503	3308189615037	Z.BLANC	30	30,5	30	2,5	Brochable gencodé	1	

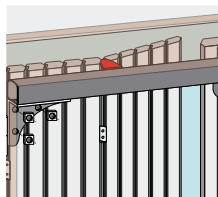
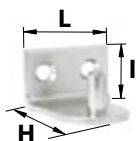

Crochet de rappel

Code	Gencod		L	I	H	Ep.	Type packaging	
0962803	3308189628037	Z.BLANC	30	20	31	2,5	Brochable gencodé	1

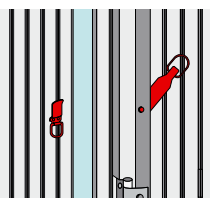

Loquet droit + support

Code	Gencod		L	Ep.	Type packaging	
0957303	3308189573030	Z.BLANC	98	2,5	Brochable gencodé	1

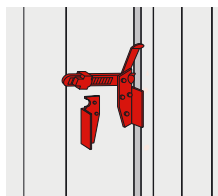

Loquet de persienne + support

Code	Gencod		L	Ep.	Type packaging	
0963916	3308189639163	GRIS	201	2,5	Brochable gencodé	1

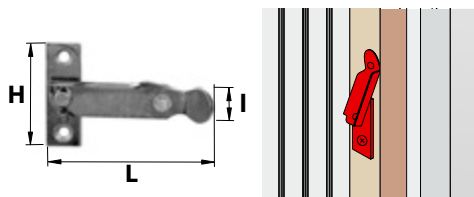

Modèle droite

Arrêt de persienne inox à visser + butée

Code	Gencod		L	I	H	Ep.	Type packaging	
Modèle droite								
0960500	3308189605007	304L	113,5	21	62	2	Vrac gencodé	1
Modèle gauche								
0960600	3308189606004	304L	113,5	21	62	2	Vrac gencodé	1

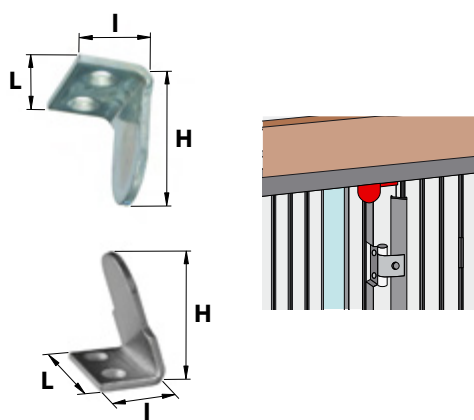

Butée de persienne inox à visser

Code	Gencod		L	I	H	Ep.	Type packaging	
Modèle haut								
0962703	3308189627030	304L	30	20	30,5	2	Brochable gencodé	1
Modèle bas								
0961403	3308189614030	304L	30	20	40	2	Brochable gencodé	1

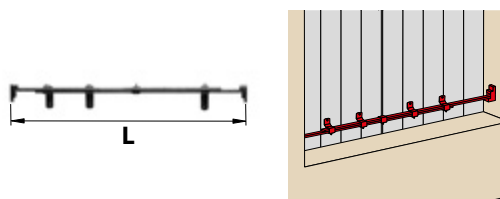

Barre de sécurité persienne recoupable

Code	Gencod		L	Type packaging	
0704203	3308187042033	Z.BLANC	1600	Brochable gencodé	1



L'EXTÉRIEUR DE L'HABITAT

LE VOLET ROULANT

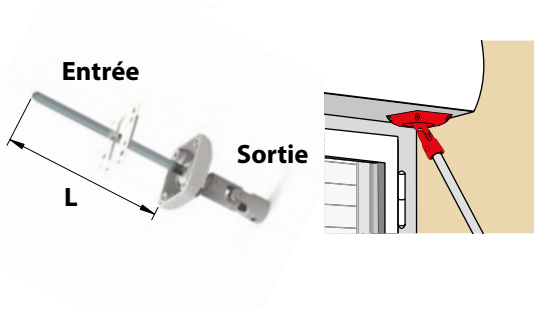

Sortie de caisson à 45°

Code	Gencod		L	Entrée	Sortie	Type packaging	
0840900	3308188409002	<input type="text"/>	315	● 7	● 12	Brochable gencodé	1

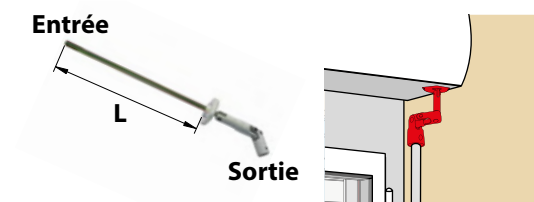

Sortie de caisson déportée

Code	Gencod		L	Entrée	Sortie	Type packaging	
0841200	3308188412002	<input type="text"/>	210	● 7	● 12	Brochable gencodé	1

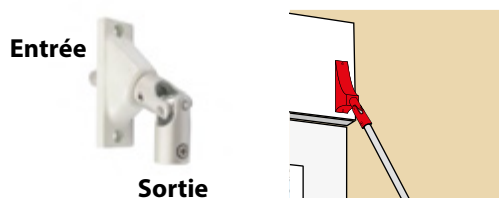

Sortie de caisson treuil à 90° + double cadran

Code	Gencod		Entrée	Sortie	Type packaging	
0841300	3308188413009	<input type="text"/>	● 7	● 12	Brochable gencodé	1

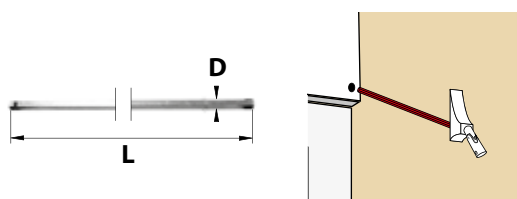

Tige passe-caisson recoupable

Code	Gencod		L	D	Type packaging	
0840700	3308188407008	Z.BLANC	300	● 7	Vrac gencodé	1

Entrée



Sortie

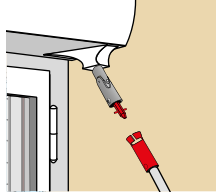

Kit manivelle décrochable

Code	Gencod		Entrée	Sortie	Type packaging	
0851500	3308188515000	<input type="text"/>	● 10	● 12	Brochable gencodé	1



Sortie

Entrée

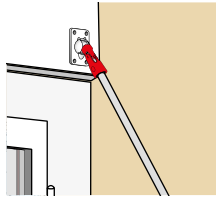

Genouillère acier chrome

Code	Gencod		Entrée	Sortie	Type packaging	
0842200	3308188422001	CHROME	● 7	● 12	Brochable gencodé	1
0842800	3308188428003	CHROME	● 10	● 12	Brochable gencodé	1
0842400	3308188424005	CHROME	● 10	● 10	Brochable gencodé	1
0842600	3308188426009	CHROME	● 12	● 12	Brochable gencodé	1



Sortie

Entrée

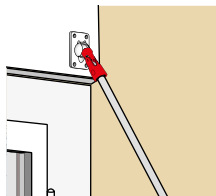

Genouillère acier laqué

Code	Gencod		Entrée	Sortie	Type packaging	
0877600	3308188776005	<input type="text"/>	● 7	● 12	Brochable gencodé	1
0878100	3308188781009	<input type="text"/>	● 10	● 12	Brochable gencodé	1
0877700	3308188777002	<input type="text"/>	● 10	● 10	Brochable gencodé	1
0877900	3308188779006	<input type="text"/>	● 12	● 12	Brochable gencodé	1

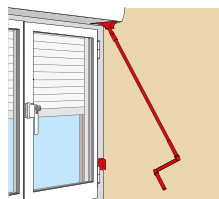
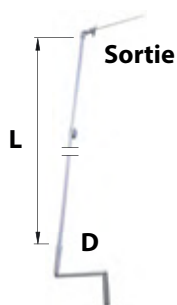

Kit manivelle complet classic

Code	Gencod		Sortie	D	L	Type packaging	
0843500	3308188435001	<input type="text"/>	● 7	● 12	1100	Vrac gencodé	1
0963800	3308189638005	<input type="text"/>	● 10	● 12	1100	Vrac gencodé	1

Composition
 1 sortie de caisson
 1 tringle
 1 poignée manivelle
 1 bloqueur de manivelle
 Visserie

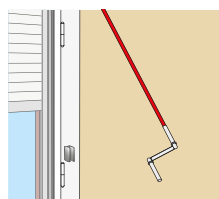

Tringle manivelle

Code	Gencod		D	L	Type packaging	
0843700	3308188437005	<input type="text"/>	● 12	900	Vrac gencodé	1
0843600	3308188436008	<input type="text"/>	● 12	1100	Vrac gencodé	1

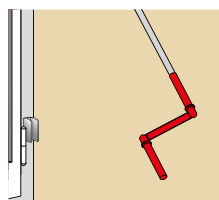

Poignée de manivelle pour tringle Ø12 mm

Code	Gencod		Type packaging	
0843200	3308188432000	<input type="text"/>	Brochable gencodé	1

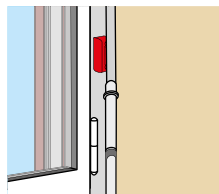

Bloqueur de manivelle magnétique

Code	Gencod		Type packaging	
Pour manivelle acier ● 12 mm et ● 10 mm				
0844000	3308188440005	<input type="text"/>	Brochable gencodé	1

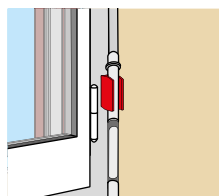

Bloqueur de manivelle design

Code	Gencod		Type packaging	
Pour manivelle acier ● 12 mm				
0841100	3308188411005	<input type="text"/>	Brochable gencodé	1

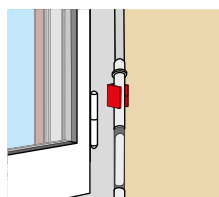

Bloqueur de manivelle classic

Code	Gencod		Type packaging	
Pour manivelle acier ● 12 mm				
0844100	3308188441002	<input type="text"/>	Brochable gencodé	1

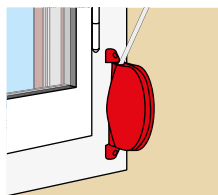

Enrouleur sous carter pivotant pour sangle 14/15 mm

Code	Gencod		Type packaging	
0846200	3308188462007	<input type="text"/>	Vrac gencodé	1

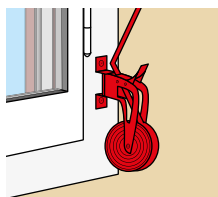

Enrouleur pivotant pour sangle 20/22 mm

Code	Gencod		Type packaging	
0846500	3308188465008	Z.BLANC	Vrac gencodé	1

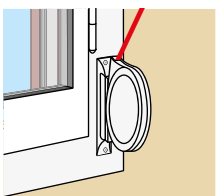

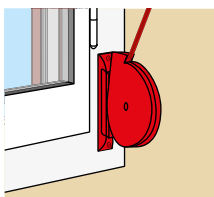

Sangle

Code	Gencod		L	Type packaging	
114/15 mm					
0850500	3308188505001	<input type="text"/>	6000	Brochable gencodé	1
0933400	3308189334006	<input type="text"/>	6000		10
120/22 mm					
0851000	3308188510005	<input type="text"/>	5500	Brochable gencodé	1





**Enrouleur pivotant réglable
+ sangle 14/15 mm L5,8m**

Code	Gencod		Type packaging	
0957100	3308189571005	<input type="checkbox"/>	Brochable gencodé	1
0845100	3308188451001	<input type="checkbox"/>	Brochable gencodé	1

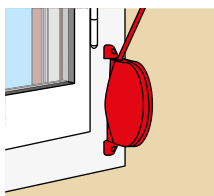
Mise en tension et changement de la sangle possible sans démonter le boîtier.



Enrouleur sous carter pivotant + sangle 14/15 mm L6m

Code	Gencod		Type packaging	
0957000	3308189570008	<input type="checkbox"/>	Vrac gencodé	1
0844800	3308188448001	<input type="checkbox"/>	Brochable gencodé	1
0933300	3308189333009	<input type="checkbox"/>		4

Accessoires volets roulants à sangle



14/15 mm

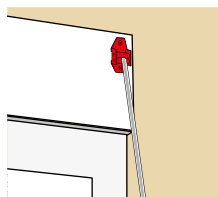

20/22 mm

Guide-sangle classic

Code	Gencod		Type packaging	
Pose horizontale pour sangle I14/15 mm				
0848700	3308188487000	<input type="checkbox"/>	Brochable gencodé	1
Pose verticale pour sangle I20/22 mm				
0848600	3308188486003	<input type="checkbox"/>	Brochable gencodé	1



14/15 mm

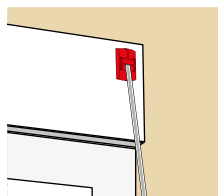

Guide-sangle design

Code	Gencod		Type packaging	
Pose horizontale + fixations invisibles				
0849500	3308188495005	<input type="checkbox"/>	Brochable gencodé	1
Pose verticale + fixations invisibles				
0849000	3308188490000	<input type="checkbox"/>	Brochable gencodé	1

Accessoires volets roulants à cordon

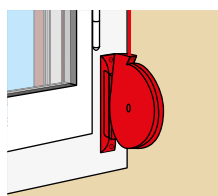

Enrouleur pivotant réglable à cordon

Code	Gencod		Type packaging	
0956900	3308189569002	<input type="checkbox"/>	Brochable gencodé	1

Accessoires volets roulants à chaîne

Ø4,5 mm

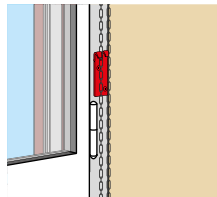

Arrêt de chaîne

Code	Gencod		Type packaging	
0851400	3308188514003	Z.BLANC	Brochable gencodé	1



14/22 mm

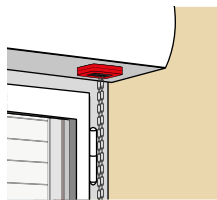

Guide STOPVENT chaîne ou sangle

Code	Gencod		Type packaging	
0847500	3308188475007		Brochable gencodé	1

Accessoires volets roulants à tirage direct

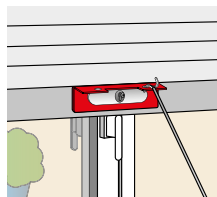
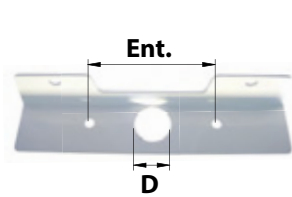

Poignée de tirage

Code	Gencod		D	Ent.	Type packaging	
0851900	3308188519008		25	90	Brochable gencodé	1

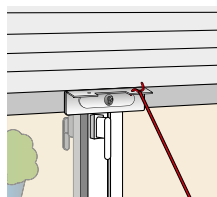
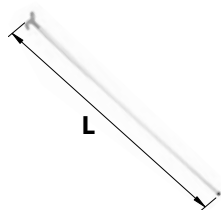

Bâton de tirage

Code	Gencod		L	Type packaging	
0851800	3308188518001		1000	Brochable gencodé	1

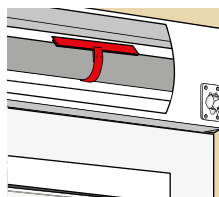

Attache souple lame épaisse (x2)

Code	Gencod		L	Type packaging	
------	--------	--	---	----------------	--

Pour tablier court

0881200	3308188812000		140	Brochable gencodé	1
---------	---------------	--	-----	-------------------	---

Pour tablier long

0842000	3308188420007		180	Brochable gencodé	1
---------	---------------	--	-----	-------------------	---

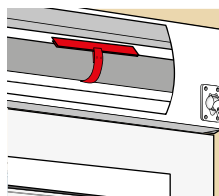
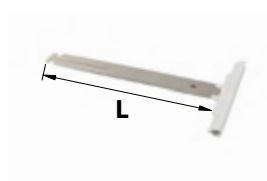

Attache souple lame souple (x2)

Code	Gencod		L	Type packaging	
------	--------	--	---	----------------	--

Pour tablier court

0843950	3308188439504		150	Brochable gencodé	1
---------	---------------	--	-----	-------------------	---

Pour tablier long

0843980	3308188439801		180	Brochable gencodé	1
---------	---------------	--	-----	-------------------	---

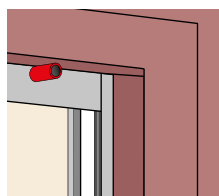
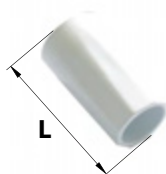

Butée de lame finale (x2)

Code	Gencod		L	Type packaging	
------	--------	--	---	----------------	--

0851300	3308188513006		40	Brochable gencodé	1
---------	---------------	--	----	-------------------	---

0851200	3308188512009		40	Brochable gencodé	1
---------	---------------	--	----	-------------------	---

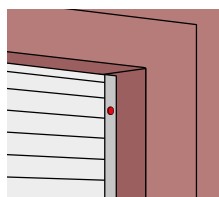
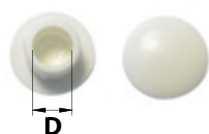

Bouchon de protection (x10)

Code	Gencod		D	Type packaging	
------	--------	--	---	----------------	--

0851700	3308188517004		10	Brochable gencodé	1
---------	---------------	--	----	-------------------	---

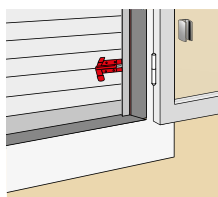

Verrou antisoulèvement (x2)

Code	Gencod		Type packaging	
1018302	3308180183023	Z.BLANC	Brochable gencodé	1

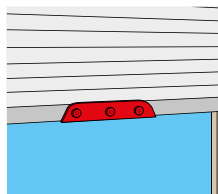
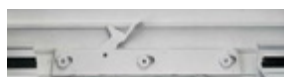

Barre de verrouillage volet roulant

Code	Gencod		Type packaging	
0700426	3308187004260		Brochable gencodé	1

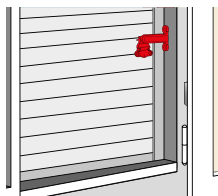

Kit verrouillage automatique volet roulant

Code	Gencod		Type packaging	
0996500	3308189965002		Brochable gencodé	1

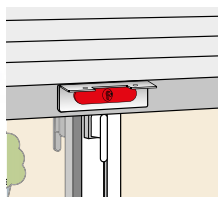

Serrure extraplate 3 clés

Code	Gencod		Type packaging	
0851600	3308188516007		Brochable gencodé	1



L'EXTÉRIEUR DE L'HABITAT

LA GAMME INOX

LA GAMME INOX

Paumelles

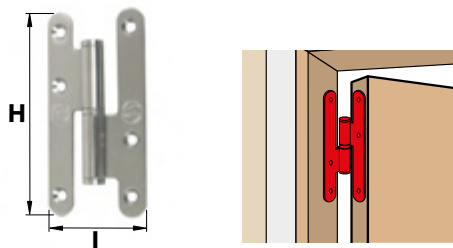

Modèle droite

Paumelle de Paris bois inox bouts ronds

Code	Gencod		H	I	Type packaging	
Droite						
532320	3479045323202	INOX 304L	110	55	Vrac gencodé	10
532330	3479045323301	INOX 304L	140	55	Vrac gencodé	10
532340	3479045323400	INOX 304L	140	70	Vrac gencodé	10
532350	3479045323509	INOX 304L	160	80	Vrac gencodé	10
Gauche						
532325	3479045323257	INOX 304L	110	55	Vrac gencodé	10
532335	3479045323356	INOX 304L	140	55	Vrac gencodé	10
532345	3479045323455	INOX 304L	140	70	Vrac gencodé	10
532355	3479045323554	INOX 304L	160	80	Vrac gencodé	10

Pentures et charnières

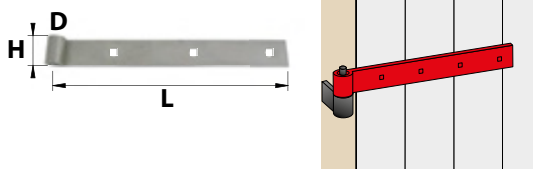

Penture bout droit inox

Code	Gencod		D	L	H	Ep.	Type packaging	
0161900	3308181619002	INOX 304L	14	289	35	4	Vrac gencodé	1
0162000	3308181620008	INOX 304L	14	389	35	4	Vrac gencodé	1
0162100	3308181621005	INOX 304L	14	489	35	4	Vrac gencodé	1
0162200	3308181622002	INOX 304L	14	589	35	4	Vrac gencodé	1
0694800	3308186948008	INOX 316L	16	1000	40	5	Vrac gencodé	1

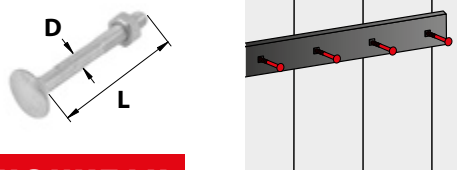

NOUVEAU

Boulon TRCC inox

Code	Gencod		D	L	Type packaging	
629874	3221686298742	INOX 316L	6	45	Brochable gencodé	1
629877	3221686298773	INOX 316L	6	70	Brochable gencodé	1

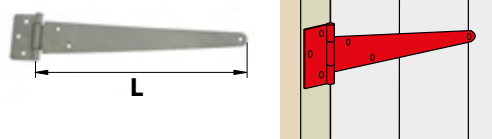

Penture anglaise inox

Code	Gencod		L	Ep.	Type packaging	
2011150	3221682011154	INOX 316L	150	2	Vrac gencodé	1
2011200	3221682011208	INOX 316L	200	2	Vrac gencodé	1
0452200	3308184522002	INOX 316L	250	2	Vrac gencodé	1
2011300	3221682011307	INOX 316L	300	2	Vrac gencodé	1

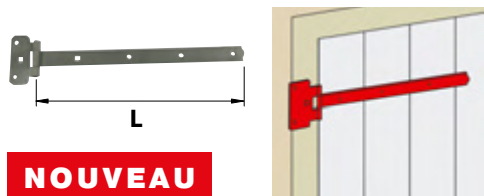

NOUVEAU

Penture anglaise festonnée inox

Code	Gencod		L	Ep.	Type packaging	
629330	3308186293306	INOX 316L	300	3	Vrac gencodé	1
629340	3308186293405	INOX 316L	400	3	Vrac gencodé	1
629350	3308186293504	INOX 316L	500	3	Vrac gencodé	1
629360	3308186293603	INOX 316L	600	3	Vrac gencodé	1

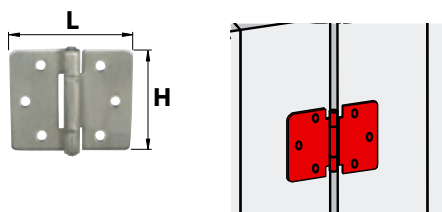

Charnière renforcée inox

Code	Gencod		L	H	Ep.	Type packaging	
0742500	3308187425003	INOX 316L	75	65	2	Vrac gencodé	1

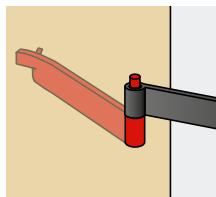

Gond à sceller inox + axe laiton

Code	Gencod		D	L	Ep.	Type packaging	
0606000	3308186060007	INOX 316L	14	135	4	Vrac gencodé	1

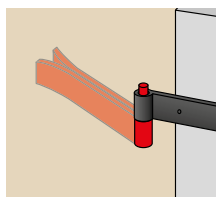
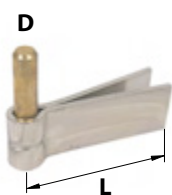

Gond à sceller 2 lames inox + axe laiton

Code	Gencod		D	L	Ep.	Type packaging	
0708350	3308187083500	INOX 316L	16	120	5	Vrac gencodé	1

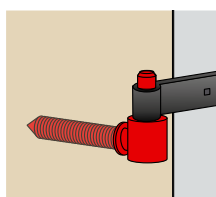

Gond à visser inox + axe laiton

Code	Gencod		D	L	Type packaging	
0162800	3308181628004	INOX 316L	14	93	Vrac gencodé	1
0708200	3308187082008	INOX 316L	16	93	Vrac gencodé	1

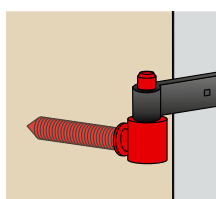
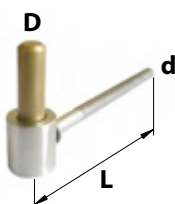

Gond à scellement chimique inox + axe laiton

Code	Gencod		D	d	L	Type packaging	
0708300	3308187083005	INOX 316L	16	M10	140	Vrac gencodé	1

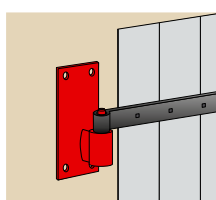
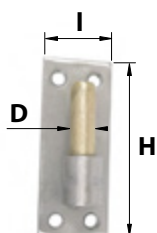

Gond platine inox bout carré + axe laiton

Code	Gencod		D	I	H	Ep.	Type packaging	
0162700	3308181627007	INOX 316L	14	40	100	4	Vrac gencodé	1
0694600	3308186946004	INOX 316L	16	40	180	5	Vrac gencodé	1



La mise en œuvre des fermetures est encadrée par le DTU 34-4, s'y référer pour éviter tout danger.

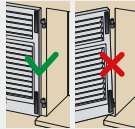

Bien s'assurer que le vantail soit monté plaqué et serré sur la façade.



En cas de vent, fermer les volets.



Pour les volets de grandes tailles, utiliser uniquement les arrêts adaptés



Conseils de pose P.133



Plus d'infos sur www.afbat.com

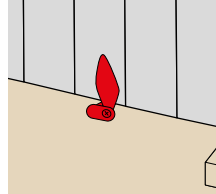
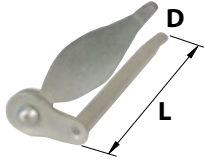

Tourniquet marseillais inox à sceller *

Code	Gencod		D	L	Type packaging	
0423900	3308184239009	INOX 316L	10	120	Vrac gencodé	1

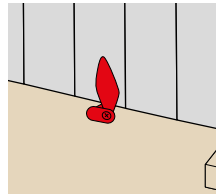
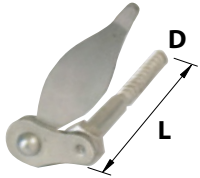

Tourniquet marseillais inox à visser *

Code	Gencod		D	L	Type packaging	
0163400	3308181634005	INOX 316L	10	110	Vrac gencodé	1

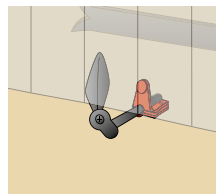
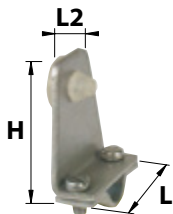

Butée tourniquet marseillais inox (x2)

Code	Gencod		L	L2	H	Ep.	Type packaging	
0955800	3308189558006	INOX 316L	35	18	43	2,5	Brochable gencodé	1

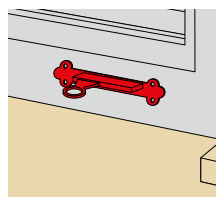
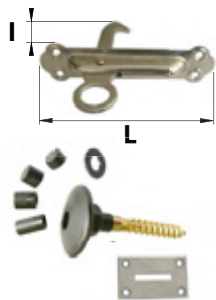

Arrêt de volet à ressort autobloquant inox *

Code	Gencod		L	I	Ep.	Type packaging	
0954700	3308189547000	INOX 304L	150	40	2	Brochable gencodé	1

Composition

1 arrêt à ressort - 1 gâche butée + 1 cheville - 1 rondelle - 4 tampons de réglage

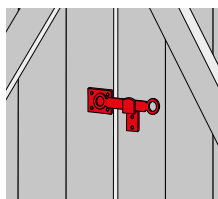
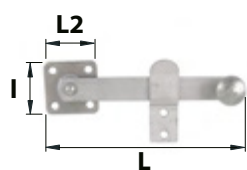

Poignée de fléau inox + support inox

Code	Gencod		L	L2	I	Type packaging	
0170700	3308181707006	INOX 316L	150	45	45	Vrac gencodé	1

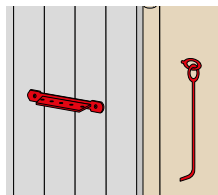

Crochet + crémaillère inox

Code	Gencod		D	L	Type packaging	
0171000	3308181710006	INOX 316L	8	300	Vrac gencodé	1

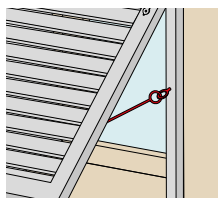
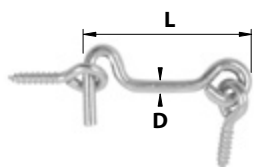

Crochet de contrevent + pitons inox

Code	Gencod		D	L	Type packaging	
8178060	3308181780603	INOX 304L	4	60	Vrac gencodé	1
8178100	3308181781006	INOX 304L	4,5	100	Vrac gencodé	1
8178160	3308181781600	INOX 304L	5	160	Vrac gencodé	1

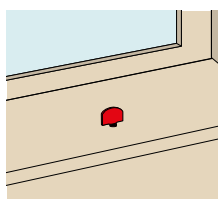
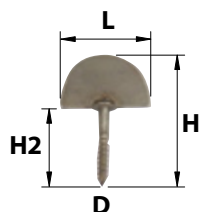

Butée de volet inox à vis

Code	Gencod		D	H	H2	L	Type packaging	
0170600	3308181706009	INOX 316L	5	59	35	39	Vrac gencodé	1

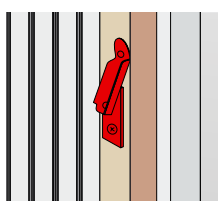
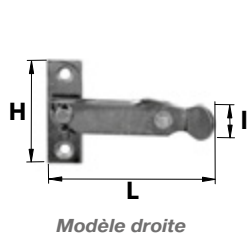

Arrêt de persienne inox à visser + butée

Code	Gencod		L	I	H	Ep.	Type packaging	
Modèle droite								
0960500	3308189605007	INOX 304L	113,5	21	62	2	Vrac gencodé	1
Modèle gauche								
0960600	3308189606004	INOX 304L	113,5	21	62	2	Vrac gencodé	1

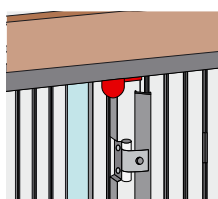
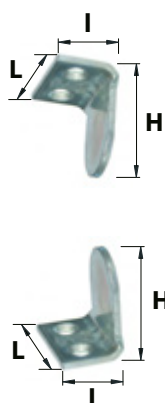

Butée de persienne inox à visser

Code	Gencod		L	I	H	Ep.	Type packaging	
Modèle haut								
0962703	3308189627030	INOX 304L	30	20	30,5	2	Brochable gencodé	1
Modèle bas								
0961403	3308189614030	INOX 304L	30	20	40	2	Brochable gencodé	1

Poignées

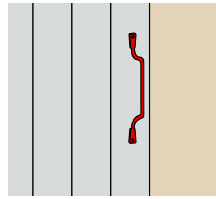
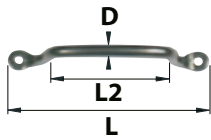

Poignée fil à pattes inox

Code	Gencod		D	L	L2	Type packaging	
0170800	3308181708003	INOX 316L	8	166	94	Vrac gencodé	1

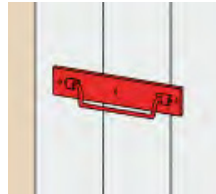

Poignée sur platine inox bouts carrés

Code	Gencod		L	Type packaging	
795214	3026727952146	INOX 304L	140	Vrac gencodé	4

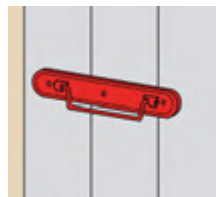

Poignée sur platine inox bouts ronds

Code	Gencod		L	Type packaging	
0170900	3308181709000	INOX 316L	140	Vrac gencodé	1

Esse

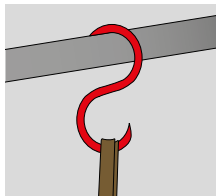
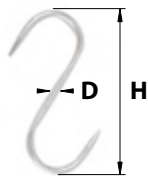

Esse de boucher inox

Code	Gencod		D	H	Type packaging	
671008	3026726710082	INOX 304L	4	80	Vrac gencodé	10
671012	3026726710129	INOX 304L	5	120	Vrac gencodé	10
671016	3026726710167	INOX 304L	6	160	Vrac gencodé	10

Sabots

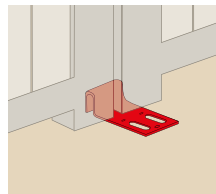
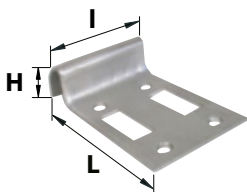

Sabot de portail inox à visser

Code	Gencod		L	I	H	Nb trous & Øvis	Type packaging	
0166300	3308181663005	INOX 316L	140	80	33	4xØ7,5	Vrac gencodé	1

Visserie non fournie.

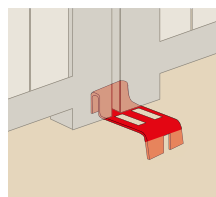
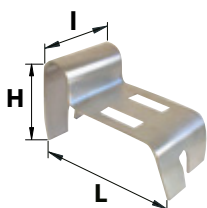

Sabot de portail inox à sceller

Code	Gencod		L	I	H	Type packaging	
0164400	3308181644004	INOX 316L	145	80	95	Vrac gencodé	1

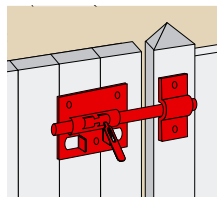
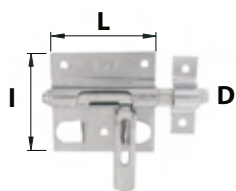

Verrou de box porte-cadenas inox à visser + gâche inox

Code	Gencod		D	L	I	Ep.	Type packaging	
857210	3026728572107	INOX 304L	10	105	63,5	1	Vrac gencodé	4

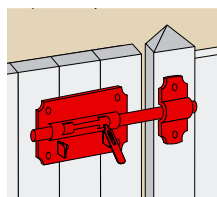
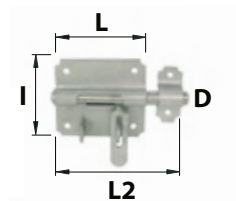

Verrou de box porte-cadenas inox à visser + gâche inox

Code	Gencod		D	L	L2	I	Ep.	Type packaging	
206002	3221682060022	INOX 316L	12	80	120	61	1,5	Vrac gencodé	1
2060014	3221682060015	INOX 316L	14	90	140	71	1,5	Vrac gencodé	1

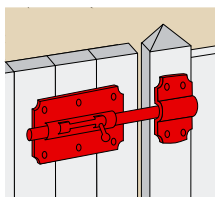
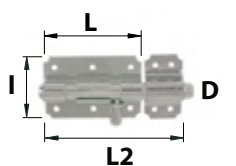

Verrou de box inox à visser + gâche inox

Code	Gencod		D	L	L2	I	Ep.	Type packaging	
206001	3221682060008	INOX 316L	10	65	100	48	1,5	Vrac gencodé	1
205012	3221682050122	INOX 316L	12	80	120	61	1,5	Vrac gencodé	1
2050014	3221682050016	INOX 316L	14	90	140	71	1,5	Vrac gencodé	1

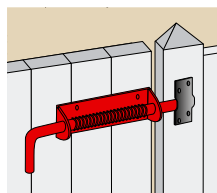
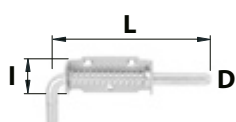

Verrou pistolet inox à ressort

Code	Gencod		D	L	I	Ep.	Type packaging	
861214	3026728612148	INOX 304L	14	187	30	3	Vrac gencodé	5

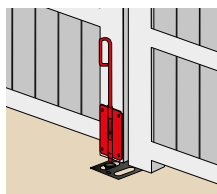
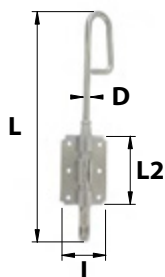

Verrou baïonnette inox à visser

Code	Gencod		D	L	L2	I	Ep.	Nb trous & Øvis	Type packaging	
2014250	3221682014254	INOX 316L	14	250	90	62	1,5	6xØ5	Vrac gencodé	1
2014300	3221682014308	INOX 316L	14	300	90	62	1,5	6xØ5	Vrac gencodé	1
2014400	3221682014407	INOX 316L	14	400	90	62	1,5	6xØ5	Vrac gencodé	1



L'EXTÉRIEUR DE L'HABITAT

LA PORTE EXTÉRIEURE

Sécurité

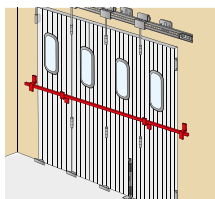

Barre de sécurité garage

Code	Gencod		L	Type packaging	
Réglable de 1800 à 3000 mm					
0739803	3308180026320	Z.BLANC	1800/3000		1

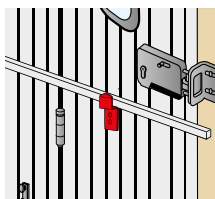

Support de barre de garage (x2)

Code	Gencod		H	I	Ep.	Type packaging	
0711803	3308187118035	Z.BLANC	95	35	5	Brochable gencodé	1
0249703	3308182497036	Z.BLANC	95	35	5		10

Hublots

RETROUVEZ NOS GRILLES DE HUBLOT
P.241 - GAMME GRILLES

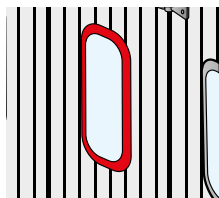

Hublot rectangulaire

Code	Gencod		L	I	Type packaging	
105031	3221681050314		342	210	Brochable gencodé	1
105036	3221681050369		342	210	Brochable gencodé	1
105041	3221681050413		342	210	Brochable gencodé	1

Charnières

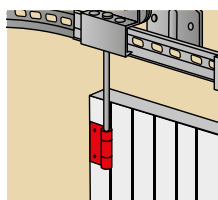
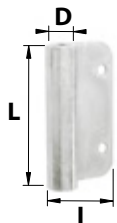

Charnière d'extrémité sur chant

Code	Gencod		D	L	I	Type packaging	
177005	3221681770052	Z.BLANC	12	80	42	Brochable gencodé	1

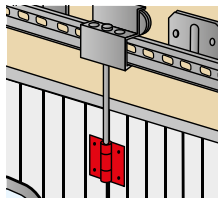
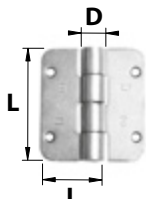

Charnière d'extrémité sur chant + axe

Code	Gencod		D	L	I	Type packaging	
177003	3221681770038	Z.BLANC	12	80	73	Brochable gencodé	1

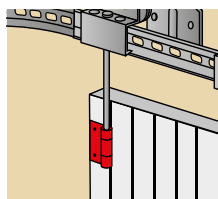
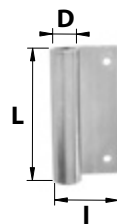

Charnière d'extrémité sur chant bouts carrés

Code	Gencod		D	L	I	Type packaging	
177006	3221681770069	Z.BLANC	12	80	42	Brochable gencodé	1

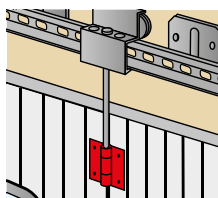
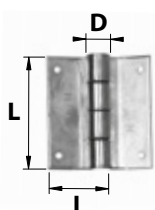

Charnière d'extrémité sur chant bouts carrés + axe

Code	Gencod		D	L	I	Type packaging	
177004	3221681770045	Z.BLANC	12	80	67	Brochable gencodé	1

Gâches

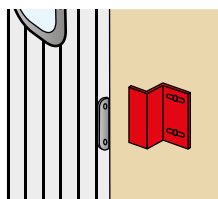
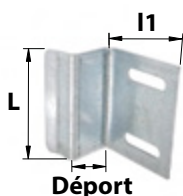

Gâche d'arrêt

Code	Gencod		L	I1	Déport	Ep.	Type packaging	
177012	3221681770120	Z.BLANC	72	63	26	5	Vrac gencodé	1

Rails

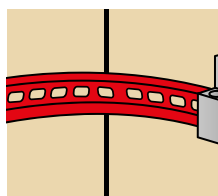
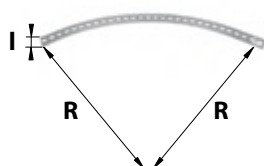

Rail courbe rayon 500 mm

Code	Gencod		R	I	Type packaging	
177017	3221681770175	GALVA	500	40	Vrac gencodé	1

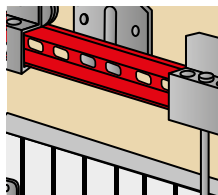

Rail droit

Code	Gencod		L	I	Type packaging	
177016	3221681770168	GALVA	1500	40	Vrac gencodé	1

Chariots

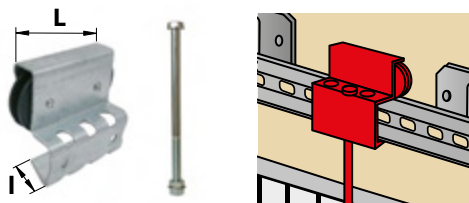

Chariot + boulon

Code	Gencod		L	I	Déport	Type packaging	
9177002	3221681770021	GALVA	105	49	28	Brochable gencodé	1

Accessoires de rail

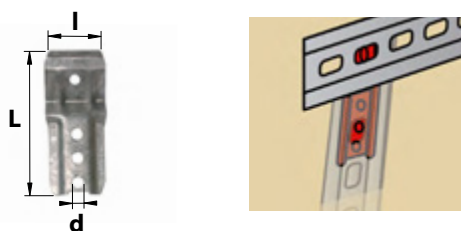

Support de courbe

Code	Gencod		L	I	d	Type packaging	
177011	3221681770113	GALVA	94	40	7	Vrac gencodé	1

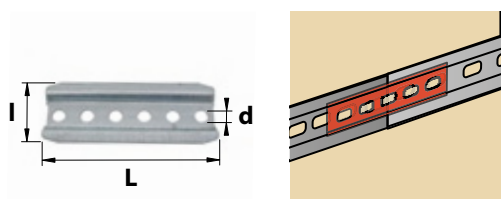

Raccord de rail

Code	Gencod		L	I	d	Type packaging	
177018	3221681770182	GALVA	92	36	7	Vrac gencodé	1

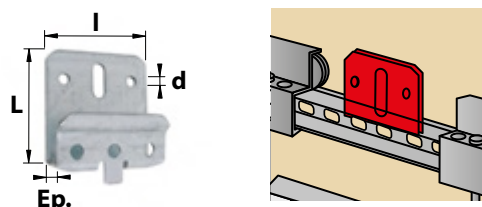

Bride de fixation

Code	Gencod		L	I	d	Ep.	Type packaging	
Déport 20 mm								
177008	3221681770083	Z.BLANC	64	60	7	20	Vrac gencodé	1
Déport 40 mm								
177009	3221681770090	Z.BLANC	64	60	7	40	Vrac gencodé	1

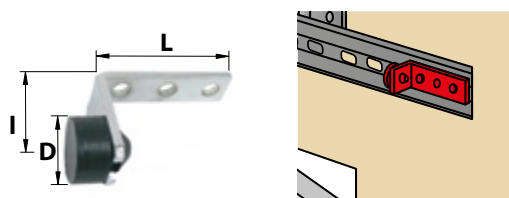

Arrêteur de fin de course

Code	Gencod		D	L	I	Type packaging	
177010	3221681770106	GALVA	25	62	32	Vrac gencodé	1

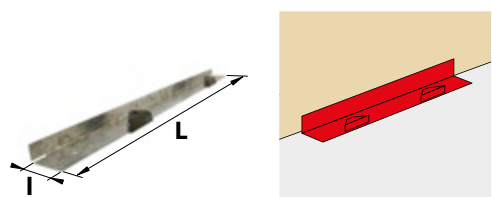

Seuil de retour avec demi-sabot

Code	Gencod		L	I	Type packaging	
177015	3221681770151	GALVA	800	49	Vrac gencodé	1

Sabots

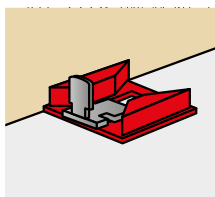

Sabot de guidage

Code	Gencod		L	I	H	Ep.	Autre	Type packaging	
177013	3221681770137	GALVA.	81	78	26	2	2xø6	Vrac gencodé	1

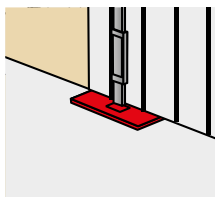

Demi-sabot de verrou

Code	Gencod		L	I	H	Ep.	Autre	Type packaging	
177014	3221681770144	GALVA.	76	75	26	2	2xø6	Vrac gencodé	1

Serrures

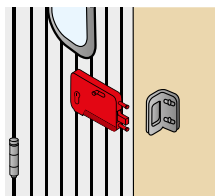

Serrure plate

Code	Gencod		L	I	Ep.	Type packaging	
Sans cylindre							
0996300	3308189963008		150	108	19	Brochable gencodé	1
Avec cylindre							
0996400	3308189964005		150	108	19	Brochable gencodé	1

Poignées

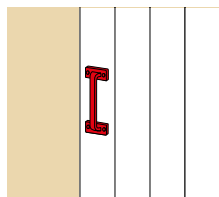

Poignée de porte de garage

Code	Gencod		L	I	Type packaging	
0634900	3308186349003		171	60	Vrac gencodé	1
105055	3221681050550		171	60	Vrac gencodé	1
0635000	3308186350009		171	60	Vrac gencodé	1

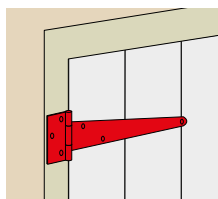
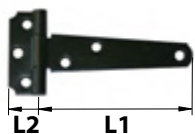

Penture anglaise légère

Code	Gencod		L1	L2	Ep.	Type packaging	
0503401	3308185034016		75	20,5	1,5	Vrac gencodé	10
0503501	3308185035013		100	20,5	1,5	Vrac gencodé	10
0095704	3308180957044		125	20,5	1,5	Vrac gencodé	10
0503402	3308185034023	Z.BLANC	75	20,5	1,5	Vrac gencodé	10
0503502	3308185035020	Z.BLANC	100	20,5	1,5	Vrac gencodé	10
0095702	3308180957020	Z.BLANC	125	20,5	1,5	Vrac gencodé	10
0503602	3308185036027	Z.BLANC	150	43,7	1,5	Vrac gencodé	10
0240802	3308182408025	Z.BLANC	75	20,5	1,5		50
0240902	3308182409022	Z.BLANC	100	20,5	1,5		30
0241002	3308182410028	Z.BLANC	125	20,5	1,5		50
0330302	3308183303022	Z.BLANC	150	43,7	1,5		20

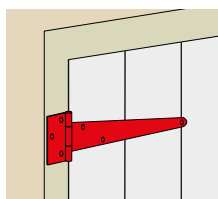
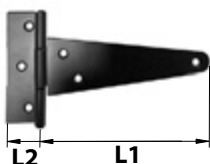

Penture anglaise

Code	Gencod		L1	L2	Ep.	Type packaging	
9624100	3479046241000		80	25	1,5	Vrac gencodé	10
624105	3479046241055		100	25	1,5	Vrac gencodé	10
624110	3479046241109		120	25	1,5	Vrac gencodé	10
624115	3479046241154		150	25	1,5	Vrac gencodé	10
624090	3479046240904	Z.BLANC	80	25	1,5	Vrac gencodé	10
1902102	3479046240911	Z.BLANC	100	25	1,5	Vrac gencodé	10
624092	3479046240928	Z.BLANC	120	25	1,5	Vrac gencodé	10

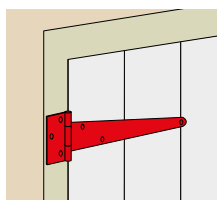

Penture anglaise

Code	Gencod		L1	L2	Ep.	Type packaging	
624155	3479046241550		200	42,7	2	Vrac gencodé	10
624160	3479046241604		250	42,7	2	Vrac gencodé	10
624165	3479046241659		300	42,7	2	Vrac gencodé	10
624170	3479046241703		350	42,7	2	Vrac gencodé	10
624094	3479046240942	Z.BLANC	200	42,7	2	Vrac gencodé	10
624095	3479046240959	Z.BLANC	250	42,7	2	Vrac gencodé	10
624096	3479046240966	Z.BLANC	300	42,7	2	Vrac gencodé	10
624070	3479046240706	Z.BLANC	350	42,7	2	Vrac gencodé	10
0241102	3308182411025	Z.BLANC	200	42,7	2		20
0241202	3308182412022	Z.BLANC	300	42,7	2		30

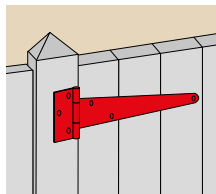

Penture anglaise forte

Code	Gencod		L1	L2	Ep.	Type packaging	
8207015	3221688207018		150	41,7	2,5	Vrac gencodé	10
8207020	3221688207216		200	41,7	2,5	Vrac gencodé	10
8207025	3221688207261		250	41,7	2,5	Vrac gencodé	10
8207030	3221688207315		300	41,7	2,5	Vrac gencodé	10
8207035	3221688207353		350	41,7	2,5	Vrac gencodé	10
8207040	3221688207407		400	41,7	2,5	Vrac gencodé	10
8207050	3221688207506		500	41,7	2,5	Vrac gencodé	10
8207060	3221688207605		600	41,7	2,5	Vrac gencodé	10
7207150	3221687207156	Z.BLANC	150	41,7	2,5	Vrac gencodé	10
7207200	3221687207200	Z.BLANC	200	41,7	2,5	Vrac gencodé	10
7207250	3221687207255	Z.BLANC	250	41,7	2,5	Vrac gencodé	10
7207300	3221687207309	Z.BLANC	300	41,7	2,5	Vrac gencodé	10
7207350	3221687207354	Z.BLANC	350	41,7	2,5	Vrac gencodé	10
7207400	3221687207408	Z.BLANC	400	41,7	2,5	Vrac gencodé	10
7207500	3221687207507	Z.BLANC	500	41,7	2,5	Vrac gencodé	10
7207600	3221687207606	Z.BLANC	600	41,7	2,5	Vrac gencodé	10
0465202	3308184652020	Z.BLANC	400	41,7	2,5		15
0465502	3308184655021	Z.BLANC	500	41,7	2,5		15
0465602	3308184656028	Z.BLANC	600	41,7	2,5		15

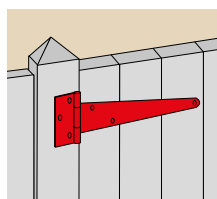
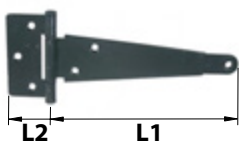

Penture anglaise avec axe composite

Code	Gencod		L1	L2	Ep.	Type packaging	
756915	3026727569153		144	45	2	Vrac gencodé	5
756920	3026727569207		194	45	2	Vrac gencodé	5
756925	3026727569252		244	45	2	Vrac gencodé	5
757930	3026727579305		292,8	45	2	Vrac gencodé	5
757935	3026727579350		342,8	45	2	Vrac gencodé	5
757940	3026727579404		392,8	45	2	Vrac gencodé	5
757950	3026727579503		492,8	45	2	Vrac gencodé	5
757960	3026727579602		572,8	45	2	Vrac gencodé	5
756815	3026727568156	Z.BLANC	144	45	2	Vrac gencodé	5
756820	3026727568200	Z.BLANC	194	45	2	Vrac gencodé	5
756825	3026727568255	Z.BLANC	244	45	2	Vrac gencodé	5
757830	3026727578308	Z.BLANC	292,8	45	2	Vrac gencodé	5
757835	3026727578353	Z.BLANC	342,8	45	2	Vrac gencodé	5
757840	3026727578407	Z.BLANC	392,8	45	2	Vrac gencodé	5
757850	3026727578506	Z.BLANC	492,8	45	2	Vrac gencodé	5
757860	3026727578605	Z.BLANC	572,8	45	2	Vrac gencodé	5

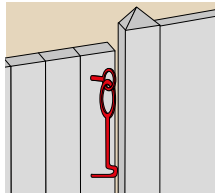
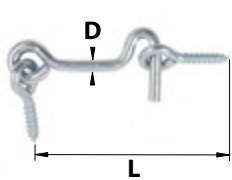

Crochet contrevent + pitons

Code	Gencod		D	L	Type packaging	
Sachet de 2 unités						
6177005	3221686177009	Z.BLANC	4	50	Vrac gencodé	10
6177060	3221686177061	Z.BLANC	4	60	Vrac gencodé	10
6177080	3221686177085	Z.BLANC	4	80	Vrac gencodé	10
6177100	3221686177108	Z.BLANC	5	100	Vrac gencodé	10
6177120	3221686177122	Z.BLANC	5	120	Vrac gencodé	10
6177140	3221686177146	Z.BLANC	6	140	Vrac gencodé	10
6177160	3221686177160	Z.BLANC	6	160	Vrac gencodé	10
6177180	3221686177184	Z.BLANC	6	180	Vrac gencodé	10
6177200	3221686177207	Z.BLANC	6	200	Vrac gencodé	10
0494802	3308184948024	Z.BLANC	8	300	Vrac gencodé	10
0494902	3308184949021	Z.BLANC	8	400	Vrac gencodé	10
0495002	3308184950027	Z.BLANC	8	500	Vrac gencodé	10
0245402	3308182454022	Z.BLANC	4	50		100
0245502	3308182455029	Z.BLANC	4	80		100
0245602	3308182456026	Z.BLANC	5	100		100
0245702	3308182457023	Z.BLANC	5	120		50
0245802	3308182458020	Z.BLANC	6	140		50
0245902	3308182459027	Z.BLANC	6	160		50
0246002	3308182460023	Z.BLANC	6	180		50
0246102	3308182461020	Z.BLANC	6	200		50

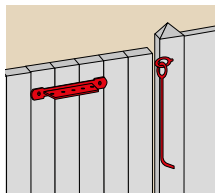

Crochet + crémaillère à poignée

Code	Gencod		D	L	Type packaging	
0491103	3308184911035	Z.BLANC	8	300	Vrac gencodé	10
503476	3479045034764	Z.BLANC	8	350	Vrac gencodé	10
0491003	3308184910038	Z.BLANC	8	400	Vrac gencodé	10
0812403	3308180038514	Z.BLANC	8	500	Vrac gencodé	10
503480	3479045034801	Z.BLANC	8	600	Vrac gencodé	10



L'EXTÉRIEUR DE L'HABITAT

LA SÉCURITÉ
LA SÉCURITÉ

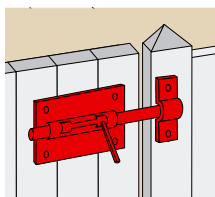
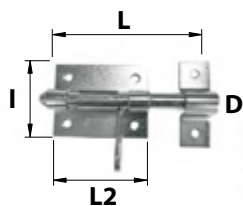

Verrou de box à visser + gâche

Code	Gencod		D	L	L2	I	Ep.	Type packaging	
0163911	3308180046366		8	80	60	48	1	Vrac gencodé	5
0164011	3308180046373		10	100	70	52	1	Vrac gencodé	5
0164111	3308180046380		12	116	80	60	1	Vrac gencodé	5
0164211	3308180046397		14	130	90	66	1	Vrac gencodé	5
0164301	3308181643014		16	135	95	67	1	Vrac gencodé	5
0163902	3308181639024	Z.BLANC	8	80	60	48	1	Vrac gencodé	5
0164002	3308181640020	Z.BLANC	10	100	70	52	1	Vrac gencodé	5
0164102	3308181641027	Z.BLANC	12	116	80	60	1	Vrac gencodé	5
0164202	3308181642024	Z.BLANC	14	130	90	66	1	Vrac gencodé	5
0164302	3308181643021	Z.BLANC	16	135	95	67	1	Vrac gencodé	5
0258802	3308182588024	Z.BLANC	8	80	60	48	1		50
0258402	3308182584026	Z.BLANC	10	100	70	52	1		20
0258702	3308182587027	Z.BLANC	12	116	80	60	1		20
0258902	3308182589021	Z.BLANC	14	130	90	66	1		10
0259202	3308182592021	Z.BLANC	16	135	95	67	1		10

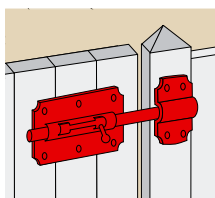
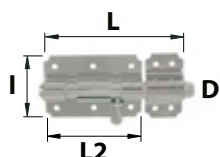

Verrou de box inox à visser + gâche inox

Code	Gencod		D	L	L2	I	Ep.	Type packaging	
206001	3221682060008	INOX 316 L	10	100	65	48	1,5	Vrac gencodé	1
205012	3221682050122	INOX 316 L	12	120	80	58	1,5	Vrac gencodé	1
2050014	3221682050016	INOX 316 L	14	140	90	61	1,5	Vrac gencodé	1

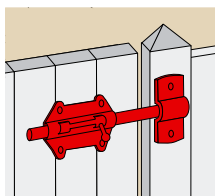
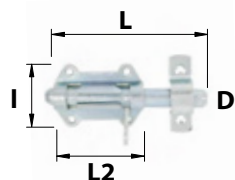

Verrou de box maxi à visser

Code	Gencod		D	L	L2	I	Ep.	Type packaging	
854016	3026728540168	Z.BLANC	16	145	82	60	3	Vrac gencodé	5

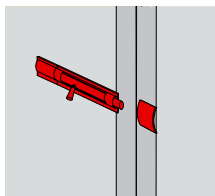
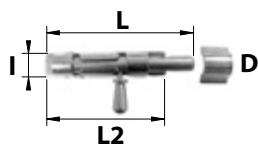

Verrou de box à visser

Code	Gencod		D	L	L2	I	Ep.	Type packaging	
0361103	3308183611035	Z.BLANC	16	150	131	26	3,5	Vrac gencodé	1

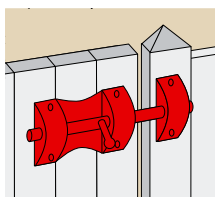
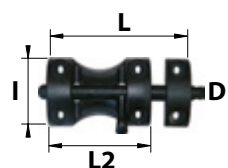

Verrou de box composite à visser cadenassable + gâche

Code	Gencod		D	L	L2	I	Ep.	Type packaging	
856514	3026728565147		14	145	89	60	30	Brochable gencodé	5

Verrou de box porte-cadenas + gâche

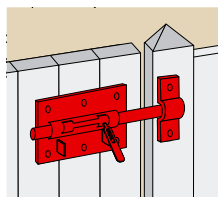
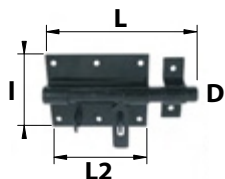

Code	Gencod		D	L	L2	I	Ep.	Type packaging	
0164611	3308180046502		10	100	70	66	1	Vrac gencodé	5
0164711	3308180046403		12	116	80	68	1	Vrac gencodé	5
0164811	3308180046410		14	130	90	73	1	Vrac gencodé	5
0694900	3308186949005		16	135	95	80	1	Vrac gencodé	5
0165011	3308181650111		18	135	95	82	1	Vrac gencodé	5
0164602	3308181646022	Z.BLANC	10	100	70	66	1	Vrac gencodé	5
0164702	3308181647029	Z.BLANC	12	116	80	68	1	Vrac gencodé	5
0164802	3308181648026	Z.BLANC	14	130	90	73	1	Vrac gencodé	5
0164902	3308181649023	Z.BLANC	16	135	95	80	1	Vrac gencodé	5
0165002	3308181650029	Z.BLANC	18	135	95	82	1	Vrac gencodé	5
0242502	3308182425022	Z.BLANC	10	100	70	66	1		20
0242702	3308182427026	Z.BLANC	12	116	80	68	1		20
0242802	3308182428023	Z.BLANC	14	130	90	73	1		10
0242902	3308182429020	Z.BLANC	16	135	95	80	1		10

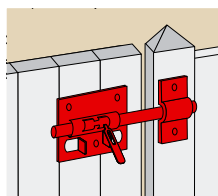
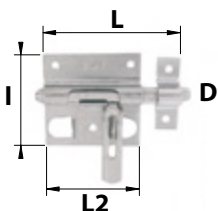

Verrou de box porte-cadenas inox à visser + gâche inox

Code	Gencod		D	L	L2	I	Ep.	Type packaging	
857210	3026728572107	INOX 304L	10	105	67	63,5	1	Vrac gencodé	4

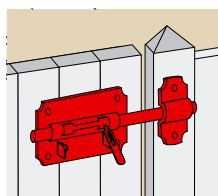
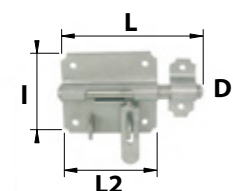

Verrou de box inox porte-cadenas + gâche

Code	Gencod		D	L	L2	I	Ep.	Type packaging	
206002	3221682060022	INOX 304L	12	120	80	58	1,5	Vrac gencodé	1
2060014	3221682060015	INOX 304L	14	140	90	58	1,5	Vrac gencodé	1

Verrou pistolet + gâche

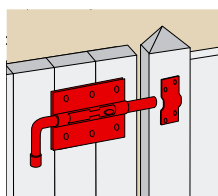
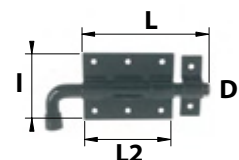

Code	Gencod		D	L	L2	I	Ep.	Type packaging	
524340	3479045243401		10	125	70	53	1	Vrac gencodé	5
524350	3479045243500		12	143	80	52	1	Vrac gencodé	5
524351	3479045243517		14	166	90	66	1	Vrac gencodé	5
524361	3479045243616		16	180	95	66	1	Vrac gencodé	5
522340	3479045223403	Z.BLANC	10	125	70	53	1	Vrac gencodé	5
522350	3479045223502	Z.BLANC	12	143	80	52	1	Vrac gencodé	5
522351	3479045223519	Z.BLANC	14	166	90	66	1	Vrac gencodé	5
522361	3479045223618	Z.BLANC	16	180	95	66	1	Vrac gencodé	5
0941201	3308189412018		16	180	95	66	1		10
0457001	3308184570010		12	143	80	52	1		20

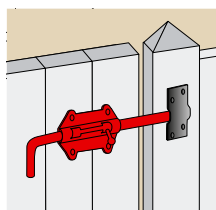
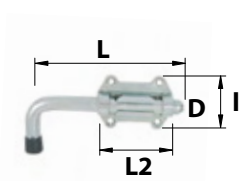

Verrou pistolet maxi à visser

Code	Gencod		D	L	L2	I	Ep.	Type packaging	
854017	3026728540175	Z.BLANC	16	170	82	25	3	Vrac gencodé	5

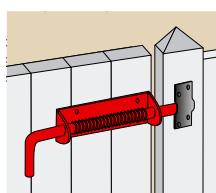
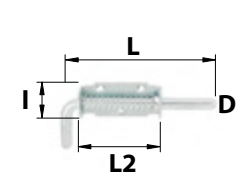

Verrou pistolet à ressort

Code	Gencod		D	L	L2	I	Ep.	Type packaging	
861810	3026728618102	Z.BLANC	10	132	68	30	2	Vrac gencodé	10
861812	3026728618126	Z.BLANC	12	185	90	40	3	Vrac gencodé	10
0166402	3308181664026	Z.BLANC	14	190	92	40	3	Vrac gencodé	5

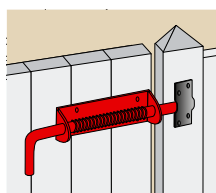
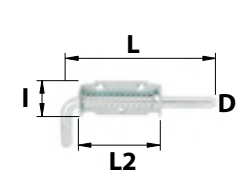

Verrou pistolet inox à ressort

Code	Gencod		D	L	L2	I	Ep.	Type packaging	
861214	3026728612148	INOX 304L	14	187	92	40	2,5	Vrac gencodé	5

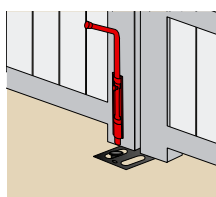
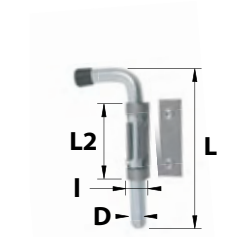

Verrou de pied universel + platine à souder

Code	Gencod		D	L	L2	I	Ep.	Type packaging	
854117	3026728541172	Z.BLANC	16	170	82	25	3	Vrac gencodé	5

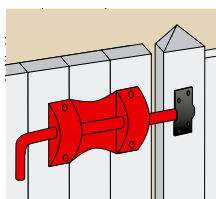
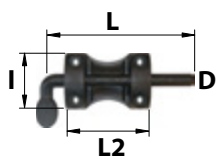

Verrou pistolet composite + gâche

Code	Gencod		D	L	L2	I	Ep.	Type packaging	
859514	3026728595144		14	169	89	60	30	Brochable gencodé	5

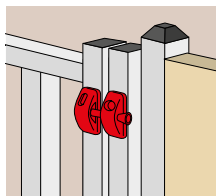

Verrou magnétique anticorrosion

Code	Gencod		L	I	Ep.	Type packaging	
0958400	3308189584005		95	55	14	Brochable gencodé	1

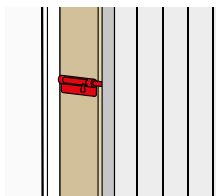

Verrou rond

Code	Gencod		D	L	H	Type packaging	
0938000	3308189380003		10	110	35		10

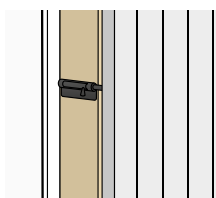
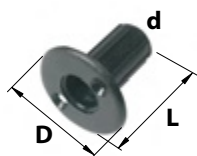

Gâche de verrou rond à encastrer

Code	Gencod		D	d	L	Type packaging	
0936000	3308189360005		30	11	27		10

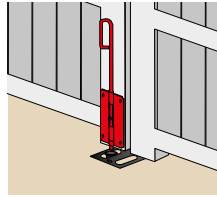
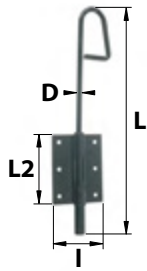

Verrou baionnette à visser

Code	Gencod		D	L	L2	I	Ep	Nb trous & Øvis	Type packaging	
0725311	3308180046298		12	200	80	60	1	4xØ5	Vrac gencodé	5
9524006	3479045240066		12	242	80	60	1	4xØ5	Vrac gencodé	5
524010	3479045240103		14	250	90	66	1	6xØ5	Vrac gencodé	5
0725411	3308180046311		14	305	90	66	1	6xØ5	Vrac gencodé	5
0725511	3308180046328		14	398	90	66	1	6xØ5	Vrac gencodé	5
524041	3479045240417		16	405	90	67	1	6xØ5	Vrac gencodé	5
0725611	3308180046335		16	502	95	67	1	6xØ5	Vrac gencodé	5
0725302	3308187253026	Z.BLANC	12	200	80	60	1	4xØ5	Vrac gencodé	5
522006	3479045220068	Z.BLANC	12	242	80	60	1	4xØ5	Vrac gencodé	5
522010	3479045220105	Z.BLANC	14	250	90	66	1	6xØ5	Vrac gencodé	5
0725402	3308187254023	Z.BLANC	14	305	90	66	1	6xØ5	Vrac gencodé	5
0725502	3308187255020	Z.BLANC	14	398	90	66	1	6xØ5	Vrac gencodé	5
522041	3479045220419	Z.BLANC	16	405	90	67	1	6xØ5	Vrac gencodé	5
0725602	3308187256027	Z.BLANC	16	502	95	67	1	6xØ5	Vrac gencodé	5
0246702	3308182467022	Z.BLANC	12	200	80	60	1	4xØ5		20
0246902	3308182469026	Z.BLANC	14	305	90	66	1	6xØ5		10
0465702	3308184657025	Z.BLANC	14	398	90	66	1	6xØ5		20

Avec gâche

0725711	3308180046342		16	605	95	67	1	6xØ5	Vrac gencodé	5
524071	3479045240714		18	605	95	65	1	6xØ5	Vrac gencodé	5
524081	3479045240813		18	800	95	65	1	6xØ5	Vrac gencodé	5
0725702	3308187257024	Z.BLANC	16	605	95	67	1	6xØ5	Vrac gencodé	5
860886	3026728608868	Z.BLANC	18	605	95	65	1	6xØ5	Vrac gencodé	5
522081	3479045220815	Z.BLANC	18	800	95	65	1	6xØ5	Vrac gencodé	5

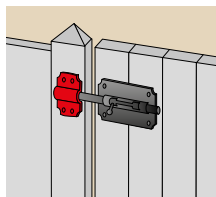
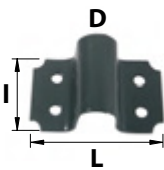

Gâche à visser

Code	Gencod		D	L	I	Ep	Nb trous & Øvis	Type packaging	
0166901	3308181669014		8	39	15	1	2xØ4,5	Vrac gencodé	10
0167011	3308180046458		10	45	20	1	2xØ4,5	Vrac gencodé	10
0167111	3308180046465		12	51	22	1	2xØ5	Vrac gencodé	10
0167211	3308180046472		14	60	35	1	4xØ5	Vrac gencodé	10
0167311	3308180046489		16	65	35	1	4xØ5	Vrac gencodé	10
8118001	3221688118000		18	66	35	1	4xØ5	Vrac gencodé	10
0166902	3308181669021	Z.BLANC	8	39	15	1	2xØ4,5	Vrac gencodé	10
0167002	3308181670027	Z.BLANC	10	45	20	1	2xØ4,5	Vrac gencodé	10
0167102	3308181671024	Z.BLANC	12	51	22	1	2xØ5	Vrac gencodé	10
0167202	3308181672021	Z.BLANC	14	60	35	1	4xØ5	Vrac gencodé	10
0167302	3308181673028	Z.BLANC	16	65	35	1	4xØ5	Vrac gencodé	10
0167402	3308181674025	Z.BLANC	18	66	35	1	4xØ5	Vrac gencodé	10
0441811	3308184418114		12	51	22	1	2xØ5		50
0441911	3308184419111		16	65	35	1	4xØ5		50
0417902	3308184179022	Z.BLANC	14	60	35	1	4xØ5		50

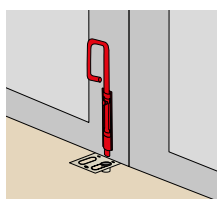
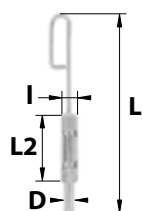

Verrou baïonnette à souder

Code	Gencod		D	L	L2	I	Ep	Type packaging	
7116003	3221687116038	Z.BLANC	16	300	100	25,5	3	Vrac gencodé	1
7116004	3221687116045	Z.BLANC	16	400	100	25,5	3	Vrac gencodé	1

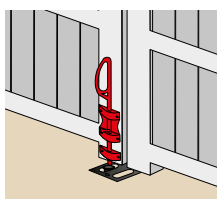
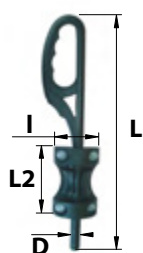

Verrou baïonnette composite à visser

Code	Gencod		D	L	L2	I	Ep	Type packaging	
860514	3026728605140		14	300	90	60	30	Brochable gencodé	5

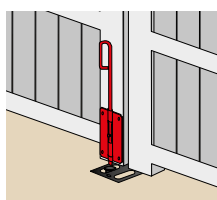
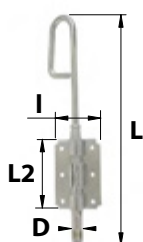

Verrou baïonnette inox à visser

Code	Gencod		D	L	L2	I	Ep	Nb trous & Øvis	Type packaging	
2014250	3221682014254	INOX 316 L	14	250	90	62	1,5	6xØ5	Vrac gencodé	1
2014300	3221682014308	INOX 316 L	14	300	90	62	1,5	6xØ5	Vrac gencodé	1
2014400	3221682014407	INOX 316 L	14	400	90	62	1,5	6xØ5	Vrac gencodé	1

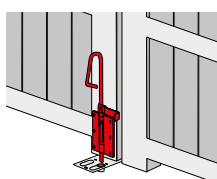
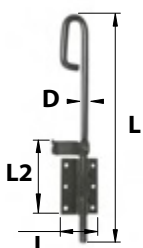

Verrou baïonnette de sécurité

Code	Gencod		D	L	L2	I	Ep	Nb trous & Øvis	Type packaging	
0359300	3308183593003		14	400	90	62	1,5	6xØ5	Vrac gencodé	1

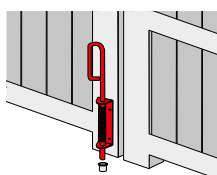
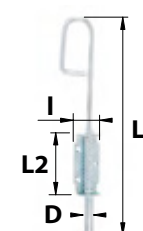

Verrou baïonnette à ressort

Code	Gencod		D	L	L2	I	Ep	Nb trous & Øvis	Type packaging	
863810	3026728638100	Z.BLANC	10	250	69,9	20	2	3xØ4,5	Vrac gencodé	10
0903902	3308189039024	Z.BLANC	14	250	71	40	3	4xØ6	Vrac gencodé	5

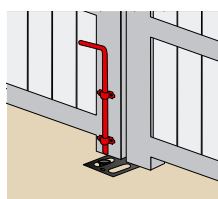
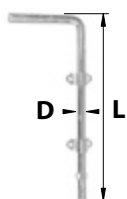

Verrou de sécurité

Code	Gencod		D	L	Type packaging	
0888003	3308188880030	Z.BLANC	14	270	Vrac gencodé	1

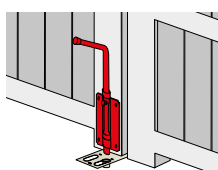
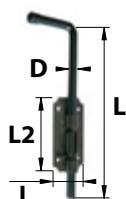

Verrou à tige cadennable

Code	Gencod		D	L	L2	I	Nb trous & Øvis	Type packaging	
0783304	3308187833044		16	300	130	60	4xØ6,5	Vrac gencodé	1
0942001	3308189420013		16	300	130	60	4xØ6,5		5

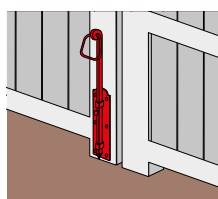
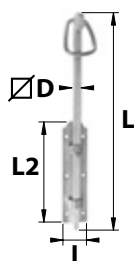

Verrou de barrière à boucle

Code	Gencod		ØD	L	L2	I	Ep	Nb trous & Øvis	Type packaging	
0166503	3308181665030	Z.BLANC	14	300	176	48	3	6xØ4,5	Vrac gencodé	1
0166803	3308181668031	Z.BLANC	14	400	176	48	3	6xØ4,5	Vrac gencodé	1

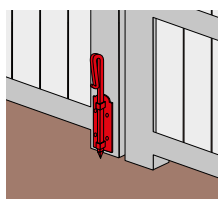

Verrou de barrière à crosse rustique

Code	Gencod		ØD	L	L2	I	Ep	Nb trous & Øvis	Type packaging	
0456601	3308184566013		14	300	176	48	3	6xØ4,5	Vrac gencodé	1
0243503	3308182435038	Z.BLANC	14	400	176	48	3	6xØ4,5		5

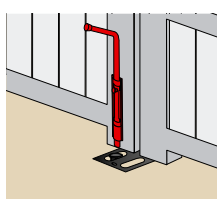
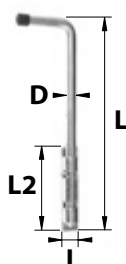

Verrou de pied universel à souder

Code	Gencod		D	L	L2	I	Ep	Type packaging	
0226003	3308182260036	Z.BLANC	16	300	131	26	3,5	Vrac gencodé	1

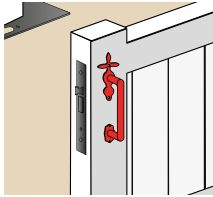

Loquet de porte à bascule avec poignée

Code	Gencod		Type packaging	
0450206	3308184502066		Vrac gencodé	1
692801	3026726928012	Z.BLANC	Vrac gencodé	1

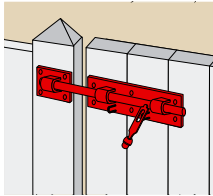
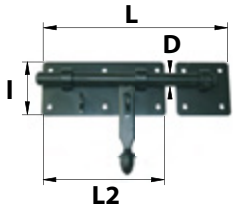

Verrou d'écurie porte-cadenas + gâche

Code	Gencod		D	L	L2	I	Ep.	Nb trous & Øvis	Type packaging	
0226101	3308182261019		18	230	160	65	3,5	10xØ6	Vrac gencodé	1
0226103	3308182261033	Z.BLANC	18	230	160	65	3,5	10xØ6	Vrac gencodé	1

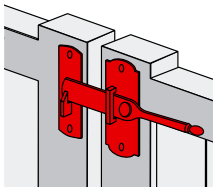
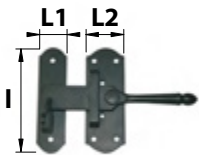

Clenche universelle

Code	Gencod		L1	L2	I	Nb trous & Øvis	Type packaging	
0108506	3308181085067		34	47,5	130	6xØ6	Vrac gencodé	1

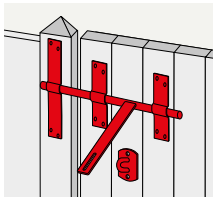
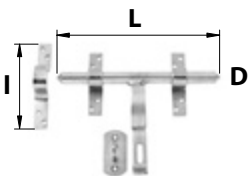

Verrou vervelle avec porte-cadenas et gâche

Code	Gencod		D	L	I	Ep.	Nb trous & Øvis	Type packaging	
0165602	3308181656021	Z.BLANC	14	200	150	2	12xØ5,5	Vrac gencodé	5
522386	3479045223861	Z.BLANC	16	200	150	2	12xØ5,5	Vrac gencodé	5

Loquets

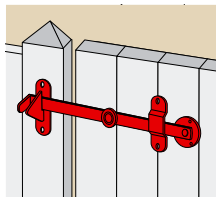

Loquet de sécurité cadenassable

Code	Gencod		L	I	Ep	Nb trous & Øvis	Type packaging	
0272001	3308182720011		200	80	4	3xØ5,3 4xØ6,2	Vrac gencodé	1

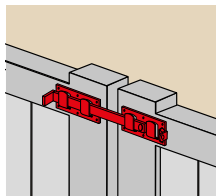
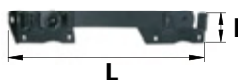

Fléau de portail

Code	Gencod		L	I	Ep	Type packaging	
168440	3026721684401		400	35	5	Vrac gencodé	5

Brides

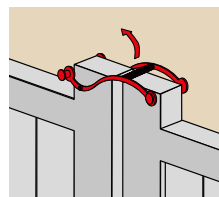

Bride de barrière

Code	Gencod		Type packaging	
870950	3026728709503		Vrac gencodé	1

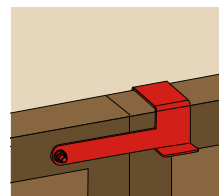

Verrou de barrière à bascule

Code	Gencod		L	I	I2	Type packaging	
0133029	3517651330297		250	80	45	Vrac gencodé	1

Verrou charnière

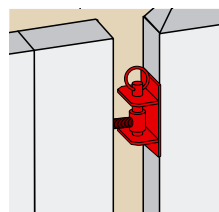
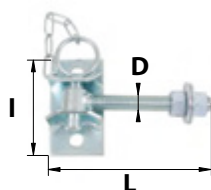

Verrou charnière à goupille

Code	Gencod		D	L	I	Ep.	Type packaging	
738060	3026727380604	Z.BLANC	14	140	55	3	Vrac gencodé	4

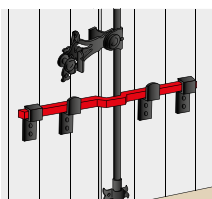
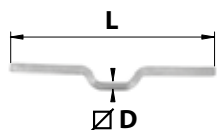

Barre de sécurité renforcée

Code	Gencod		Ø D	L	Type packaging	
0640903	3308186409035	Z.BLANC	16	410	Vrac gencodé	1
0705903	3308187059031	Z.BLANC	16	980	Vrac gencodé	1
0706003	3308187060037	Z.BLANC	16	1480	Vrac gencodé	1

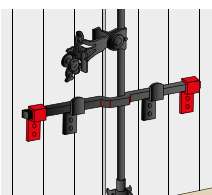
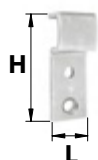

Support antisoulèvement barre de sécurité pour carré 16

Code	Gencod		L	H	Ep.	Type packaging	
(x1)							
0802103	3308180030778	Z.BLANC	25	69,5	3,5	Vrac gencodé	10
0247403	3308182474037	Z.BLANC	25	69,5	3,5		100
(x2)							
0711603	3308187116031	Z.BLANC	25	69,5	3,5	Brochable gencodé	1

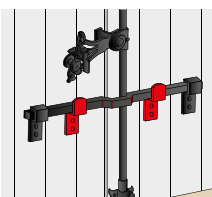
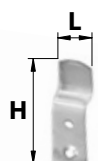

Support simple barre de sécurité pour carré 16

Code	Gencod		L	H	Ep.	Type packaging	
(x1)							
0801903	3308180030761	Z.BLANC	25	75	3,5	Vrac gencodé	10
0247503	3308182475034	Z.BLANC	25	75	3,5		100
Support simple (x2) + contre-plaque (x2)							
0711504	3308187115041		25	75	3,5	Brochable gencodé	1
0711503	3308187115034	Z.BLANC	25	75	3,5	Brochable gencodé	1
Support simple barre (x4) + visserie							
0409203	3308184092031	Z.BLANC	25	75	3,5	Brochable gencodé	1

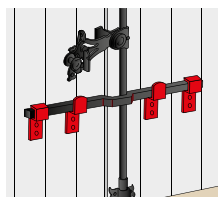

Kit support barre de sécurité pour carré 16

Code	Gencod		Type packaging	
Support simple (x2) + antisoulèvement (x2) + visserie				
0318104	3308183181040		Vrac gencodé	1
0318103	3308183181033	Z.BLANC	Vrac gencodé	1
Support simple (x2) + antisoulèvement (x2) + contre-plaques (x4) + visserie				
0409103	3308184091034	Z.BLANC	Brochable gencodé	1

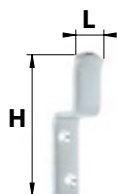

Support ouvert barre de sécurité

Code	Gencod		L	H	Type packaging	
Pour carré de 25 mm						
6139025	3221686139250	Z.BLANC	20	94	Vrac gencodé	10
Pour carré de 25 à 36 mm						
6139036	3221686139366	Z.BLANC	20	94	Vrac gencodé	10

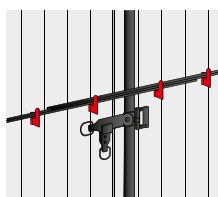
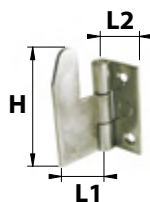

Support charnière pour barre de sécurité 12 mm

Code	Gencod		L1	L2	H	Ep.	Type packaging	
Modèle droite								
538130	3479045381301	Z.BLANC	34	23,5	67	2	Vrac gencodé	10
Modèle gauche								
538140	3479045381400	Z.BLANC	34	23,5	67	2	Vrac gencodé	10

Modèle droite

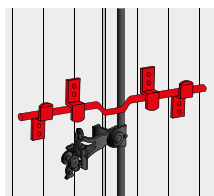
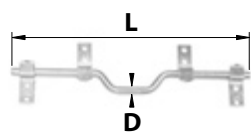

Barre de sécurité ronde

Code	Gencod		D	L	Type packaging	
0337103	3308183371038	Z.BLANC	14	410	Brochable gencodé	1

Composition
 1 barre de sécurité L410 mm
 4 supports droits
 Visserie

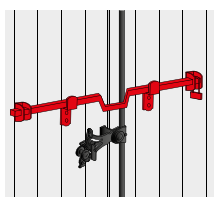
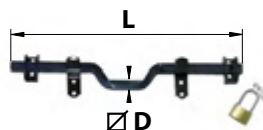

Barre de sécurité renforcée + cadenas

Code	Gencod		∅ D	L	Type packaging	
0337504	3308183375043		16	410	Brochable gencodé	1

Composition
 1 barre de sécurité L410 mm percée pour passage du cadenas
 2 supports droits + 2 supports sécurité
 1 cadenas
 Visserie

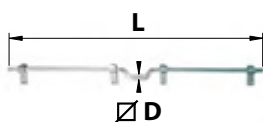
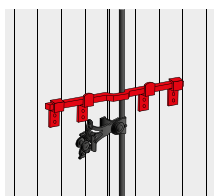
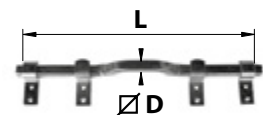

Barre de sécurité renforcée

Code	Gencod		∅ D	L	Type packaging	
0707004	3308180029949		16	410	Brochable gencodé	1
0802204	3308188022041		16	980	Brochable gencodé	1
0707003	3308187070036	Z.BLANC	16	410	Brochable gencodé	1
0802203	3308180029796	Z.BLANC	16	980	Brochable gencodé	1

Composition
 1 barre de sécurité
 2 supports simples
 2 supports anti-soulèvements
 4 contre-plaques (uniquement pour L980mm)
 Visserie

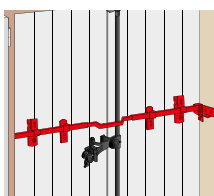

Barre de sécurité réglable 6 points

Code	Gencod		∅ D	L	Type packaging	
0704404	3308187044044		16	410	Brochable gencodé	1

Composition
 1 barre de sécurité L410 mm
 2 rallonges
 2 supports intermédiaires
 2 supports verrous
 2 supports tableau



Modèle
1 vantail

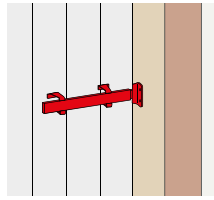

Barre de sécurité verrou

Code	Gencod		L	I	Type packaging	
1 vantail						
0337706	3308183377061		245	30	Brochable gencodé	1
2 vantaux						
0777406	3308180029802		245 + 245	30	Brochable gencodé	1

Composition

Pour 1 vantail :

- 1 fourreau avec pêne cadenasable
- 1 gâche murale à visser
- Visserie

Pour 2 vantaux :

- 1 fourreau avec pêne cadenasable
- 1 fourreau sans pêne
- Visserie

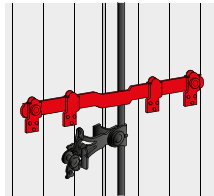

Barre de sécurité à boutons

Code	Gencod		L	Type packaging	
0318304	3308183183044		450	Brochable gencodé	1

Composition

- 1 barre de sécurité L450 mm
- 2 supports simples
- 2 supports antisoulèvement
- Visserie

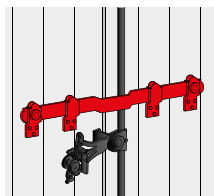
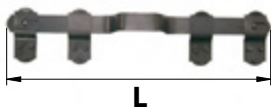

Barre de sécurité plate à ergots

Code	Gencod		L	Type packaging	
Acier					
0174403	3308181744032	Z.BLANC	450	Brochable gencodé	1
Aluminium					
0312906	3308183129066		450	Brochable gencodé	1
0312926	3308183129264		450	Brochable gencodé	1

Composition

- 1 barre de sécurité L450 mm
- 2 supports simples
- 2 supports antisoulèvement
- Visserie

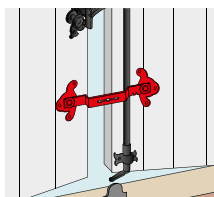
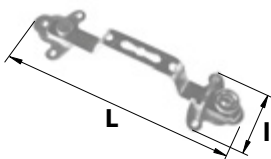

Entrebâilleur de sécurité

Code	Gencod		L	I	Tarif HT en €	Type packaging	
0700104	3308180040555		285	83	24,38	Brochable gencodé	1
0700103	3308187001030	Z.BLANC	285	83	24,38	Brochable gencodé	1
0942703	3308189427036	Z.BLANC	285	83	23,02		5



L'EXTÉRIEUR DE L'HABITAT

LES GRILLES

LES GRILLES

NOUVEAU

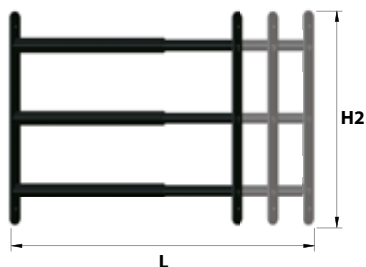
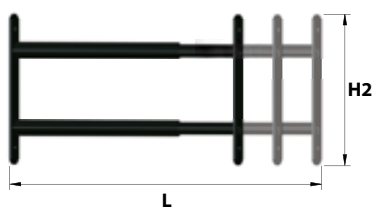
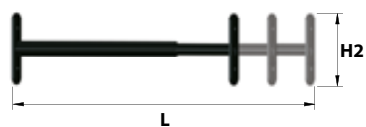
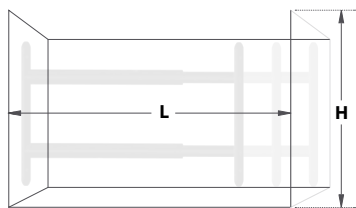

NOUVEAU

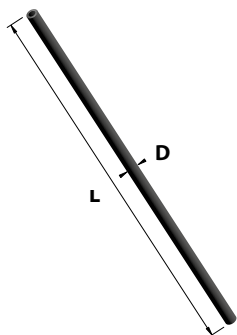

NOUVEAU

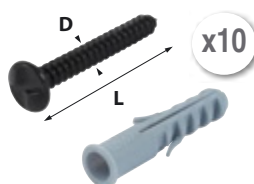

Grille de défense télescopique

Code	Gencod		L	H	H2	Type packaging	
1 barreau							
440301	3308184403011	9005 - 30%	300 à 550	130 à 260	125	Vrac gencodé	1
440551	3308184405510	9005 - 30%	550 à 1030	130 à 260	125	Vrac gencodé	1
440991	3308184409914	9005 - 30%	990 à 1880	130 à 260	125	Vrac gencodé	1
440305	3308184403059	7016	300 à 550	130 à 260	125	Vrac gencodé	1
440555	3308184405558	7016	550 à 1030	130 à 260	125	Vrac gencodé	1
440995	3308184409952	7016	990 à 1880	130 à 260	125	Vrac gencodé	1
2 barreaux							
440302	3308184403028	9005 - 30%	300 à 550	260 à 390	255	Vrac gencodé	1
440552	3308184405527	9005 - 30%	550 à 1030	260 à 390	255	Vrac gencodé	1
440992	3308184409921	9005 - 30%	990 à 1880	260 à 390	255	Vrac gencodé	1
440306	3308184403066	7016	300 à 550	260 à 390	255	Vrac gencodé	1
440556	3308184405565	7016	550 à 1030	260 à 390	255	Vrac gencodé	1
440996	3308184409969	7016	990 à 1880	260 à 390	255	Vrac gencodé	1
3 barreaux							
440303	3308184403035	9005 - 30%	300 à 550	390 à 520	385	Vrac gencodé	1
440553	3308184405534	9005 - 30%	550 à 1030	390 à 520	385	Vrac gencodé	1
440993	3308184409938	9005 - 30%	990 à 1880	390 à 520	385	Vrac gencodé	1
440307	3308184403073	7016	300 à 550	390 à 520	385	Vrac gencodé	1
440557	3308184405572	7016	550 à 1030	390 à 520	385	Vrac gencodé	1
440997	3308184409976	7016	990 à 1880	390 à 520	385	Vrac gencodé	1

Tube acier

Code	Gencod		D	L	Type packaging	
440188	3308184401888		12	1030	Vrac gencodé	5

Vis indévissables + chevilles (x10)

Code	Gencod		D	L	Type packaging	
629850	3308186298509		8	60	Brochable gencodé	1

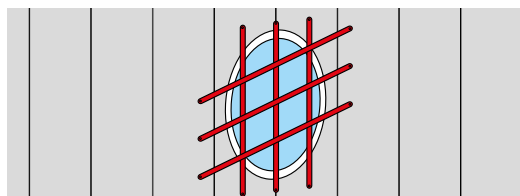
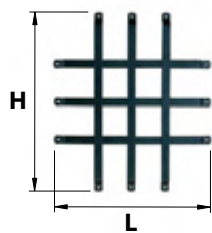

Grille de hublot

Code	Gencod		H	L	Type packaging	
1058806	3308187038067		426	376	Vrac gencodé	1

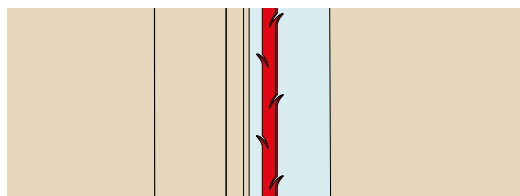
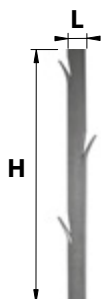

Barreau à épines

Code	Gencod		H	L	Ep.	Type packaging	
1110103	3308180044942	Z.BLANC	890	40	6	Vrac gencodé	1
1110203	3308180044959	Z.BLANC	1140	40	6	Vrac gencodé	1

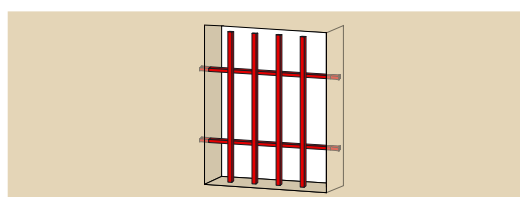
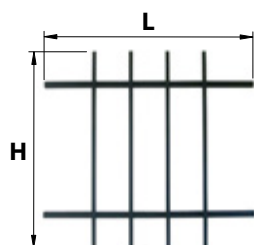

Grille éco à sceller barreaux creux

Code	Gencod		H	L	Type packaging	
0681000*	3308186810008		450	1200	Vrac gencodé	1
0681100*	3308186811005		750	600	Vrac gencodé	1
0681400*	3308186814006		950	600	Vrac gencodé	1

* Disponible sous 10 jours ouvrés.

Vous avez choisi votre produit et le modèle que vous souhaitez.
A présent, déterminez les dimensions à commander, puis sélectionnez la référence correspondante.

Pour trouver votre produit :

1 Mesurez votre ouverture

Grilles et grilles ouvrantes

Relevez :
1. la hauteur : H
2. et la largeur : L
de l'ouverture en l'exprimant en mm.
Ex : H = 600 x L = 400

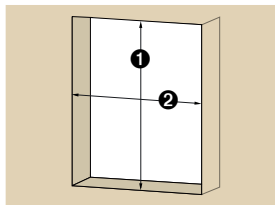

Œils-de-bœuf

Relevez le diamètre correspondant à l'ouverture, en l'exprimant en mm.

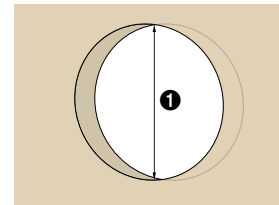

Barres d'appui et balconnets

Relevez la largeur entre les tableaux :
L : _____ mm

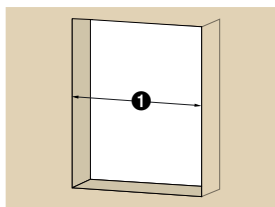

Important : la partie haute de la barre doit se situer à 1020 mm du sol.

Ne donnez que la longueur de la partie visible à votre relevé (voir visuel ci-dessous).

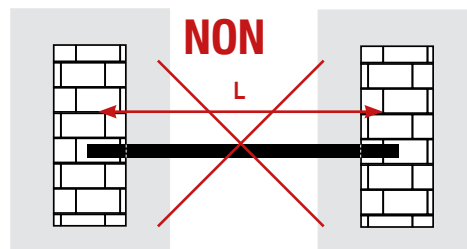
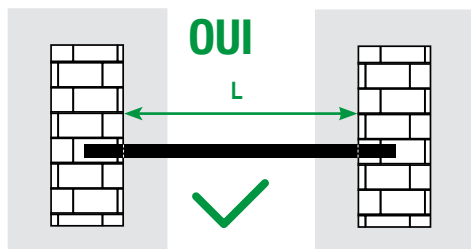

Nota : Vous devez reporter les dimensions exactes mesurées dans votre ouverture.
Nos services de fabrication se chargent de déterminer les dimensions réelles de la grille, qui seront différentes car nous prenons en compte le type de fixation.

2 Déterminez votre référence

Relevez vos dimensions dans les tableaux.

Grille Levant à sceller

Barreaux droits en fer plein carré de 14 mm
Traverses en fer plein carré de 14 mm

H x L	L 400 mm	LE01 mm	L 600 mm	L 800 mm	L 1000 mm	L 1200 mm	L 1400 mm
H 450 mm	053994 3308559000	056700 33085687000	059900 3308559007	059900 3308559904	059900 3308559007	059900 3308559000	059900 3308559009
H 600 mm	059900 3308559000	059700 3308559000	059900 3308559007	059900 3308559000	059900 3308559000	059900 3308559000	059900 3308559002
H 800 mm	059900 3308559000	059700 3308559000	059900 3308559000	059900 3308559007	059900 3308559000	059900 3308559000	059900 3308559000
H 1000 mm	059900 3308559000	059700 3308559000	059900 3308559000	059900 3308559000	059900 3308559000	059900 3308559000	059900 3308559000
H 1100 mm	059900 3308559000	059700 3308559000	059900 3308559000	059900 3308559000	059900 3308559000	059900 3308559000	059900 3308559000

Caractéristiques

- Peinture primaire antirouille noire
- Fabrication Française 
- Délai 4 semaines

Conseils de pose

- Peindre la grille une fois posée avec une peinture de finition antirouille.
- ATTENTION**
Pose façade : Les cotes correspondent aux dimensions du tableau.

Prise de cotes

Relevez :
 ① la hauteur : H
 ② la largeur : L
 correspondant à l'ouverture,
 en l'exprimant en mm.
 ex : H = 600 x L = 400

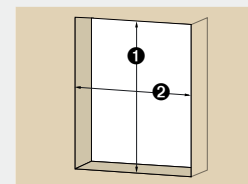

Grille Levant à sceller

Barreaux droits en fer plein carré de 14 mm
 Traverses en fer plein carré de 14 mm

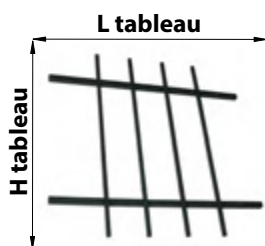

A sceller
 Pose tableau
 Peinture primaire noire antirouille

H / L	L400 mm	L500 mm	L600 mm	L800 mm	L1000 mm	L1200 mm	L1400 mm
H450 mm	0588900 3308185889005	0589700 3308185897000	0589800 3308185898007	0589900 3308185899004	0590000 3308185900007	0590300 3308185903008	0590600 3308185906009
H600 mm	0590800 3308185908003	0591200 3308185912000	0591300 3308185913007	0592400 3308185924003	0592500 3308185925000	0592600 3308185926007	0593400 3308185934002
H650 mm	0593500 3308185935009	0593700 3308185937003	0594100 3308185941000	0594200 3308185942007	0594400 3308185944001	0594500 3308185945008	0594600 3308185946005
H750 mm	0595300 3308185953003	0595500 3308185955007	0595900* 3308185959005	0596000 3308185960001	0596100 3308185961008	0596700 3308185967000	0597100 3308185971007
H950 mm	0597300 3308185973001	0597400 3308185974008	0597600* 3308185976002	0597800 3308185978006	0598000 3308185980009	0598100 3308185981006	0598200 3308185982003
H1050 mm	0598300 3308185983000	0598600 3308185986001	0598900 3308185989002	0599000 3308185990008	0599100 3308185991005	0599200 3308185992002	0599300 3308185993009
H1150 mm	0599400 3308185994006	0599500 3308185995003	0599600 3308185996000	0599700 3308185997007	0599800 3308185998004	0599900 3308185999001	0600200 3308186002007

* Disponible sous 10 jours ouvrés.

Grille Ponant à sceller

Barreaux droits en fer plein carré de 14 mm
 Traverses en fer plein carré de 14 mm avec trous renflés à chaud

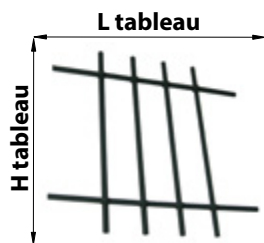

A sceller
 Pose tableau
 Peinture primaire noire antirouille

H / L	L400 mm	L500 mm	L600 mm	L800 mm	L1000 mm	L1200 mm	L1400 mm
H450 mm	0600300 3308186003004	0600400 3308186004001	0602700 3308186027000	0603900 3308186039003	0604000 3308186040009	0604500 3308186045004	0604600 3308186046001
H600 mm	0604700 3308186047008	0604900 3308186049002	0606900 3308186069000	0607000 3308186070006	0607100 3308186071003	0607200 3308186072000	0607400 3308186074004
H650 mm	0607500 3308186075001	0607700 3308186077005	0607800 3308186078002	0607900 3308186079009	0608000 3308186080005	0608100 3308186081002	0608200 3308186082009
H750 mm	0608400 3308186084003	0608500 3308186085000	0608700 3308186087004	0608800 3308186088001	0608900 3308186089008	0610000 3308186100000	0610300 3308186103001
H950 mm	0610400 3308186104008	0610500 3308186105005	0610600 3308186106002	0610700 3308186107009	0610800 3308186108006	0610900 3308186109003	0611300 3308186113000
H1050 mm	0611500 3308186115004	0612000 3308186120008	0612400 3308186124006	0612600 3308186126000	0612800 3308186128004	0613000 3308186130007	0613300 3308186133008
H1150 mm	0613400 3308186134005	0613500 3308186135002	0613600 3308186136009	0613700 3308186137006	0613900 3308186139000	0614000 3308186140006	0614100 3308186141003

Caractéristiques

- Peinture primaire antirouille noire
- Fabrication Française 
- Délai 4 semaines

Conseils de pose

- Peindre la grille une fois posée avec une peinture de finition antirouille.
- ATTENTION**
Pose façade : Les cotes correspondent aux dimensions du tableau.

Prise de cotes

Relevez :
 ① la hauteur : H
 ② la largeur : L
 correspondant à l'ouverture, en l'exprimant en mm.
 ex : H = 600 x L = 400

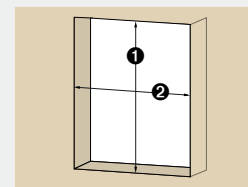

Grille Solano à sceller

Barreaux droits en fer plein carré de 14 mm
 Barreaux torsadés en fer plein carré de 14 mm

NOUVEAU

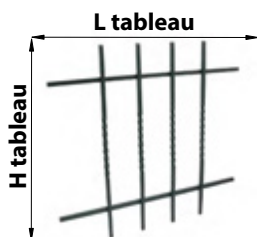

A sceller
 Pose tableau
 Peinture primaire noire antirouille

H / L	L400 mm	L500 mm	L600 mm	L800 mm	L1000 mm	L1200 mm	L1400 mm
H450 mm	0602000 3308186020001	0602001 3308186020018	0602002 3308186020025	0602003 3308186020032	0602004 3308186020049	0602005 3308186020056	0602006 3308186020063
H600 mm	0602007 3308186020070	0602008 3308186020087	0602009 3308186020094	0602010 3308186020100	0602011 3308186020117	0602012 3308186020124	0602013 3308186020131
H650 mm	0602014 3308186020148	0602015 3308186020155	0602016 3308186020162	0602017 3308186020179	0602018 3308186020186	0602019 3308186020193	0602020 3308186020209
H750 mm	0602021 3308186020216	0602022 3308186020223	0602023 3308186020230	0602024 3308186020247	0602025 3308186020254	0602026 3308186020261	0602027 3308186020278
H950 mm	0602028 3308186020285	0602029 3308186020292	0602030 3308186020308	0602031 3308186020315	0602032 3308186020322	0602033 3308186020339	0602034 3308186020346
H1050 mm	0602035 3308186020353	0602036 3308186020360	0602037 3308186020377	0602038 3308186020384	0602039 3308186020391	0602040 3308186020407	0602041 3308186020414
H1150 mm	0602042 3308186020421	0602043 3308186020438	0602044 3308186020445	0602045 3308186020452	0602046 3308186020469	0602047 3308186020476	0602048 3308186020483

Grille Mistral à sceller

Barreaux droits et ondulés en fer plein carré plein de 14 mm
 Traverses en fer plein carré de 14 mm

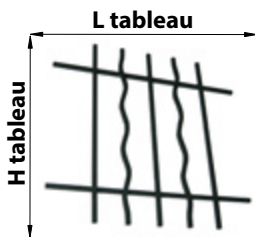

A sceller
 Pose tableau
 Peinture primaire noire antirouille

H / L	L400 mm	L500 mm	L600 mm	L800 mm	L1000 mm	L1200 mm	L1400 mm
H450 mm	0632700 3308186327001	0633800 3308186338007	0633900 3308186339004	0634000 3308186340000	0634100 3308186341007	0637300 3308186373008	0637400 3308186374005
H600 mm	0637500 3308186375002	0637600 3308186376009	0638100 3308186381003	0639800 3308186398001	0639900 3308186399008	0640000 3308186400001	0640300 3308186403002
H650 mm	0640400 3308186404009	0640500 3308186405006	0642100 3308186421006	0642800 3308186428005	0643200 3308186432002	0643300 3308186433009	0643500 3308186435003
H750 mm	0644000* 3308186440007	0644100 3308186441004	0644300* 3308186443008	0645400 3308186454004	0645500 3308186455001	0645600 3308186456008	0645700 3308186457005
H950 mm	0645800 3308186458002	0647300 3308186473005	0647400* 3308186474002	0648500* 3308186485008	0648700 3308186487002	0649200 3308186492006	0650600 3308186506000
H1050 mm	0650700 3308186507007	0651300 3308186513008	0651400 3308186514005	0651500 3308186515002	0651600 3308186516009	0651700 3308186517006	0652000 3308186520006
H1150 mm	0652200 3308186522000	0652500 3308186525001	0652600 3308186526008	0653200 3308186532009	0653400 3308186534003	0653500 3308186535000	0653600 3308186536007

* Disponible sous 10 jours ouvrés.

Caractéristiques

- Peinture primaire antirouille noire
- Fabrication Française 
- Délai 4 semaines

Conseils de pose

- Peindre la grille une fois posée avec une peinture de finition antirouille.
- ATTENTION**
Pose façade : Les cotes correspondent aux dimensions du tableau.

Prise de cotes

Relevez :
 ① la hauteur : H
 ② la largeur : L
 correspondant à l'ouverture,
 en l'exprimant en mm.
 ex : H = 600 x L = 400

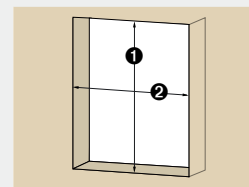

Grille Nordet à sceller

Barreaux droits en fer plein rond de 14 mm appointés à la forge
 Traverses en fer plein plat de 30x8 mm - Moulures décoratives

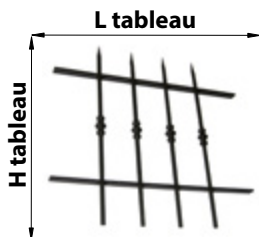

A sceller
 Pose tableau
 Peinture primaire noire antirouille

H / L	L400 mm	L500 mm	L600 mm	L800 mm	L1000 mm	L1200 mm	L1400 mm
H450 mm	0654000 3308186540004	0654100 3308186541001	0654300 3308186543005	0654600 3308186546006	0654700 3308186547003	0654900 3308186549007	0655100 3308186551000
H600 mm	0655300 3308186553004	0655600 3308186556005	0655700 3308186557002	0655900 3308186559006	0656100 3308186561009	0656300 3308186563003	0656700 3308186567001
H650 mm	0657000 3308186570001	0657100 3308186571008	0657600 3308186576003	0658200 3308186582004	0658400 3308186584008	0658800 3308186588006	0658900 3308186589003
H750 mm	0661400 3308186614002	0661900 3308186619007	0662000 3308186620003	0662500 3308186625008	0663300 3308186633003	0663500 3308186635007	0664000 3308186640001
H950 mm	0664100 3308186641008	0664200 3308186642005	0664300 3308186643002	0664400 3308186644009	0664500 3308186645006	0664600 3308186646003	0664700 3308186647000
H1050 mm	0664900 3308186649004	0665100 3308186651007	0665200 3308186652004	0665300 3308186653001	0665400 3308186654008	0665500 3308186655005	0665600 3308186656002
H1150 mm	0665700 3308186657009	0666000 3308186660009	0666400 3308186664007	0666500 3308186665004	0666600 3308186666001	0666700 3308186667008	0666800 3308186668005

Grille Galerne à sceller

Barreaux droits en fer plein carré de 14 mm
 Traverses en fer plein carré de 14 mm - Doubles volutes courbes

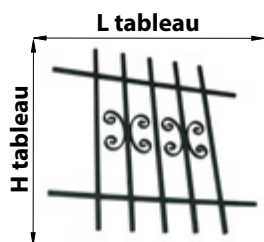

A sceller
 Pose tableau
 Peinture primaire noire antirouille

H / L	L400 mm	L500 mm	L600 mm	L800 mm	L1000 mm	L1200 mm	L1400 mm
H450 mm	0614200 3308186142000	0614500 3308186145001	0614700 3308186147005	0615000 3308186150005	0615100 3308186151002	0615200 3308186152009	0615300 3308186153006
H600 mm	0615400 3308186154003	0615500 3308186155000	0615600 3308186156007	0615700 3308186157004	0615800 3308186158001	0615900 3308186159008	0616000 3308186160004
H650 mm	0616100 3308186161001	0616200 3308186162008	0616900 3308186169007	0617000 3308186170003	0617100 3308186171000	0617300 3308186173004	0617400 3308186174001
H750 mm	0617600 3308186176005	0617700 3308186177002	0618700 3308186187001	0619600 3308186196003	0619700 3308186197000	0619900 3308186199004	0620000 3308186200007
H950 mm	0620100 3308186201004	0620300 3308186203008	0620700 3308186207006	0620900 3308186209000	0621600 3308186216008	0621900 3308186219009	0622500 3308186225000
H1050 mm	0623000 3308186230004	0623100 3308186231001	0623200 3308186232008	0623600 3308186236006	0624100 3308186241000	0624400 3308186244001	0624500 3308186245008
H1150 mm	0625500 3308186255007	0625700 3308186257001	0626700 3308186267000	0626800 3308186268007	0627400 3308186274008	0628100 3308186281006	0628700 3308186287008

Caractéristiques

- Peinture primaire antirouille noire
- Fabrication Française 
- Délai 4 semaines

Conseils de pose

- Peindre la grille une fois posée avec une peinture de finition antirouille.
- ATTENTION**
Pose façade : Les cotes correspondent aux dimensions du tableau.

Prise de cotes

Relevez :
 ① la hauteur : H
 ② la largeur : L
 correspondant à l'ouverture, en l'exprimant en mm.
 ex : H = 600 x L = 400

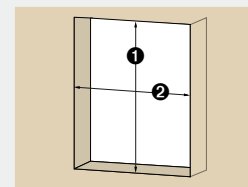

NOUVEAU

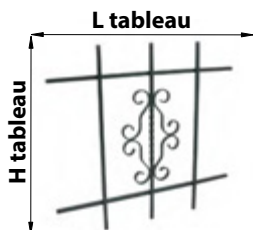

A sceller
 Pose tableau
 Peinture primaire noire antirouille

Grille Marine à sceller

Barreaux droits en fer plein carré de 14 mm

Traverses en fer plein carré de 14 mm

Barreaux, avec volutes, torsadés au milieu sur 200 mm - Volutes en fer plat de 14 x 6 mm

H / L	L400 mm	L500 mm	L600 mm	L800 mm	L1000 mm	L1200 mm	L1400 mm
H450 mm	0602100 3308186021008	0602101 3308186021015	0602102 3308186021022	0602103 3308186021039	0602104 3308186021046	0602105 3308186021053	0602106 3308186021060
H600 mm	0602107 3308186021077	0602108 3308186021084	0602109 3308186021091	0602110 3308186021107	0602111 3308186021114	0602112 3308186021121	0602113 3308186021138
H650 mm	0602114 3308186021145	0602115 3308186021152	0602116 3308186021169	0602117 3308186021176	0602118 3308186021183	0602119 3308186021190	0602120 3308186021206
H750 mm	0602121 3308186021213	0602122 3308186021220	0602123 3308186021237	0602124 3308186021244	0602125 3308186021251	0602126 3308186021268	0602127 3308186021275
H950 mm	0602128 3308186021282	0602129 3308186021299	0602130 3308186021305	0602131 3308186021312	0602132 3308186021329	0602133 3308186021336	0602134 3308186021343
H1050 mm	0602135 3308186021350	0602136 3308186021367	0602137 3308186021374	0602138 3308186021381	0602139 3308186021398	0602140 3308186021404	0602141 3308186021411
H1150 mm	0602142 3308186021428	0602143 3308186021435	0602144 3308186021442	0602145 3308186021459	0602146 3308186021466	0602147 3308186021473	0602148 3308186021480

Grille Autan à sceller

Barreaux en fer plat de 40x5 mm à épines et extrémités en queue de carpe

Traverses en fer plein carré de 14 mm

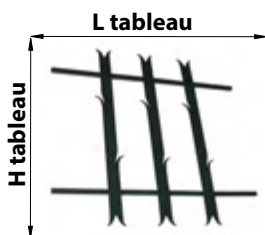

A sceller
 Pose tableau
 Peinture primaire noire antirouille

H / L	L400 mm	L500 mm	L600 mm	L800 mm	L1000 mm	L1200 mm	L1400 mm
H450 mm	0666900 3308186669002	0667100 3308186671005	0667200 3308186672002	0667300 3308186673009	0667400 3308186674006	0667600 3308186676000	0668100 3308186681004
H600 mm	0670000 3308186700002	0670300 3308186703003	0670400 3308186704000	0670500 3308186705007	0670600 3308186706004	0670700 3308186707001	0670900 3308186709005
H650 mm	0671100 3308186711008	0671200 3308186712005	0671300 3308186713002	0671700 3308186717000	0672300 3308186723001	0672500 3308186725005	0672600 3308186726002
H750 mm	0672700 3308186727009	0672900 3308186729003	0673100 3308186731006	0673300 3308186733000	0673500 3308186735004	0673700 3308186737008	0673900 3308186739002
H950 mm	0674100 3308186741005	0674200 3308186742002	0674500 3308186745003	0674800 3308186748004	0674900 3308186749001	0675000 3308186750007	0675100 3308186751004
H1050 mm	0675200 3308186752001	0675300 3308186753008	0675400 3308186754005	0675600 3308186756009	0675700 3308186757006	0676300 3308186763007	0676400 3308186764004
H1150 mm	0676800 3308186768002	0676900 3308186769009	0677100 3308186771002	0677200 3308186772009	0677400 3308186774003	0677600 3308186776007	0677700 3308186777004

Caractéristiques

- Peinture primaire antirouille noire
- Fabrication Française 
- Délai 4 semaines

Conseils de pose

- Peindre la grille une fois posée avec une peinture de finition antirouille.
- ATTENTION**
Pose façade : Les cotes correspondent aux dimensions du tableau.

Prise de cotes

Relevez :
 ① la hauteur : H
 ② la largeur : L
 correspondant à l'ouverture, en l'exprimant en mm.
 ex : H = 600 x L = 400

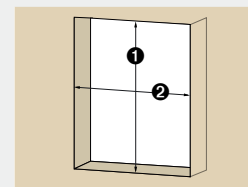

Grille Tramontane à sceller

Barreaux en fer plat torsadé de 20x5 mm
 Traverses en fer plein carré de 14 mm

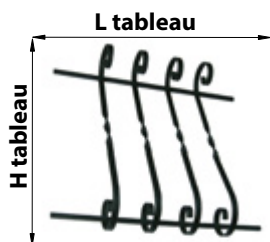

A sceller
 Pose tableau
 Peinture primaire noire antirouille

H / L	L400 mm	L500 mm	L600 mm	L800 mm	L1000 mm	L1200 mm	L1400 mm
H450 mm	0517100 3308185171001	0517200 3308185172008	0517700 3308185177003	0517800 3308185178000	0518800 3308185188009	0518900 3308185189006	0520300 3308185203009
H600 mm	0520400 3308185204006	0520900 3308185209001	0521900 3308185219000	0522000 3308185220006	0522300 3308185223007	0522400 3308185224004	0522500 3308185225001
H650 mm	0522700 3308185227005	0522900 3308185229009	0523000 3308185230005	0523500 3308185235000	0523600 3308185236007	0525200 3308185252007	0526400 3308185264000
H750 mm	0526500 3308185265007	0526600 3308185266004	0526700 3308185267001	0526800 3308185268008	0526900 3308185269005	0527300 3308185273002	0527400 3308185274009
H950 mm	0527600 3308185276003	0527800 3308185278007	0527900 3308185279004	0528000 3308185280000	0528100 3308185281007	0528200 3308185282004	0528300 3308185283001
H1050 mm	0528400 3308185284008	0528500 3308185285005	0528800 3308185288006	0529000 3308185290009	0529100 3308185291006	0529500 3308185295004	0529600 3308185296001
H1150 mm	0529700 3308185297008	0529800 3308185298005	0529900 3308185299002	0530200 3308185302009	0530900 3308185309008	0531000 3308185310004	0531100 3308185311001

Grille Lombarde à sceller

Barreaux cambrés en fer plein carré de 14 mm
 Traverses en plein carré de 14 mm

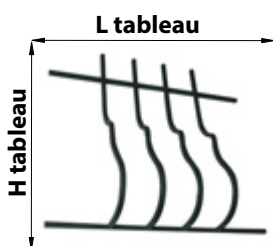

A sceller
 Pose tableau
 Peinture primaire noire antirouille

H / L	L400 mm	L500 mm	L600 mm	L800 mm	L1000 mm	L1200 mm	L1400 mm
H600 mm	0531200 3308185312008	0531300 3308185313005	0531400 3308185314002	0531500 3308185315009	0531700 3308185317003	0532500 3308185325008	0532600 3308185326005
H650 mm	0532700 3308185327002	0532800 3308185328009	0532900 3308185329006	0533000 3308185330002	0533100 3308185331009	0533600 3308185336004	0534800 3308185348007
H750 mm	0534900 3308185349004	0535000 3308185350000	0535900 3308185359003	0536100 3308185361006	0536300 3308185363000	0536600 3308185366001	0536700 3308185367008
H950 mm	0537000 3308185370008	0537100 3308185371005	0537200 3308185372002	0537300 3308185373009	0537400 3308185374006	0537500 3308185375003	0537600 3308185376000
H1050 mm	0538000 3308185380007	0538200 3308185382001	0539100 3308185391003	0540600 3308185406004	0540900 3308185409005	0541100 3308185411008	0542100 3308185421007
H1150 mm	0542200 3308185422004	0542300 3308185423001	0542400 3308185424008	0542900 3308185429003	0543300 3308185433000	0543400 3308185434007	0543500 3308185435004

Caractéristiques

- Peinture primaire antirouille noire
- Fabrication Française 
- Délai 4 semaines

Conseils de pose

- Peindre la grille une fois posée avec une peinture de finition antirouille.
- ATTENTION**
Pose façade : Les cotes correspondent aux dimensions du tableau.

Prise de cotes

Relevez :
 ① la hauteur : H
 ② la largeur : L
 correspondant à l'ouverture, en l'exprimant en mm.
 ex : H = 600 x L = 400

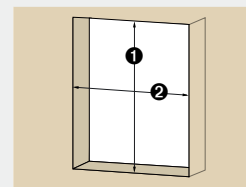

Grille Lombarde à sceller en façade

Barreaux cambrés en fer plein carré de 14 mm

Traverses en plein carré de 14 mm

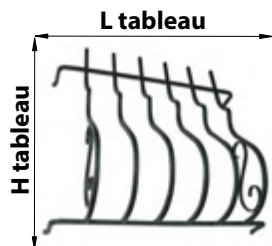

A sceller
 Pose tableau
 Peinture primaire noire antirouille

H / L	L400 mm	L500 mm	L600 mm	L800 mm	L1000 mm	L1200 mm	L1400 mm
H450 mm	0543700 3308185437008	0543900 3308185439002	0544000 3308185440008	0544100 3308185441005	0544500 3308185445003	0544600 3308185446000	0544700 3308185447007
H600 mm	0544800 3308185448004	0544900 3308185449001	0545000 3308185450007	0545100 3308185451004	0545200 3308185452001	0545300 3308185453008	0545400 3308185454005
H650 mm	0545500 3308185455002	0545600 3308185456009	0545700 3308185457006	0545800 3308185458003	0545900 3308185459000	0546000 3308185460006	0546100 3308185461003
H750 mm	0546400 3308185464004	0546500 3308185465001	0546600 3308185466008	0547200 3308185472009	0547300 3308185473006	0547400 3308185474003	0547600 3308185476007
H950 mm	0547900 3308185479008	0548000 3308185480004	0548600 3308185486006	0548700 3308185487003	0550000 3308185500009	0551000 3308185510008	0551200 3308185512002
H1050 mm	0551300 3308185513009	0551600 3308185516000	0551700 3308185517007	0551800 3308185518004	0551900 3308185519001	0552200 3308185522001	0552300 3308185523008
H1150 mm	0552400 3308185524005	0552500 3308185525002	0552800 3308185528003	0553600 3308185536008	0553800 3308185538002	0553900 3308185539009	0554300 3308185543006

Caractéristiques

- Peinture primaire antirouille noire
- Fabrication Française 
- Délai 4 semaines

Conseils de pose

- Peindre la grille une fois posée avec une peinture de finition antirouille.
- ATTENTION**
Pose façade : Les cotes correspondent aux dimensions du tableau.

Prise de cotes

Relevez :
 ① la hauteur : H
 ② la largeur : L
 correspondant à l'ouverture, en l'exprimant en mm.
 ex : H = 600 x L = 400

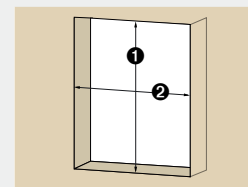

Grille Aquilon à sceller

Barreaux en fer plein carré de 14 mm
 Traverses en fer plein carré de 14 mm

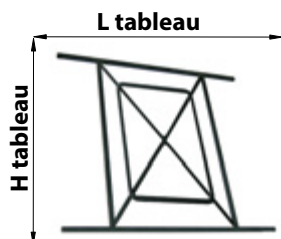

A sceller
 Pose tableau
 Peinture primaire noire antirouille

H / L	L400 mm	L500 mm	L600 mm	L800 mm	L1000 mm	L1200 mm	L1400 mm
H450 mm	0560200 (A) 3308185602000	0560300 (A) 3308185603007	0560600 (A) 3308185606008	0560700 (A) 3308185607005	0560800 (C) 3308185608002	0560900 (C) 3308185609009	0561000 (C) 3308185610005
H600 mm	0561100 (A) 3308185611002	0561200 (A) 3308185612009	0561500 (A) 3308185615000	0561600 (A) 3308185616007	0562400 (C) 3308185624002	0562500 (C) 3308185625009	0562700 (C) 3308185627003
H650 mm	0562900 (A) 3308185629007	0563100 (A) 3308185631000	0563300 (A) 3308185633004	0563500 (A) 3308185635008	0563700 (C) 3308185637002	0563900 (C) 3308185639006	0564100 (C) 3308185641009
H750 mm	0564300 (A) 3308185643003	0564500 (A) 3308185645007	0564700 (A) 3308185647001	0567700 (A) 3308185677008	0567800 (C) 3308185678005	0568400 (C) 3308185684006	0568500 (C) 3308185685003
H950 mm	0568800 (A) 3308185688004	0569100 (A) 3308185691004	0569900 (A) 3308185699000	0570100 (A) 3308185701000	0570300 (C) 3308185703004	0570700 (C) 3308185707002	0571100 (C) 3308185711009
H1050 mm	0571700 (B) 3308185717001	0571900 (B) 3308185719005	0572100 (B) 3308185721008	0572200 (B) 3308185722005	0573100 (D) 3308185731007	0573500 (D) 3308185735005	0573600 (D) 3308185736002
H1150 mm	0573700 (B) 3308185737009	0574100 (B) 3308185741006	0575500 (B) 3308185755003	0575600 (B) 3308185756000	0575700 (D) 3308185757007	0575800 (D) 3308185758004	0575900 (D) 3308185759001



A



B



C



D

Grille Zephyr à sceller

Barreaux en fer plein carré de 14 mm
 Traverses en fer plein carré de 14 mm - Rosace décorative

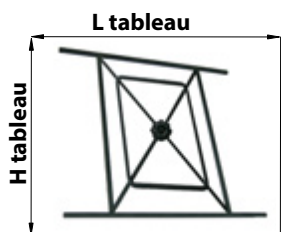

A sceller
 Pose tableau
 Peinture primaire noire antirouille

H / L	L400 mm	L500 mm	L600 mm	L800 mm	L1000 mm	L1200 mm	L1400 mm
H450 mm	0576000 (A) 3308185760007	0576100 (A) 3308185761004	0576200 (A) 3308185762001	0576300 (A) 3308185763008	0576600 (C) 3308185766009	0577600 (C) 3308185776008	0577700 (C) 3308185777005
H600 mm	0577800 (A) 3308185778002	0577900 (A) 3308185779009	0578000 (A) 3308185780005	0578300 (A) 3308185783006	0578700 (C) 3308185787004	0578800 (C) 3308185788001	0578900 (C) 3308185789008
H650 mm	0579000 (A) 3308185790004	0579100 (A) 3308185791001	0579200 (A) 3308185792008	0579300 (A) 3308185793005	0579400 (C) 3308185794002	0579500 (C) 3308185795009	0579600 (C) 3308185796006
H750 mm	0579700 (A) 3308185797003	0579800 (A) 3308185798000	0579900 (A) 3308185799007	0580000 (A) 3308185800000	0580100 (C) 3308185801007	0580200 (C) 3308185802004	0580400 (C) 3308185804008
H950 mm	0580500 (A) 3308185805005	0580600 (A) 3308185806002	0580700 (A) 3308185807009	0580900 (A) 3308185809003	0581300 (C) 3308185813000	0581400 (C) 3308185814007	0583900 (C) 3308185839000
H1050 mm	0584100 (B) 3308185841003	0584400 (B) 3308185844004	0584800 (B) 3308185848002	0584900 (B) 3308185849009	0585000 (D) 3308185850005	0585400 (D) 3308185854003	0585700 (D) 3308185857004
H1150 mm	0585800 (B) 3308185858001	0586000 (B) 3308185860004	0586200 (B) 3308185862008	0586400 (B) 3308185864002	0586600 (D) 3308185866006	0586900 (D) 3308185869007	0587000 (D) 3308185870003

Caractéristiques

- Peinture primaire antirouille noire
- Fabrication Française 
- Délai 4 semaines

Conseils de pose

- Peindre la grille une fois posée avec une peinture de finition antirouille.
- ATTENTION**
Pose façade : Les cotes correspondent aux dimensions du tableau.

Prise de cotes

Relevez :
 ① la hauteur : H
 ② la largeur : L
 correspondant à l'ouverture,
 en l'exprimant en mm.
 ex : H = 600 x L = 400

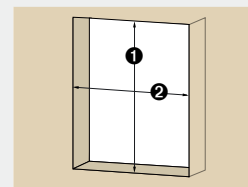

Grille Libeccio à sceller

Barreaux en fer plein carré de 14 mm
 Traverses en fer plein carré de 14 mm

NOUVEAU

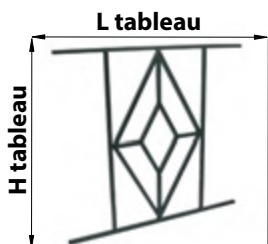

A sceller
 Pose tableau
 Peinture primaire noire antirouille

H / L	L400 mm	L500 mm	L600 mm	L800 mm	L1000 mm	L1200 mm	L1400 mm
H450 mm	0601900 (A) 3308186019005	0601901 (A) 3308186019012	0601902 (A) 3308186019029	0601903 (A) 3308186019036	0601904 (C) 3308186019043	0601905 (C) 3308186019050	0601906 (C) 3308186019067
H600 mm	0601907 (A) 3308186019074	0601908 (A) 3308186019081	0601909 (A) 3308186019098	0601910 (A) 3308186019104	0601911 (C) 3308186019111	0601912 (C) 3308186019128	0601913 (C) 3308186019135
H650 mm	0601914 (A) 3308186019142	0601915 (A) 3308186019159	0601916 (A) 3308186019166	0601917 (A) 3308186019173	0601918 (C) 3308186019180	0601919 (C) 3308186019197	0601920 (C) 3308186019203
H750 mm	0601921 (A) 3308186019210	0601922 (A) 3308186019227	0601923 (A) 3308186019234	0601924 (A) 3308186019241	0601925 (C) 3308186019258	0601926 (C) 3308186019265	0601927 (C) 3308186019272
H950 mm	0601928 (A) 3308186019289	0601929 (A) 3308186019296	0601930 (A) 3308186019302	0601931 (A) 3308186019319	0601932 (C) 3308186019326	0601933 (C) 3308186019333	0601934 (C) 3308186019340
H1050 mm	0601935 (B) 3308186019357	0601936 (B) 3308186019364	0601937 (B) 3308186019371	0601938 (B) 3308186019388	0601939 (D) 3308186019395	0601940 (D) 3308186019401	0601941 (D) 3308186019418
H1150 mm	0601942 (B) 3308186019425	0601943 (B) 3308186019432	0601944 (B) 3308186019449	0601945 (B) 3308186019456	0601946 (D) 3308186019463	0601947 (D) 3308186019470	0601948 (D) 3308186019487

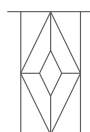

A

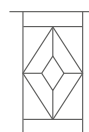

B

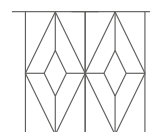

C

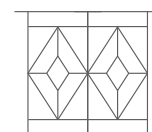

D

Grille Vendée à sceller

Barreaux en fer plein plat de 30 x 8 mm
 Traverses en fer plein plat de 30 x 8 mm

NOUVEAU

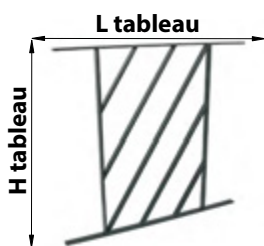

A sceller
 Pose tableau
 Peinture primaire noire antirouille

H / L	L400 mm	L500 mm	L600 mm	L800 mm	L1000 mm	L1200 mm	L1400 mm
H450 mm	0602050 3308186020506	0602051 3308186020513	0602052 3308186020520	0602053 3308186020537	0602054 3308186020544	0602055 3308186020551	0602056 3308186020568
H600 mm	0602057 3308186020575	0602058 3308186020582	0602059 3308186020599	0602060 3308186020605	0602061 3308186020612	0602062 3308186020629	0602063 3308186020636
H650 mm	0602064 3308186020643	0602065 3308186020650	0602066 3308186020667	0602067 3308186020674	0602068 3308186020681	0602069 3308186020698	0602070 3308186020704
H750 mm	0602071 3308186020711	0602072 3308186020728	0602073 3308186020735	0602074 3308186020742	0602075 3308186020759	0602076 3308186020766	0602077 3308186020773
H950 mm	0602078 3308186020780	0602079 3308186020797	0602080 3308186020803	0602081 3308186020810	0602082 3308186020827	0602083 3308186020834	0602084 3308186020841
H1050 mm	0602085 3308186020858	0602086 3308186020865	0602087 3308186020872	0602088 3308186020889	0602089 3308186020896	0602090 3308186020902	0602091 3308186020919
H1150 mm	0602092 3308186020926	0602093 3308186020933	0602094 3308186020940	0602095 3308186020957	0602096 3308186020964	0602097 3308186020971	0602098 3308186020988

Caractéristiques

- Peinture primaire antirouille noire
- Fabrication Française 
- Délai 4 semaines

Conseils de pose

- Peindre la grille une fois posée avec une peinture de finition antirouille.
- ATTENTION**
Pose façade : Les cotes correspondent aux dimensions du tableau.

Prise de cotes

Relevez :
 ❶ la hauteur : H
 ❷ la largeur : L
 correspondant à l'ouverture, en l'exprimant en mm.
 ex : H = 600 x L = 400

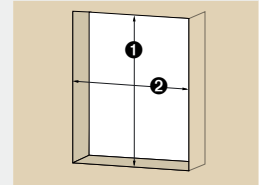

NOUVEAU

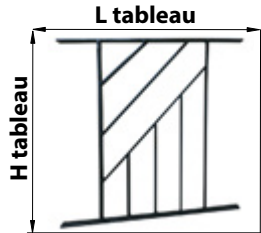

A sceller
 Pose tableau
 Peinture primaire noire antirouille

Grille Bora à sceller

Barreaux en fer plein plat de 30 x 8 mm
 Traverses en fer plein plat de 30 x 8 mm

H / L	L400 mm	L500 mm	L600 mm	L800 mm	L1000 mm
H450 mm	0601850 (A) 3308186018503	0601851 (A) 3308186018510	0601852 (A) 3308186018527	-	-
H600 mm	0601857 (A) 3308186018572	0601858 (A) 3308186018589	0601859 (A) 3308186018596	-	-
H650 mm	0601864 (A) 3308186018640	0601865 (A) 3308186018657	0601866 (A) 3308186018664	-	-
H750 mm	0601871 (A) 3308186018718	0601872 (A) 3308186018725	0601873 (A) 3308186018732	-	-
H950 mm	0601878 (A) 3308186018787	0601879 (A) 3308186018794	0601880 (A) 3308186018800	0601881 (A) 3308186018817	0601882 (A) 3308186018824
H1050 mm	0601885 (B) 3308186018855	0601886 (B) 3308186018862	0601887 (B) 3308186018879	0601888 (A) 3308186018886	0601889 (A) 3308186018893
H1150 mm	0601892 (B) 3308186018923	0601893 (B) 3308186018930	0601894 (B) 3308186018947	0601895 (A) 3308186018954	0601896 (A) 3308186018961

Autres dimensions sur demande.

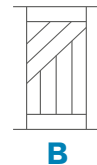

NOUVEAU

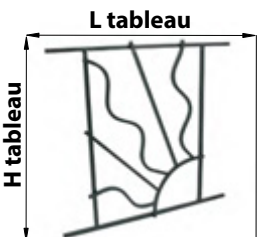

A sceller
 Pose tableau
 Peinture primaire noire antirouille

Grille Astrale à sceller

Barreaux en fer plein carré de 14 mm
 Traverses en fer plein carré de 14 mm

H / L	L400 mm	L500 mm	L600 mm	L800 mm	L1000 mm	L1200 mm	L1400 mm
H450 mm	0601800 (A) 3308186018008	0601801 (A) 3308186018015	0601802 (A) 3308186018022	0601803 (A) 3308186018039	0601804 (A) 3308186018046	0601805 (B) 3308186018053	0601806 (B) 3308186018060
H600 mm	0601807 (A) 3308186018077	0601808 (A) 3308186018084	0601809 (A) 3308186018091	0601810 (A) 3308186018107	0601811 (A) 3308186018114	0601812 (B) 3308186018121	0601813 (B) 3308186018138
H650 mm	0601814 (A) 3308186018145	0601815 (A) 3308186018152	0601816 (A) 3308186018169	0601817 (A) 3308186018176	0601818 (A) 3308186018183	0601819 (B) 3308186018190	0601820 (B) 3308186018206
H750 mm	0601821 (A) 3308186018213	0601822 (A) 3308186018220	0601823 (A) 3308186018237	0601824 (A) 3308186018244	0601825 (A) 3308186018251	0601826 (B) 3308186018268	0601827 (B) 3308186018275
H950 mm	0601828 (A) 3308186018282	0601829 (A) 3308186018299	0601830 (A) 3308186018305	0601831 (A) 3308186018312	0601832 (A) 3308186018329	0601833 (B) 3308186018336	0601834 (B) 3308186018343
H1050 mm	0601835 (A) 3308186018350	0601836 (A) 3308186018367	0601837 (A) 3308186018374	0601838 (A) 3308186018381	0601839 (A) 3308186018398	0601840 (B) 3308186018404	0601841 (B) 3308186018411
H1150 mm	0601842 (A) 3308186018428	0601843 (A) 3308186018435	0601844 (A) 3308186018442	0601845 (A) 3308186018459	0601846 (A) 3308186018466	0601847 (B) 3308186018473	0601848 (B) 3308186018480

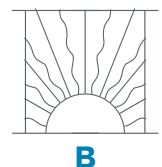
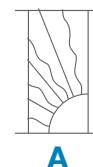

Caractéristiques

- Peinture primaire antirouille noire
- Fabrication Française 
- Délai 4 semaines

Conseils de pose

• Peindre la grille une fois posée avec une peinture de finition antirouille.
ATTENTION
 Pose façade : Les cotes correspondent aux dimensions du tableau.



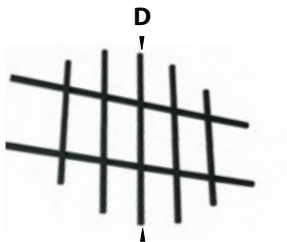
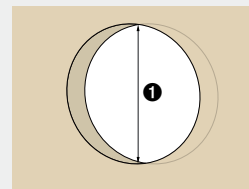

Prise de cotes

Relevez :
 ① le diamètre D correspondant à l'ouverture, en l'exprimant en mm.
 ex : D = 600



Oeil-de-bœuf Levant à sceller



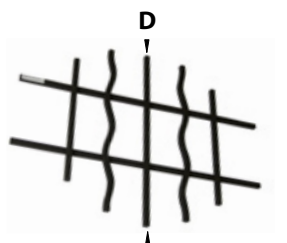

Barreaux droits en fer plein carré de 14 mm
 Traverses en fer plein carré de 14 mm

Code	Gencod		D	Type packaging	
0500700	3308185007003		600	Vrac gencodé	1
0503800	3308185038007		700	Vrac gencodé	1
0504900	3308185049003		800	Vrac gencodé	1



Oeil-de-bœuf Mistral à sceller



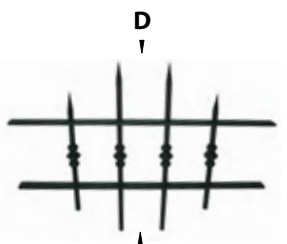

Barreaux droits et ondulés en fer plein carré de 14 mm
 Traverses en fer plein carré de 14 mm

Code	Gencod		D	Type packaging	
0505000	3308185050009		600	Vrac gencodé	1
0505100	3308185051006		700	Vrac gencodé	1
0505200	3308185052003		800	Vrac gencodé	1



Oeil-de-bœuf Nordet à sceller



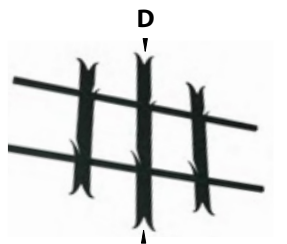

Barreaux droits en fer plein rond de 14 mm appointés à la forge
 Traverses en fer plein plat de 30x8 mm - Moulures décoratives

Code	Gencod		D	Type packaging	
0505300	3308185053000		600	Vrac gencodé	1
0505400	3308185054007		700	Vrac gencodé	1
0507400	3308185074005		800	Vrac gencodé	1



Oeil-de-bœuf Autan à sceller



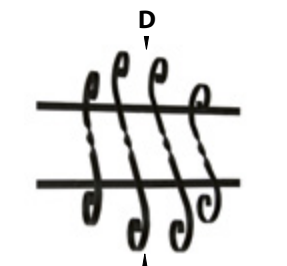

Barreaux en fer plein plat de 40x5 mm à épines et extrémités en queue de carpe
 Traverses en fer plein carré de 14 mm

Code	Gencod		D	Type packaging	
0507500	3308185075002		600	Vrac gencodé	1
0507600	3308185076009		700	Vrac gencodé	1
0507700	3308185077006		800	Vrac gencodé	1



Oeil-de-bœuf Tramontane à sceller

Barreaux en fer plat torsadé de 20x15 mm
 Traverses en fer plein carré de 14 mm

Code	Gencod		D	Type packaging	
0507900	3308185079000		600	Vrac gencodé	1
0508000	3308185080006		700	Vrac gencodé	1
0508600	3308185086008		800	Vrac gencodé	1

Caractéristiques

- Peinture primaire antirouille noire
- Fabrication Française 
- Délai 4 semaines

Conseils de pose

- Peindre la grille une fois posée avec une peinture de finition antirouille.

Prise de cotes

Relevez :
 ● la largeur : L
 L : _ , _ , _ mm

IMPORTANT : la partie haute du balconnet doit se situer à 1020 mm du sol.

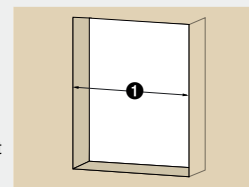

A sceller
 Pose tableau uniquement
 Peinture primaire noire antirouille

Barre d'appui Levant /ml

Main courante moulurée de 40 mm
 Barreau en fer plein carré de 14 mm

Code	Gencod	Type packaging	
0508700	3308185087005	Vrac gencodé	1

Largeur maximum : 1700 mm



A sceller
 Pose tableau uniquement
 Peinture primaire noire antirouille

Barre d'appui Galerne /ml

Main courante moulurée de 40 mm
 Barreau en fer plein carré de 14 mm - Volutes et rond en fer plat

Code	Gencod	Type packaging	
0509100	3308185091002	Vrac gencodé	1

Largeur maximum : 1700 mm



A sceller
 Pose tableau uniquement
 Peinture primaire noire antirouille

Barre d'appui Tramontane /ml

Main courante moulurée de 40 mm
 Barreau en fer plein carré de 14 mm - Volutes et rond en fer plat

Code	Gencod	Type packaging	
0509900	3308185099008	Vrac gencodé	1

Largeur maximum : 1700 mm

Caractéristiques

- Peinture primaire antirouille noire
- Fabrication Française 
- Délai 4 semaines

Conseils de pose

- Peindre la grille une fois posée avec une peinture de finition antirouille.

Prise de cotes

Relevez :

❶ la largeur : L





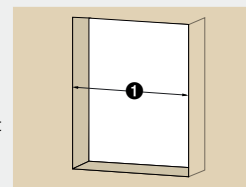

L : _____ m (max: 1500 mm)

IMPORTANT : la partie haute du balconnet doit se situer à 1020 mm du sol.

Choisir la hauteur en conséquence



Balconnet Levant à sceller







Code	Gencod		H	Type packaging	
0510500	3308185105006		400	Vrac gencodé	1
0510600	3308185106003		600	Vrac gencodé	1
0511100	3308185111007		800	Vrac gencodé	1
0511300	3308185113001		1000	Vrac gencodé	1

Largeur maximum : 1500 mm

Main courante moulurée de 40 mm
Barreaux droits en fer plein carré de 14 mm
Traverses en fer plein carré de 14 mm



Balconnet Mistral à sceller







Code	Gencod		H	Type packaging	
0511500	3308185115005		400	Vrac gencodé	1
0511600	3308185116002		600	Vrac gencodé	1
0511800	3308185118006		800	Vrac gencodé	1
0512200	3308185122003		1000	Vrac gencodé	1

Largeur maximum : 1500 mm

Main courante moulurée de 40 mm
Barreaux droits et ondulés en fer plein carré de 14 mm
Traverses en fer plein carré de 14 mm



Balconnet Nordet à sceller

Code	Gencod		H	Type packaging	
0512500	3308185125004		400	Vrac gencodé	1
0512800	3308185128005		600	Vrac gencodé	1
0512900	3308185129002		800	Vrac gencodé	1
0513200	3308185132002		1000	Vrac gencodé	1

Largeur maximum : 1500 mm

Main courante moulurée de 40 mm
Barreaux droits en fer plein rond de 14 mm appointés à la forge
Traverses en fer plein plat de 30x8 mm - Moulures décoratives

Caractéristiques

- Peinture primaire antirouille noire
- Fabrication Française 
- Délai 4 semaines

Conseils de pose

- Peindre la grille une fois posée avec une peinture de finition antirouille.

Prise de cotes

Relevez :

❶ la largeur : L





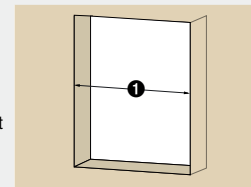

L : m (max: 1500 mm)

IMPORTANT : la partie haute du balconnet doit se situer à 1020 mm du sol.

Choisir la hauteur en conséquence



Balconnet Galerie à sceller

Code	Gencod		H	Type packaging	
0513300	3308185133009		400	Vrac gencodé	1
0513400	3308185134006		600	Vrac gencodé	1
0513500	3308185135003		800	Vrac gencodé	1
0513600	3308185136000		1000	Vrac gencodé	1

Largeur maximum : 1500 mm





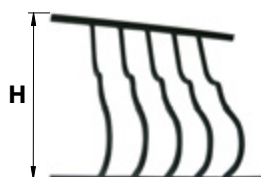

Main courante moulurée de 40 mm

Barreaux droits en fer plein carré de 14 mm

Traverses en fer plein carré de 14 mm - Doubles volutes courbes



Balconnet Lombarde à sceller

Code	Gencod		H	Type packaging	
0514500	3308185145002		400	Vrac gencodé	1
0514600	3308185146009		600	Vrac gencodé	1
0514900	3308185149000		800	Vrac gencodé	1
0516900	3308185169008		1000	Vrac gencodé	1

Largeur maximum : 1500 mm

Main courante moulurée de 40 mm

Barreaux cambrés en fer plein carré de 14 mm

Traverses en fer plein carré de 14 mm

Caractéristiques

- Peinture primaire antirouille noire
- Fabrication Française 
- Délai 4 semaines

Conseils de pose

- Peindre la grille une fois posée avec une peinture de finition antirouille.

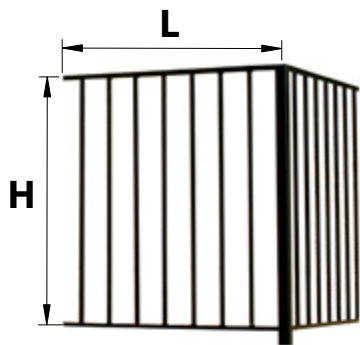

Garde-corps Levant

Code	Gencod		H	L	Type packaging	
0681600	3308186816000		970	1460	Vrac gencodé	1

Barreaux droits en fer plein carré de 14 mm

Main courante moulurée de 40 mm

Traverses en fer plein carré de 14 mm

Pas besoin de soudure.

Le garde-corps se glisse dans les poteaux balcon
ou les platines à visser.

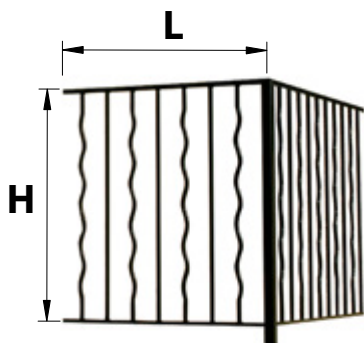

Garde-corps Mistral

Code	Gencod		H	L	Type packaging	
0681700	3308186817007		970	1460	Vrac gencodé	1

Barreaux droits et ondulés en fer plein carré de 14 mm

Main courante moulurée de 40 mm

Traverses en fer plein carré de 14 mm

Pas besoin de soudure.

Le garde-corps se glisse dans les poteaux balcon
ou les platines à visser.

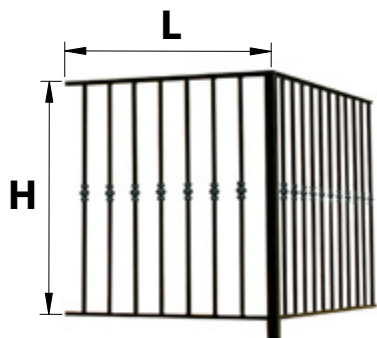

Garde-corps Nordet

Code	Gencod		H	L	Type packaging	
0681800	3308186818004		970	1460	Vrac gencodé	1

Barreaux droits en fer plein rond de 14 mm appointés à la forge

Main courante moulurée de 40 mm

Traverses en fer plein carré de 14 mm

Pas besoin de soudure.

Le garde-corps se glisse dans les poteaux balcon
ou les platines à visser.

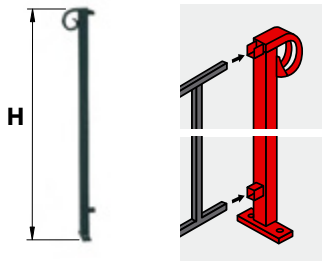
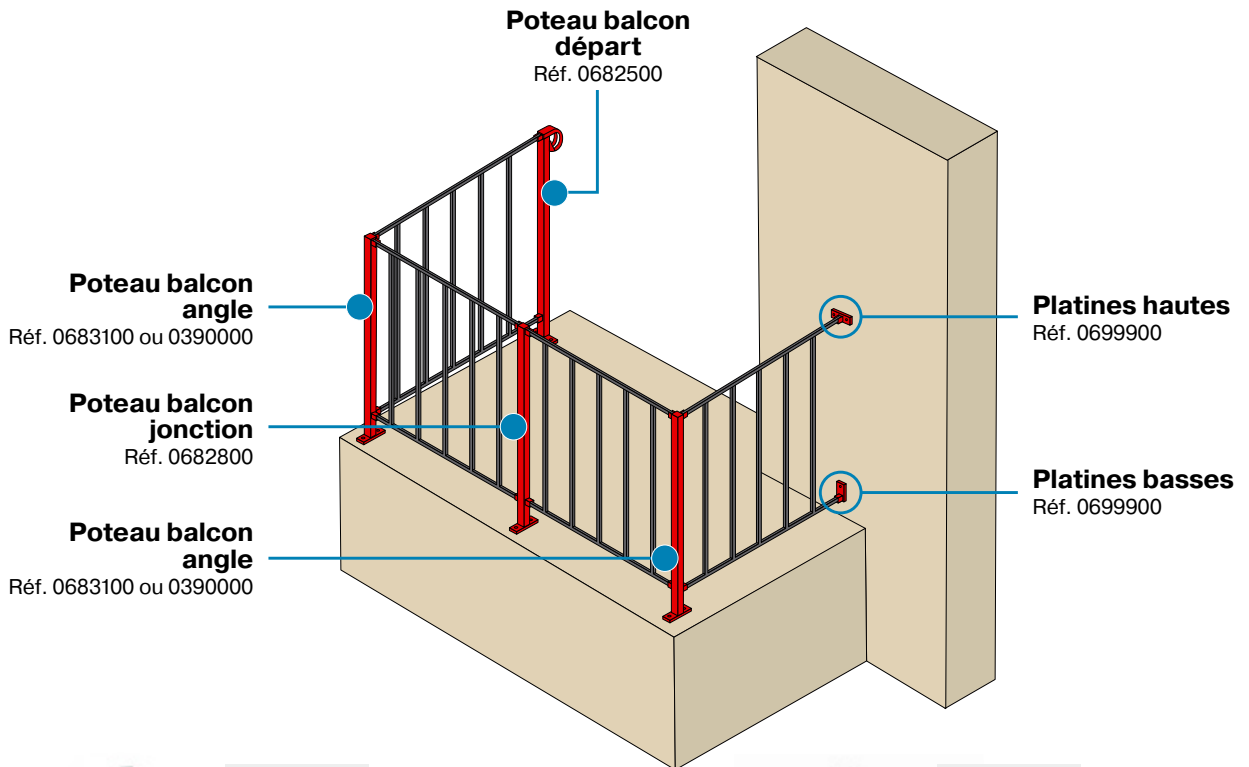

Poteau balcon départ à visser

Code	Gencod	H	Type packaging
0682500	3308186825002	1070	Vrac gencodé

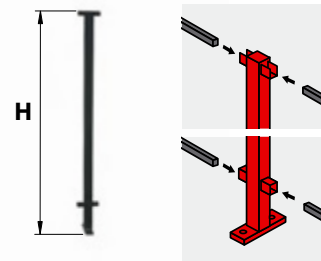

Poteau balcon jonction à visser

Code	Gencod	H	Type packaging
0682800	3308186828003	1070	Vrac gencodé

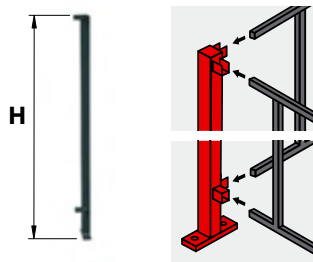

Poteau balcon angle à visser

Code	Gencod	H	Type packaging
0683100	3308186831003	1070	Vrac gencodé

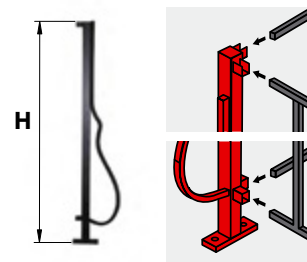

Poteau balcon angle Lombarde à visser

Code	Gencod	H	Type packaging
0390000	3308183900009	1070	Vrac gencodé

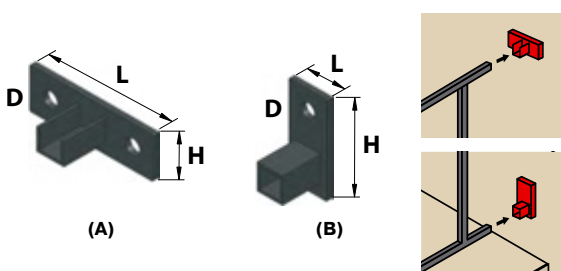

Platine à visser pour poteau balcon (x2)

Code	Gencod	D	A L x H	B L x H	Type packaging
1 platine haute (A) + 1 platine basse (B) pour carré 14 mm					
0699900	3308186999000	10,5	90 x 30	30 x 70	Vrac gencodé

Caractéristiques





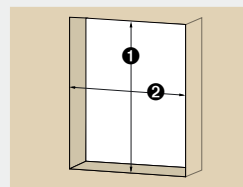

- Peinture primaire antirouille noire
- Fabrication Française 
- Délai 4 semaines

Prise de cotes

Relevez :
 ❶ la hauteur : H
 ❷ la largeur : L
 correspondant à l'ouverture,
 en l'exprimant en mm.
 ex : H = 2000 x L = 900









Grille ouvrante 1 vantail / m²

Code	Gencod		Type packaging 
Levant			
0683200	3308186832000		Vrac gencodé 1
Mistral			
0683300	3308186833007		Vrac gencodé 1
Nordet			
0683400	3308186834004		Vrac gencodé 1
Ponant			
0683500	3308186835001		Vrac gencodé 1



Grille ouvrante 2 vantaux / m²

Code	Gencod		Type packaging 
Levant			
0364500	3308183645009		Vrac gencodé 1
Mistral			
0364600	3308183646006		Vrac gencodé 1
Nordet			
0364900	3308183649007		Vrac gencodé 1
Ponant			
0365300	3308183653004		Vrac gencodé 1



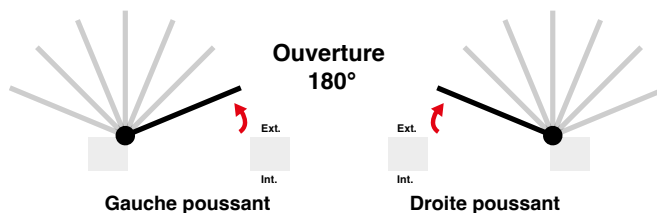



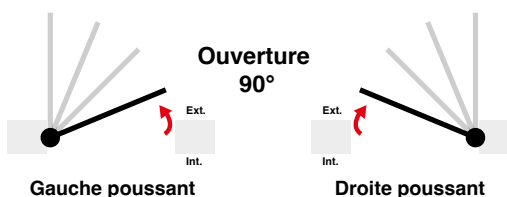









POSE EN EMBRASURE



POSE EN TUNNEL



AFBAT Sécurité vous offre la possibilité de commander, en toute simplicité, plus de 600 références standards parmi 6 gammes et 17 modèles de grilles.

MODÈLE	GRILLES		Oeils-de-bœuf	Barres d'appui	Balconnets	Balcons	Grilles ouvrantes
	Code	Gencod					
LEVANT 	0630200	3308186302008	X	X	X	X	X
PONANT 	0630300	3308186303005					X
MISTRAL 	0630400	3308186304002	X		X	X	X
NORDET 	0630500	3308186305009	X		X	X	X
GALERNE 	0631300	3308186313004		X	X		
AUTAN 	0632600	3308186326004	X				
TRAMONTANE 	0554500	3308185545000	X	X			
LOMBARDE <i>Pose Tableau</i> 	0554600	3308185546007			X	X	
LOMBARDE <i>Pose Facade</i> 	0559600	3308185596002					
AQUILON 	0587100	3308185871000					
ZEPHYR 	0587700	3308185877002					
SOLANO NOUVEAU 	0587800	3517655878009	X		X	X	X
MARINE NOUVEAU 	0587900	3517655879006			X		X
LIBECCIO NOUVEAU 	0588000	3517655880002					
VENDÉE NOUVEAU 	0588100	3517655881009			X		X
BORA NOUVEAU 	0588200	3517655882006			X		X
ASTRALE NOUVEAU 	0588300	3517655883003			X		X

Ferbel Express Mode d'emploi :
à l'aide d'un bon de commande, rien de plus simple...

FERBEL® Express vous permet d'adapter les grilles aux spécificités de vos clients grâce à nos bons de commande modélisés disponibles ci-dessous ou sur simple demande auprès de notre service commercial au : 0 555 519 250.

1 Reportez la référence de la grille à modifier et précisez vos côtes spécifiques

2 Choisissez la pose

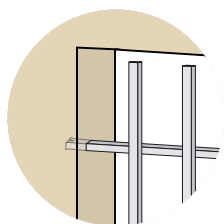

A sceller en tableau STANDARD

Les grilles sont vendues de base avec une pose à sceller en tableau.

Pour la commande, saisir le code de la grille désirée sur votre bon de commande.
Pour les grilles, garde-corps et œils-de-bœuf uniquement.

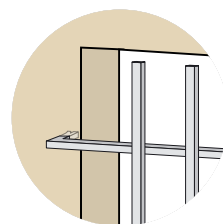

A sceller en façade Code 0680500

Pour la commande, saisir le code ci-dessus en plus du code de la grille désirée sur votre bon de commande.
Pour les grilles, garde-corps et œils-de-bœuf uniquement (Sauf pour la grille Lombarde à sceller en façade).

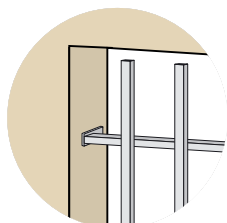

Sur platine à visser en tableau Code 0679800

Pour la commande, saisir le code ci-dessus en plus du code de la grille désirée sur votre bon de commande.
Ne concerne pas les garde-corps.

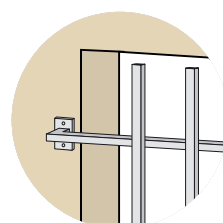

Sur platine à visser en façade Code 0680500 + 0679800

Pour la commande, saisir les 2 codes ci-dessus en plus du code de la grille désirée sur votre bon de commande.
Ne concerne pas les garde-corps.

3 Choisissez le cintrage*

*Sauf Aquilon, Zéphyr, Lebeccio, Vendée, Bora et Astrale.

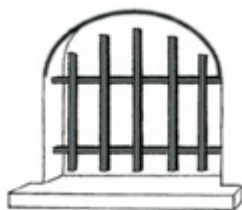

Plein cintre

Code 0679600



Flèche (100 mm)

Code 0680200



Flèche (150 mm)

Code 0692500

4 Choisissez la finition

Toutes nos grilles et accessoires sont livrés avec une peinture primaire noire anti-rouille. Nous vous recommandons fortement l'application d'une finition antirouille, afin de préserver votre produit dans le temps.

Thermolaquage - une solution protectrice et esthétique !

Ce procédé permet non seulement de bénéficier d'un système anticorrosion des plus résistants mais aussi d'obtenir une finition peinture de haute qualité.

BLANC 9016	ROUGE BASQUE 3004	NOIR 9005	BLEU PROVENCE 5012	VERT AMANDE 6021	BLEU ATLANTIQUE 5003	GRIS ANTHRACITE 7016
Code 0677800	Code 0680800	Code 0680700	Code 0679400	Code 0680900	Code 0678000	Code 0677900

Galvanisation - une solution efficace et économique !

Ce procédé anticorrosion est l'un des plus résistants.

Conseil : il est conseillé de brosser et dégraisser la grille avec un acide léger approprié avant de lui appliquer une peinture «spéciale galvanisation» ou bien encore un primaire puis une peinture de finition.



Code 0680600

Attention : en fonction des gammes et modèles, toutes les options ne sont pas réalisables.

5 Options

Avec quelle vis visser sa grille ?

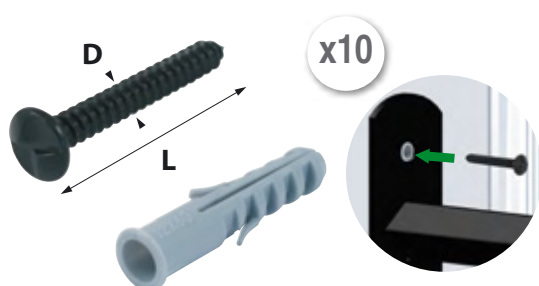

Vis indévissables + chevilles (x10)

Code	D	L	Type packaging
84266391	8	60	Brochable gencodé 1

Code à rajouter à votre commande.

Commande sur-mesure

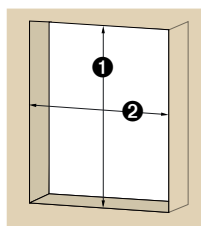

Toutes nos grilles peuvent être adaptées aux besoins :

- aux dimensions spéciales
- aux couleurs spécifiques

Pour la commande, adressez un mail à info@afbat.com ou téléphonez au 05 55 51 92 50 où les délais et coûts vous seront communiqués.

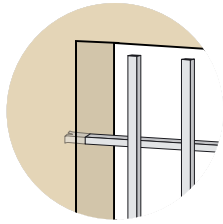

Ferbel / m²

Code	Gencod		Type packaging	
0677800	3308186778001	9016	Vrac gencodé	1
0680700	3308186807008	9005	Vrac gencodé	1
0678000	3308186780004	5003	Vrac gencodé	1
0679400	3308186794001	5012	Vrac gencodé	1
0680800	3308186808005	3004	Vrac gencodé	1
0680900	3308186809002	6021	Vrac gencodé	1
0677900	3308186779008	7016	Vrac gencodé	1

Ferbel galvanisation grille / m²

Code	Gencod	Type packaging	
0680600	3308186806001	Vrac gencodé	1

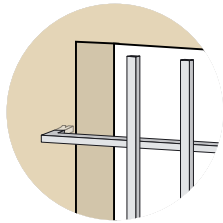

Ferbel forfait pose façade

Code	Gencod	Type packaging	
0680500	3308186805004	Vrac gencodé	1

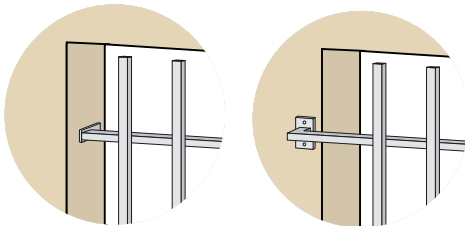

Ferbel forfait fixation platine

Code	Gencod	Type packaging	
0679800	3308186798009	Vrac gencodé	1

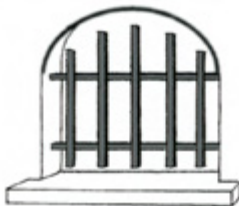

Ferbel forfait plein cintre

Code	Gencod	Type packaging	
0679600	3308186796005	Vrac gencodé	1



Ferbel forfait cintre flèche

Code	Gencod	
100 mm		
0680200	3308186802003	1
150 mm		
0692500	3308186925009	1

Ferbel option livraison 10 jours

Code	Gencod	Type packaging	
0700000	3308187000002	Vrac gencodé	-

AIDE À LA DÉCISION - GRILLES DE FENÊTRE

AFBAT

ZI Cher du Prat
23000 GUERET
Tél : +33 5 55 51 92 50
info@afbat.com

Date : : : 20...
Magasin :
Nom client :
Réf. Commande client :
Réf. Commande :

1 BON DE COMMANDE = 1 GRILLE

SPECIAL GRILLES HORS COTE / STANDARD ET OPTIONS

Reportez les cotes, hors standard

➔ H : _____ mm

➔ L : _____ mm

PRISE DE COTES

Relevez :

- la hauteur : H
 - la largeur : L
- de l'ouverture
en l'exprimant en mm.
(ex : H = 600 x L = 400)

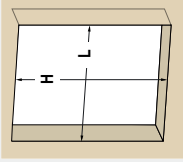

1 Choisissez et cochez votre modèle :

Pour toute option sur une grille standard codifiée, passez directement à l'étape ③

<input type="checkbox"/>	Levant	0630200	<input type="checkbox"/>	Ponant	0680300	<input type="checkbox"/>	Mistral	0630400	<input type="checkbox"/>	Nordet	0630500	<input type="checkbox"/>	Galerie	0631300	<input type="checkbox"/>	Autan	0632600	<input type="checkbox"/>	Tramontane	0554500	<input type="checkbox"/>	Lombarde	0554600	<input type="checkbox"/>	Lombarde	0559600	<input type="checkbox"/>	Aquilon	0587100	<input type="checkbox"/>	Zéphyr	0587700	<input type="checkbox"/>	Solano	0587800	<input type="checkbox"/>	Marine	0587900	<input type="checkbox"/>	Libeccio	0588000	<input type="checkbox"/>	Vendée	0588100	<input type="checkbox"/>	Bora	0588200	<input type="checkbox"/>	Astrale	0588300
--------------------------	--------	---------	--------------------------	--------	---------	--------------------------	---------	---------	--------------------------	--------	---------	--------------------------	---------	---------	--------------------------	-------	---------	--------------------------	------------	---------	--------------------------	----------	---------	--------------------------	----------	---------	--------------------------	---------	---------	--------------------------	--------	---------	--------------------------	--------	---------	--------------------------	--------	---------	--------------------------	----------	---------	--------------------------	--------	---------	--------------------------	------	---------	--------------------------	---------	---------

Tableau Façade

S = H x L : _ _ , _ _ m²

2 Calculez la surface

3 Conservez la pose entre tableau

OU choisissez

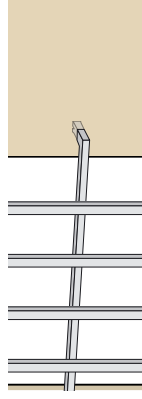

La pose façade

- Forfait : Réf. 0680500

sauf pour modèle Lombarde pose façade

4 Conservez la fixation à sceller

OU choisissez

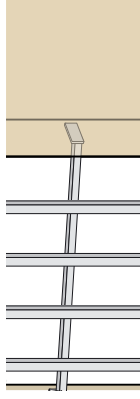

La fixation vissée sur platine

- Forfait : Réf. 0679800

5 Option cintrage*

Plein cintre Réf. 0679600 / Flèche de 100 Réf. 0680200 / Flèche de 150 Réf. 0692500 (*Sauf Aquilon, Zéphyr, Libeccio, Vendée, Bora et Astrale.)

6 Conservez la finition de base

(Peinture primaire noire antirouille)

OU choisissez

Galvanisation Garantie 5 ans (aspect gris) Réf. 0680600

Thermolaquage Garantie 10 ans - Cochez la couleur :

Blanc - RAL 9016
Réf. 0677800

Rouge Basque - RAL 3004
Réf. 0680800

Vert Amande - RAL 6021
Réf. 0680900

Noir - RAL 9005
Réf. 0680700

Bleu Provence - RAL 5012
Réf. 0679400

Bleu Atlantique - RAL 5003
Réf. 0678000

Gris anthracite - RAL 7016
Réf. 0677900

7 Livraison Express

Forfait Réf. 0700000 (livraison en 10 jours max.)

Comment traiter sa grille ?

Conseils

Nos grilles sont livrées avec une peinture primaire antirouille noire.

Finition à repeindre pour une meilleure tenue dans le temps.

Une fois la grille posée, protégez l'encadrement de la fenêtre afin d'éviter tout dommage.

Nettoyez la grille à l'aide d'une brosse souple.

Peignez en suivant le sens des barreaux et traverses.

Passez plusieurs couches mais attention à ne pas remplir les creux des parties décoratives.

Vérifiez depuis l'intérieur et l'extérieur que toute la surface a été peinte.

Matériel

Peinture pour métaux application extérieure.

Pinceaux à bout arrondi.

Brosse souple.

Bon à savoir

Barres d'appui, balconnets

Pour le choix et la mise en oeuvre des balconnets et barres d'appui, nous vous recommandons fortement de vous référer à la norme NF P01-012.

Garde-corps

Il en existe 4 types : arrivée/départ, jonction et angle (1 standard et un spécial Lombarde).

Ils sont équipés de supports sur lesquels viennent se loger les traverses des garde-corps.

Aucune soudure n'est nécessaire : la fixation des poteaux au sol permet de solidariser le garde-corps.

Le positionnement des supports d'ancrage fixe la hauteur de la rampe à 1070 mm.

Un jeu de platines avec support permet de fixer le garde-corps sur les murs. Le garde-corps peut alors être vissé sur platines ou scellé, avec découpe, si nécessaire.

Pour le choix et la mise en oeuvre des garde-corps, nous vous recommandons fortement de vous référer à la norme NF P01-012.



L'EXTÉRIEUR DE L'HABITAT

LA FERRONNERIE

LA FERRONNERIE

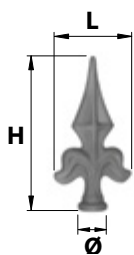

Fer de lance 00

Code	Gencod		Ø	L	H	Type packaging	
FDL00R20AF	3308187790651	BRUT	20	58	115	Vrac gencodé	1
FDL00R26AF	3308187790668	BRUT	26	70	140	Vrac gencodé	1

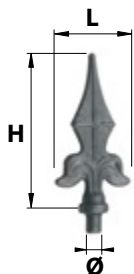

Fer de lance 01

Code	Gencod		Ø	L	H	Type packaging	
FDL01R12AF	3308187790675	BRUT	12	60	130	Vrac gencodé	1
FDL01R17AF	3308187790682	BRUT	17	70	155	Vrac gencodé	1
FDL01R20AF	3308187790699	BRUT	20	95	190	Vrac gencodé	1

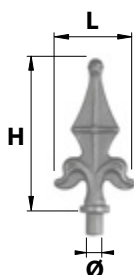

Fer de lance 14

Code	Gencod		Ø	L	H	Type packaging	
FDL14R12AF	3308187790781	BRUT	12	60	130	Vrac gencodé	1
FDL14R16AF	3308187790798	BRUT	16	70	155	Vrac gencodé	1

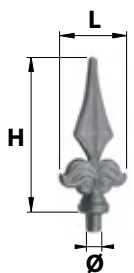

Fer de lance 02

Code	Gencod		Ø	L	H	Type packaging	
FDL02R13AF	3308187790705	BRUT	13	60	125	Vrac gencodé	1
FDL02R16AF	3308187790712	BRUT	16	70	150	Vrac gencodé	1
FDL02R20AF	3308187790729	BRUT	20	90	190	Vrac gencodé	1

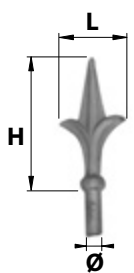

Fer de lance 17

Code	Gencod		Ø	L	H	Type packaging	
FDL17R13AF	3308187790835	BRUT	13	53	130	Vrac gencodé	1
FDL17R17AF	3308187790842	BRUT	17	65	160	Vrac gencodé	1
FDL17R171A	3308187790859	BRUT	17	75	195	Vrac gencodé	1

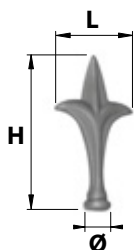

Fer de lance 20

Code	Gencod		Ø	L	H	Type packaging	
FDL20R20AF	3308187790880	BRUT	20	60	110	Vrac gencodé	1

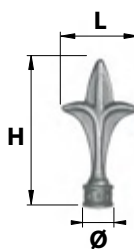

Fer de lance 21

Code	Gencod		Ø	L	H	Type packaging	
FDL21R16AF	3308187790897	BRUT	16	70	155	Vrac gencodé	1

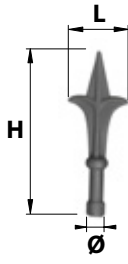

Fer de lance 22

Code	Gencod		Ø	L	H	Type packaging	
FDL22R15AF	3308187790903	BRUT	15	50	130	Vrac gencodé	1

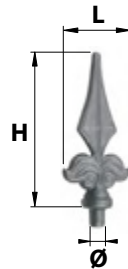

Fer de lance 16

Code	Gencod		Ø	L	H	Type packaging	
FDL16R12AF	3308187790828	BRUT	12	60	135	Vrac gencodé	1

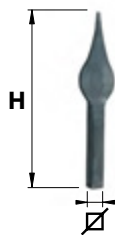

Fer de lance 41

Code	Gencod		Ø	H	Type packaging	
FDL41C16AF	3308187791061	BRUT	16	200	Vrac gencodé	1

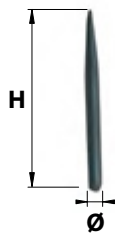

Fer de lance 45

Code	Gencod		Ø	H	Type packaging	
FDL45R16AF	3308187791092	BRUT	16	200	Vrac gencodé	1
FDL45R20AF	3308187791108	BRUT	20	200	Vrac gencodé	1

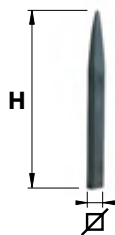

Fer de lance 42

Code	Gencod		Ø	H	Type packaging	
FDL42C16AF	3308187791078	BRUT	16	200	Vrac gencodé	1
FDL42C20AF	3308187791085	BRUT	20	200	Vrac gencodé	1

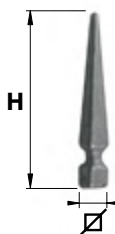

Fer de lance 12

Code	Gencod		Ø	H	Type packaging	
FDL12C25AF	3308187790774	BRUT	25	155	Vrac gencodé	1

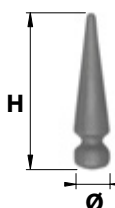

Fer de lance 03

Code	Gencod		Ø	H	Type packaging	
FDL03R28AF	3308187790736	BRUT	28	110	Vrac gencodé	1
FDL03R31AF	3308187790743	BRUT	31	140	Vrac gencodé	1

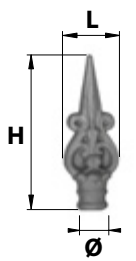

Fer de lance 23

Code	Gencod		L	Ø	H	Type packaging	
FDL23R25AF	3308187790934	BRUT	25	45	125	Vrac gencodé	1
FDL23R33AF	3308187790941	BRUT	33	57	140	Vrac gencodé	1

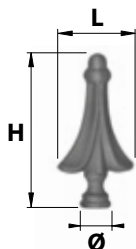

Fer de lance 15

Code	Gencod		Ø	L	H	Type packaging	
FDL15R38AF	3308187790811	BRUT	38	80	137	Vrac gencodé	1

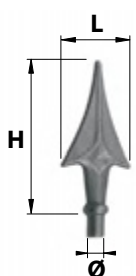

Fer de lance 04

Code	Gencod		Ø	H	Type packaging	
FDL04R16AF	3308187790750	BRUT	16	155	Vrac gencodé	1

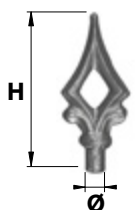

Fer de lance 24

Code	Gencod		Ø	H	Type packaging	
FDL24R12AF	3308187790910	BRUT	12	100	Vrac gencodé	1
FDL24R15AF	3308187790927	BRUT	15	125	Vrac gencodé	1

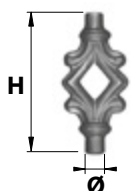

Fer de lance 25

Code	Gencod		Ø	H	Type packaging	
FDL25R12AF	3308187790965	BRUT	12	100	Vrac gencodé	1
FDL25R15AF	3308187790958	BRUT	15	125	Vrac gencodé	1

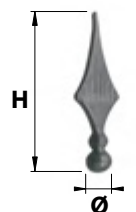

Fer de lance 19

Code	Gencod		Ø	H	Type packaging	
FDL19R28AF	3308187790866	BRUT	28	175	Vrac gencodé	1
FDL19R35AF	3308187790873	BRUT	35	175	Vrac gencodé	1

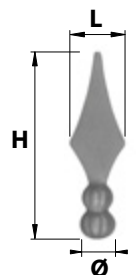

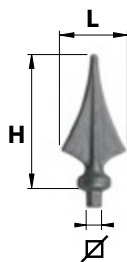

Fer de lance 26

Code	Gencod		Ø	L	H	Type packaging	
FDL26R25AF	3308187790972	BRUT	25	40	135	Vrac gencodé	1
FDL26R30AF	3308187790989	BRUT	30	50	160	Vrac gencodé	1
FDL26R32AF	3308187790996	BRUT	32	55	190	Vrac gencodé	1



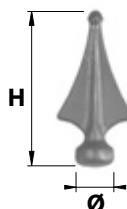

Fer de lance 05

Code	Gencod		Ø	L	H	Type packaging	
FDL05C14AF	3308187790767	BRUT	14	60	140	Vrac gencodé	1



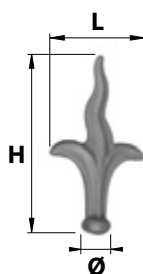

Fer de lance 27

Code	Gencod		Ø	H	Type packaging	
FDL27R25AF	3308187791009	BRUT	25	110	Vrac gencodé	1
FDL27R32AF	3308187791016	BRUT	32	125	Vrac gencodé	1



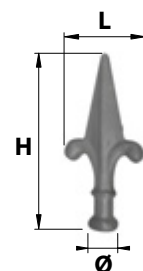

Fer de lance 29

Code	Gencod		Ø	L	H	Type packaging	
FDL29R20AF	3308187791023	BRUT	20	70	130	Vrac gencodé	1
FDL29R30AF	3308187791030	BRUT	30	90	140	Vrac gencodé	1



Fer de lance 33

Code	Gencod		Ø	L	H	Type packaging	
FDL33R20AF	3308187791047	BRUT	20	55	120	Vrac gencodé	1
FDL33R25AF	3308187791054	BRUT	25	65	135	Vrac gencodé	1



Ornement 54 estampé

Code	Gencod		Ø	L	H	Type packaging	
OGC54R14AF	3308187791306	BRUT	14	36	135	Vrac gencodé	1
OGC54R16AF	3308187791290	BRUT	16	36	135	Vrac gencodé	1



Ornement 09 estampé

Code	Gencod		Ø	L	H	Type packaging	
OGC09R14AF	3308187791191	BRUT	14	23	120	Vrac gencodé	1
OGC09R16AF	3308187791207	BRUT	16	33	120	Vrac gencodé	1



Ornement 08 estampé

Code	Gencod		Ø	L	H	Type packaging	
OGC08R14AF	3308187791177	BRUT	14	33	64	Vrac gencodé	1
OGC08R16AF	3308187791184	BRUT	16	33	64	Vrac gencodé	1

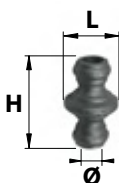

Ornement 05 estampé

Code	Gencod		Ø	L	H	Type packaging	
OGC05R14AF	3308187791160	BRUT	14	40	67	Vrac gencodé	1



Ornement 49 estampé

Code	Gencod		Ø	L	H	Type packaging	
OGC49C14AF	3308187791252	BRUT	14	45	67	Vrac gencodé	1
OGC49C16AF	3308187791269	BRUT	16	45	67	Vrac gencodé	1

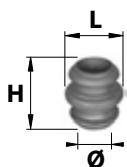

Ornement 24

Code	Gencod		Ø	L	H	Type packaging	
OGC24R40AF	3308187791245	BRUT	40	69	80	Vrac gencodé	1

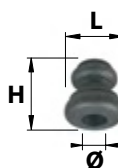

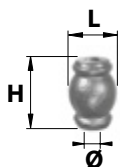

Ornement 04 forgé

Code	Gencod		Ø	L	H	Type packaging	
OGC04R14AF	3308187791153	BRUT	14	37	36	Vrac gencodé	1



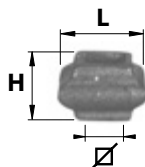

Ornement 23

Code	Gencod		Ø	L	H	Type packaging	
OGC23R12AF	3308187791214	BRUT	12	35	55	Vrac gencodé	1
OGC23R14AF	3308187791221	BRUT	14	35	55	Vrac gencodé	1
OGC23R16AF	3308187791238	BRUT	16	35	55	Vrac gencodé	1



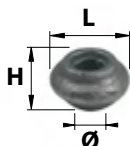

Ornement 53 estampé

Code	Gencod		Ø	L	H	Type packaging	
OGC53C12AF	3308187791283	BRUT	12	33	22	Vrac gencodé	1
OGC53C14AF	3308187791276	BRUT	14	38	22	Vrac gencodé	1



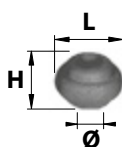

Ornement 03 tourné

Code	Gencod		Ø	L	H	Type packaging	
OGC03TR14A	3308187791139	BRUT	14	40	22	Vrac gencodé	1
OGC03TR16A	3308187791146	BRUT	16	40	22	Vrac gencodé	1



Ornement 03 forgé

Code	Gencod		Ø	L	H	Type packaging	
OGC03R12AF	3308187791122	BRUT	12	35	25	Vrac gencodé	1
OGC03R14AF	3308187791115	BRUT	14	35	25	Vrac gencodé	1

Cache-scellements



Cache-scellement 10

Code	Gencod		Ø	H	Type packaging	
OCA10R12AF	3308187790545	BRUT	120	22	Vrac gencodé	1

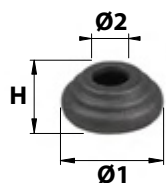

Cache-scellement 03

Code	Gencod		Ø1	Ø2	H	Type packaging	
OCA03R16AF	3308187790514	BRUT	50	16	20	Vrac gencodé	1
OCA03R20AF	3308187790521	BRUT	50	20	20	Vrac gencodé	1
OCA03R30AF	3308187790538	BRUT	60	30	20	Vrac gencodé	1

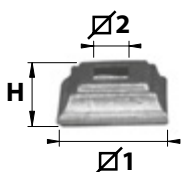

Cache-scellement 01

Code	Gencod		Ø1	Ø2	H	Type packaging	
OCA04C35AF	3308187790453	BRUT	35	12	20	Vrac gencodé	1
OCA00C12AF	3308187790446	BRUT	40	12	20	Vrac gencodé	1
OCA00C14AF	3308187790439	BRUT	40	14	20	Vrac gencodé	1
OCA00C16AF	3308187790415	BRUT	40	16	20	Vrac gencodé	1
OCA02C20AF	3308187790408	BRUT	50	20	20	Vrac gencodé	1
OCA01C25AF	3308187790392	BRUT	60	25	20	Vrac gencodé	1
OCA01C30AF	3308187790385	BRUT	80	30	20	Vrac gencodé	1
OCA01C35AF	3308187790378	BRUT	80	35	20	Vrac gencodé	1
OCA01C40AF	3308187790507	BRUT	80	40	20	Vrac gencodé	1

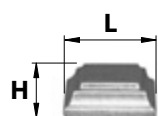

Cache-scellement 13

Code	Gencod		L	H	Type packaging	
OCA13C80AF	3308187790422	BRUT	80	20	Vrac gencodé	1

Couvre-pilastres

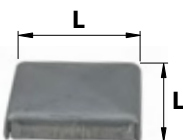

Couvre-pilastre 02

Code	Gencod		L	Type packaging	
OCP02C40AF	3308187790576	BRUT	40	Vrac gencodé	1

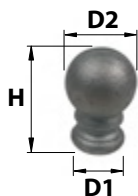

Couvre-pilastre 11

Code	Gencod		Ø1	Ø2	H	Type packaging	
OCP11R55AF	3308187790583	BRUT	55	45	85	Vrac gencodé	1



Couvre-pilastre 15

Code	Gencod		Ø	H	Type packaging	
OCP15R90AF	3308187790590	BRUT	90	200	Vrac gencodé	1

Boules



Boule 01

Code	Gencod		Ø	Type packaging	
OB001R25AF	3308187790460	BRUT	25	Vrac gencodé	1
OB001R30AF	3308187790477	BRUT	30	Vrac gencodé	1
OB001R40AF	3308187790484	BRUT	40	Vrac gencodé	1
OB001R50AF	3308187790491	BRUT	50	Vrac gencodé	1

Volutes

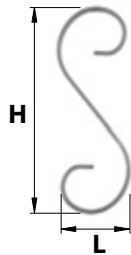

Volute 74

Code	Gencod		L	H	l	e	Type packaging	
VOL74P12AF	3308187792013	BRUT	90	270	12	5	Vrac gencodé	1

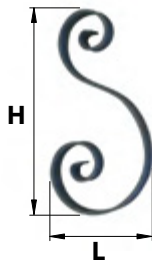

Volute 68

Code	Gencod		L	H	l	e	Type packaging	
VOL68P40AF	3308187791931	BRUT	250	500	40	8	Vrac gencodé	1

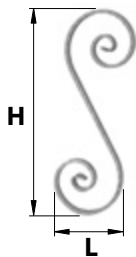

Volute 73

Code	Gencod		L	H	l	e	Type packaging	
VOL73P120A	3308187791993	BRUT	125	290	12	6	Vrac gencodé	1
VOL73P121A	3308187792006	BRUT	130	360	12	6	Vrac gencodé	1

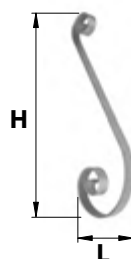

Volute 67

Code	Gencod		L	H	l	e	Type packaging	
VOL67P40AF	3308187791924	BRUT	375	780	40	8	Vrac gencodé	1

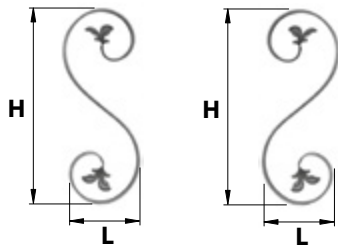

Volute 69

Code	Gencod		L	H	l	e	Type packaging	
------	--------	--	---	---	---	---	----------------	--

Modèle droite

VOL69P120A	3308187791948	BRUT	150	400	12	6	Vrac gencodé	1
------------	---------------	------	-----	-----	----	---	--------------	---

Modèle gauche

VOL69P121A	3308187791955	BRUT	150	400	12	6	Vrac gencodé	1
------------	---------------	------	-----	-----	----	---	--------------	---



Volute 52

Code	Gencod		L	H	l	e	Type packaging	
------	--------	--	---	---	---	---	----------------	--

VOL52P14AF	3308187791894	BRUT	105	290	14	6	Vrac gencodé	1
------------	---------------	------	-----	-----	----	---	--------------	---

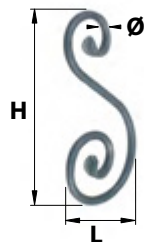

Volute 50

Code	Gencod		L	H	Ø	Type packaging	
------	--------	--	---	---	---	----------------	--

VOL50R12AF	3308187791887	BRUT	110	230	12	Vrac gencodé	1
------------	---------------	------	-----	-----	----	--------------	---

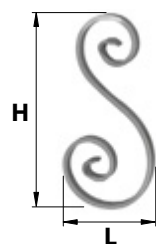

Volute 70

Code	Gencod		L	H	l	e	Type packaging	
------	--------	--	---	---	---	---	----------------	--

VOL70P12AF	3308187791962	BRUT	115	230	12	6	Vrac gencodé	1
------------	---------------	------	-----	-----	----	---	--------------	---

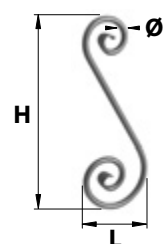

Volute 72

Code	Gencod		L	H	Ø	Type packaging	
------	--------	--	---	---	---	----------------	--

VOL72R12AF	3308187791986	BRUT	130	360	12	Vrac gencodé	1
------------	---------------	------	-----	-----	----	--------------	---

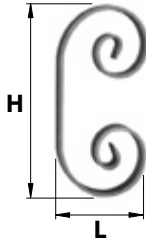

Volute 71

Code	Gencod		L	H	l	e	Type packaging	
VOL71P76AF	3308187791979	BRUT	85	180	16	4	Vrac gencodé	1

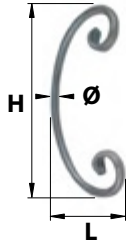

Volute 27

Code	Gencod		L	H	Ø	Type packaging	
VOL27R12AF	3308187791788	BRUT	85	180	12	Vrac gencodé	1

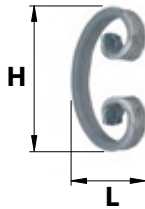

Volute 20

Code	Gencod		L	H	l	e	Type packaging	
VOL20P14AF	3308187791726	BRUT	60	100	14	6	Vrac gencodé	1
VOL20P16AF	3308187791733	BRUT	60	100	16	6	Vrac gencodé	1

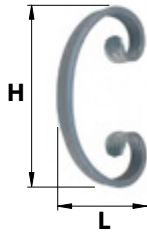

Volute 22

Code	Gencod		L	H	l	e	Type packaging	
VOL22P14AF	3308187791740	BRUT	80	150	14	6	Vrac gencodé	1
VOL22P16AF	3308187791757	BRUT	80	150	16	6	Vrac gencodé	1

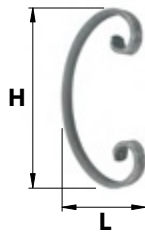

Volute 23

Code	Gencod		L	H	l	e	Type packaging	
VOL23P14AF	3308187791764	BRUT	105	180	14	6	Vrac gencodé	1
VOL23P16AF	3308187791771	BRUT	105	180	16	6	Vrac gencodé	1

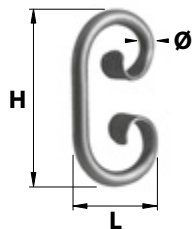

Volute 28

Code	Gencod		L	H	Ø	Type packaging	
VOL28R12AF	3308187791795	BRUT	70	135	12	Vrac gencodé	1

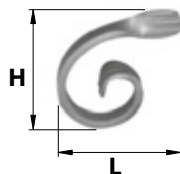

Volute 12

Code	Gencod		L	H	l	e	Type packaging	
VOL12P12AF	3308187791702	BRUT	180	120	12	6	Vrac gencodé	1
VOL12P14AF	3308187791719	BRUT	180	120	14	6	Vrac gencodé	1

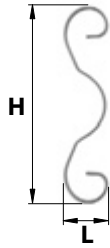

Volute 37

Code	Gencod		L	H	l	e	Type packaging	
VOL37P12AF	3308187791849	BRUT	55	240	12	3	Vrac gencodé	1

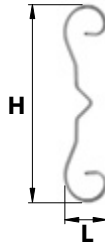

Volute 38

Code	Gencod		L	H	l	e	Type packaging	
VOL38P12AF	3308187791856	BRUT	55	250	12	3	Vrac gencodé	1

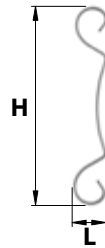

Volute 39

Code	Gencod		L	H	l	e	Type packaging	
VOL39P12AF	3308187791863	BRUT	45	280	12	3	Vrac gencodé	1

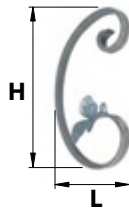

Volute 33 modèle gauche

Code	Gencod		L	H	l	e	Type packaging	
VOL33P12GA	3308187791801	BRUT	125	200	12	6	Vrac gencodé	1

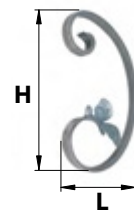

Volute 36 modèle droite

Code	Gencod		L	H	l	e	Type packaging	
VOL36P12DA	3308187791832	BRUT	125	200	12	6	Vrac gencodé	1

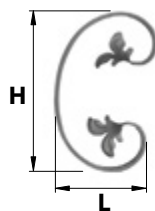

Volute 34

Code	Gencod		L	H	l	e	Type packaging	
VOL34P12AF	3308187791818	BRUT	150	205	12	6	Vrac gencodé	1
VOL34P121A	3308187791825	BRUT	150	250	12	6	Vrac gencodé	1

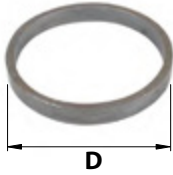

Motif 74

Code	Gencod		Ø	l	e	Type packaging	
MOT74P14AF	3308187791436	BRUT	110	14	6	Vrac gencodé	1
MOT74P20AF	3308187791443	BRUT	110	20	6	Vrac gencodé	1

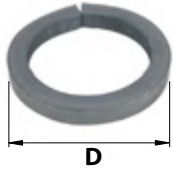

Motif 77

Code	Gencod		Ø	l	e	Type packaging	
MOT77P20AF	3308187791474	BRUT	100	20	6	Vrac gencodé	1

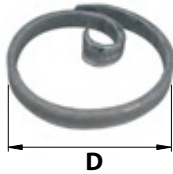

Motif 76

Code	Gencod		Ø	l	e	Type packaging	
MOT76P14AF	3308187791450	BRUT	110	14	6	Vrac gencodé	1
MOT76P16AF	3308187791467	BRUT	110	20	6	Vrac gencodé	1

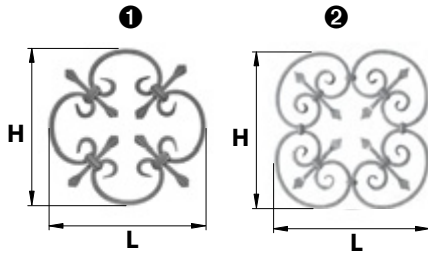

Motif 09

Code	Gencod		L	H	l	e	Type packaging	
MOT09P8AF	3308187791405	BRUT	250	250	8	8	Vrac gencodé	1
MOT09P12AF	3308187791399	BRUT	590	590	12	12	Vrac gencodé	1

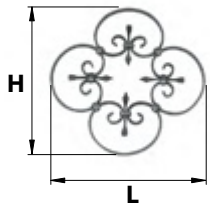

Motif 01

Code	Gencod		L	H	l	e	Type packaging	
MOT01P10AF	3308187791368	BRUT	380	380	10	5	Vrac gencodé	1

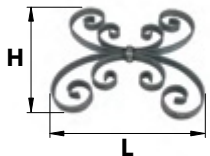

Motif 02

Code	Gencod		L	H	l	e	Type packaging	
MOT02P16AF	3308187791375	BRUT	250	260	16	4	Vrac gencodé	1

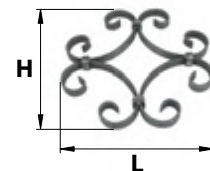

Motif 03

Code	Gencod		L	H	l	e	Type packaging	
MOT03P16AF	3308187791382	BRUT	240	240	16	6	Vrac gencodé	1

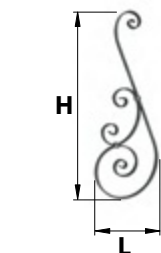



Motif 13

Code	Gencod		L	H	l	e	Type packaging	
MOT13P20AF	3308187791412	BRUT	240	730	20	6	Vrac gencodé	1

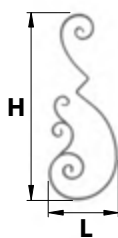
Motifs





Motif 14

Code	Gencod		L	H	l	e	Type packaging	
MOT14P20AF	3308187791429	BRUT	250	700	20	8	Vrac gencodé	1

Clés de tirant



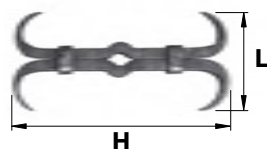

Clé de tirant

Code	Gencod		L	H	l	e	Type packaging	
CDT05P25AF	3308187790569	BRUT	220	920	25	25	Vrac gencodé	1



Clé de tirant

Code	Gencod		L	H	l	e	Type packaging	
CDT03P30AF	3308187790552	BRUT	300	650	30	30	Vrac gencodé	1

Barreaux fantaisies

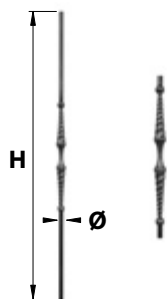

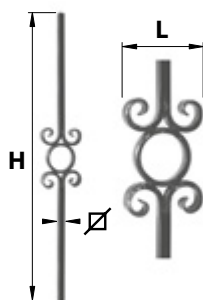

Barreau fantaisie 141

Code	Gencod		Ø	H	Type packaging	
BAF141R12A	3308187790149	BRUT	12	1000	Vrac gencodé	1



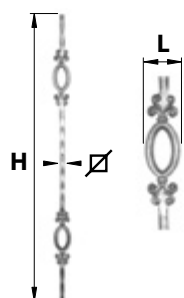

Barreau fantaisie 142 martelé

Code	Gencod		∅	L	H	Type packaging	
BAF142C16A	3308187790156	BRUT	16	135	1000	Vrac gencodé	1



Barreau fantaisie 32 martelé

Code	Gencod		∅	L	H	Type packaging	
BAF32C14AF	3308187790293	BRUT	14	50	1000	Vrac gencodé	1

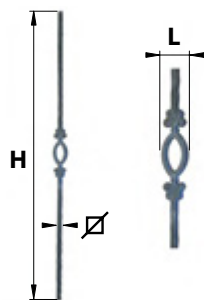

Barreau fantaisie 31 martelé

Code	Gencod		∅	L	H	Type packaging	
BAF31C14AF	3308187790286	BRUT	14	50	1000	Vrac gencodé	1

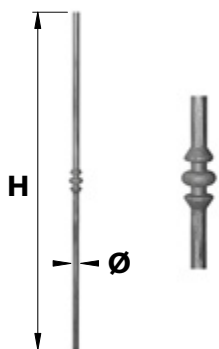

Barreau fantaisie 164

Code	Gencod		∅	H	Type packaging	
BAF164R14A	3308187790170	BRUT	14	1000	Vrac gencodé	1

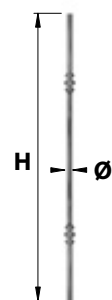

Barreau fantaisie 164 double

Code	Gencod		∅	H	Type packaging	
BAF164R1AF	3308187790187	BRUT	14	1000	Vrac gencodé	1

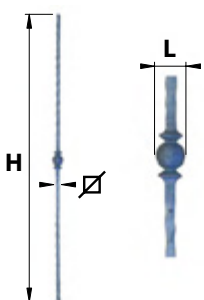

Barreau fantaisie 23 martelé

Code	Gencod		∅	L	H	Type packaging	
BAF23C14AF	3308187790231	BRUT	14	38	1000	Vrac gencodé	1

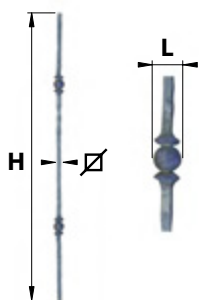

Barreau fantaisie 24 martelé

Code	Gencod		∅	L	H	Type packaging	
BAF24C14AF	3308187790248	BRUT	14	38	1000	Vrac gencodé	1

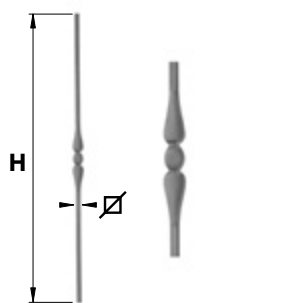

Barreau fantaisie 04

Code	Gencod		Ø	H	Type packaging	
BAF04C14LA	3308187790071	BRUT	14	950	Vrac gencodé	1

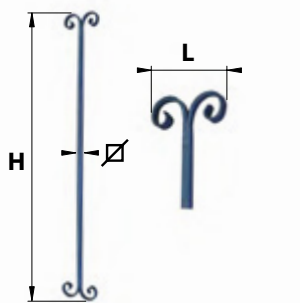

Barreau fantaisie 03

Code	Gencod		Ø	L	H	Type packaging	
BAF03C14LA	3308187790064	BRUT	14	125	950	Vrac gencodé	1

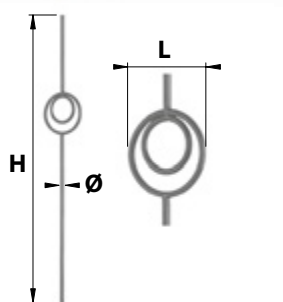

Barreau fantaisie 189

Code	Gencod		Ø	L	H	Type packaging	
BAF189R12A	3308187790194	BRUT	12	135	950	Vrac gencodé	1

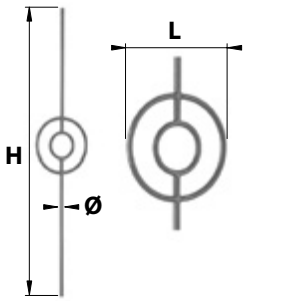

Barreau fantaisie 190

Code	Gencod		Ø	L	H	Type packaging	
BAF190R12A	3308187790200	BRUT	12	185	950	Vrac gencodé	1

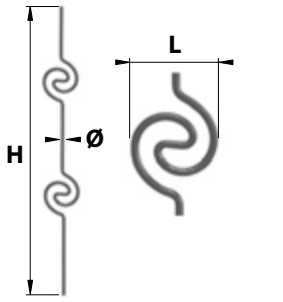

Barreau fantaisie 89 double

Code	Gencod		Ø	L	H	Type packaging	
BAF89R12AF	3308187790361	BRUT	12	100	990	Vrac gencodé	1

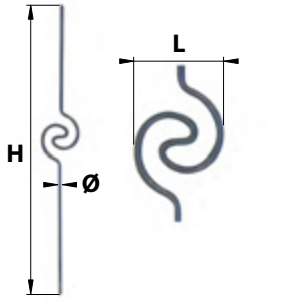

Barreau fantaisie 88

Code	Gencod		Ø	L	H	Type packaging	
BAF88R12AF	3308187790354	BRUT	12	100	990	Vrac gencodé	1

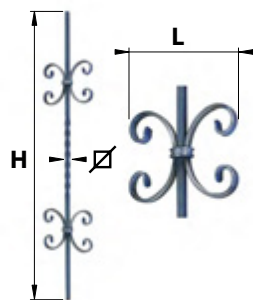

Barreau fantaisie 10 double

Code	Gencod		Ø	L	H	l	e	Type packaging	
BAF10C12AF	3308187790125	BRUT	12	170	950	12	6	Vrac gencodé	1

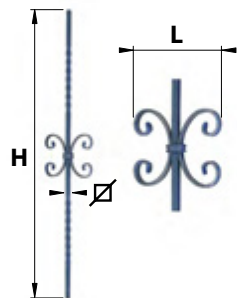

Barreau fantaisie 09

Code	Gencod		Ø	L	H	l	e	Type packaging	
BAF09C12AF	3308187790118	BRUT	12	170	950	12	6	Vrac gencodé	1

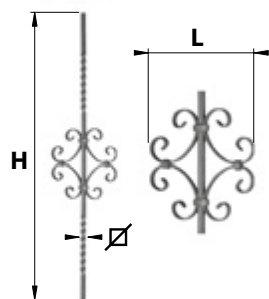

Barreau fantaisie 16

Code	Gencod		Ø	L	H	l	e	Type packaging	
BAF16C12AF	3308187790163	BRUT	12	210	950	12	4	Vrac gencodé	1

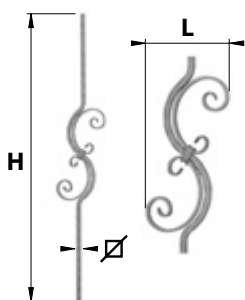

Barreau fantaisie 25

Code	Gencod		Ø	L	H	l	e	Type packaging	
BAF25C12AF	3308187790255	BRUT	12	150	950	12	6	Vrac gencodé	1

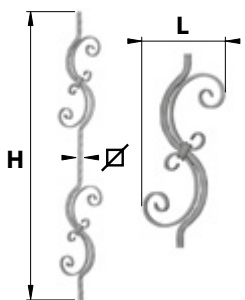

Barreau fantaisie 25 double

Code	Gencod		Ø	L	H	l	e	Type packaging	
BAF25C12DA	3308187790262	BRUT	12	150	950	12	6	Vrac gencodé	1

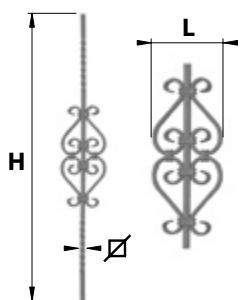

Barreau fantaisie 26

Code	Gencod		Ø	L	H	l	e	Type packaging	
BAF26C12AF	3308187790279	BRUT	12	145	950	12	6	Vrac gencodé	1

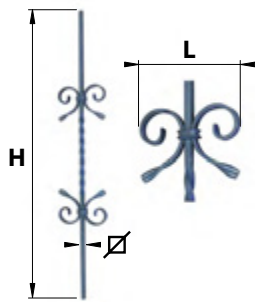

Barreau fantaisie 12

Code	Gencod			L	H	I	e	Type packaging	
BAF12C12AF	3308187790132	BRUT	12	160	950	12	6	Vrac gencodé	1

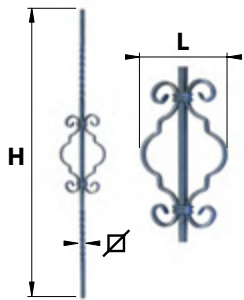

Barreau fantaisie 07

Code	Gencod			L	H	I	e	Type packaging	
BAF07C12AF	3308187790101	BRUT	12	160	950	12	6	Vrac gencodé	1

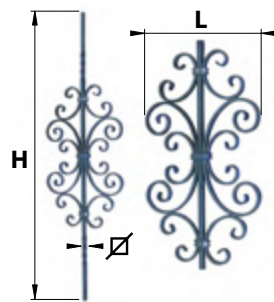

Barreau fantaisie 22

Code	Gencod			L	H	I	e	Type packaging	
BAF22C12AF	3308187790224	BRUT	12	270	950	12	6	Vrac gencodé	1

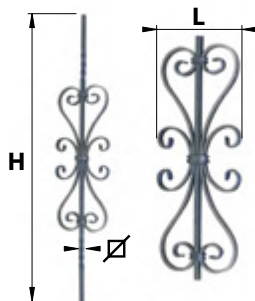

Barreau fantaisie 21

Code	Gencod			L	H	I	e	Type packaging	
BAF21C12AF	3308187790217	BRUT	12	180	950	12	6	Vrac gencodé	1

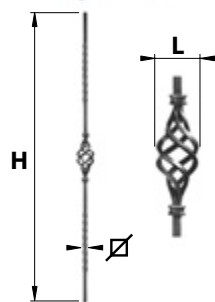

Barreau fantaisie 05

Code	Gencod			L	H	Type packaging	
BAF05C12AF	3308187790088	BRUT	12	60	950	Vrac gencodé	1

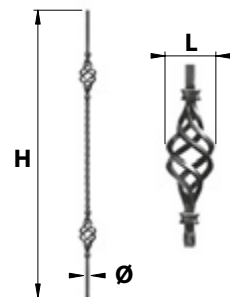

Barreau fantaisie 06 double

Code	Gencod			L	H	Type packaging	
BAF06C12AF	3308187790095	BRUT	12	60	950	Vrac gencodé	1

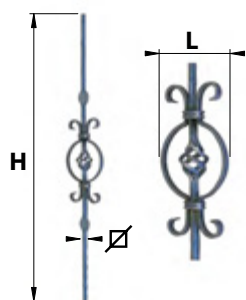

Barreau fantaisie 36 martelé

Code	Gencod		Ø	L	H	l	e	Type packaging	
BAF36C12AF	3308187790309	BRUT	12	135	950	12	6	Vrac gencodé	1

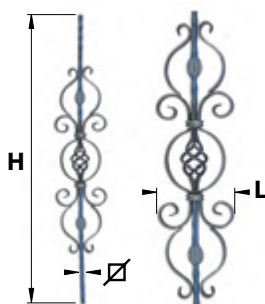

Barreau fantaisie 37 martelé

Code	Gencod		Ø	L	H	l	e	Type packaging	
BAF37C12AF	3308187790316	BRUT	12	175	950	12	6	Vrac gencodé	1

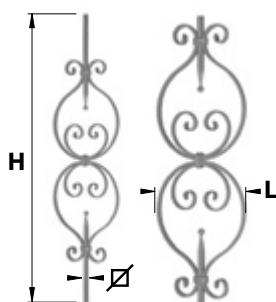

Barreau fantaisie 51

Code	Gencod		Ø	L	H	l	e	Type packaging	
BAF51C12AF	3308187790323	BRUT	12	220	950	12	6	Vrac gencodé	1

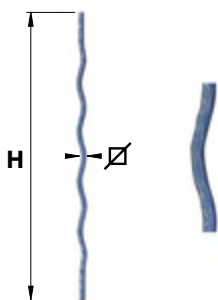

Barreau fantaisie 65 martelé

Code	Gencod		Ø	H	Type packaging	
BAF65C14AF	3308187790347	BRUT	14	950	Vrac gencodé	1

Barreaux clôture

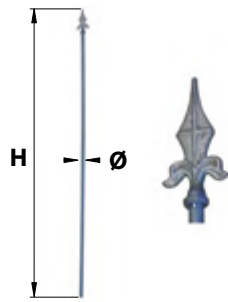

Barreau clôture 15

Code	Gencod		Ø	H	Type packaging	
BAC15R16AF	3308187790019	BRUT	16	1000	Vrac gencodé	1
BAC15R165A	3308187790026	BRUT	16	1500	Vrac gencodé	1

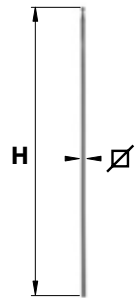

Barreau clôture 16

Code	Gencod		Ø	H	Type packaging	
BAC16C16AF	3308187790033	BRUT	16	1500	Vrac gencodé	1

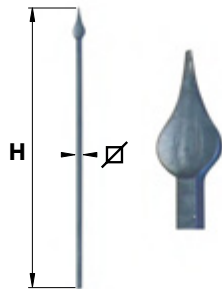

Barreau clôture 22

Code	Gencod		Ø	H	Type packaging	
BAC22C165A	3308187790057	BRUT	16	1500	Vrac gencodé	1
BAC22C16AF	3308187790040	BRUT	16	1000	Vrac gencodé	1

Traverses

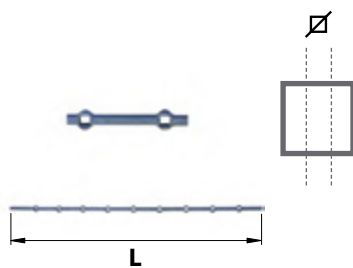

Traverse 83

Code	Gencod		Ø	L	Type packaging	
TRA83C14AF	3308187791672	BRUT	14	2000	Vrac gencodé	1

Nombre de trous : 15
Distance entre trous : 110 mm

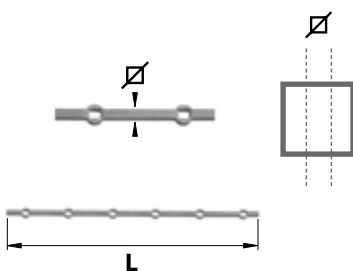

Traverse 85

Code	Gencod		Ø	L	Type packaging	
TRA85C16AF	3308187791689	BRUT	16	2000	Vrac gencodé	1

Nombre de trous : 15
Distance entre trous : 110 mm

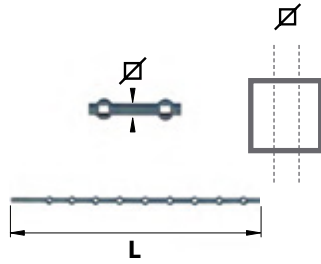

Traverse 86

Code	Gencod		Ø	L	Type packaging	
TRA86C20AF	3308187791696	BRUT	20	2000	Vrac gencodé	1

Nombre de trous : 13
Distance entre trous : 110 mm

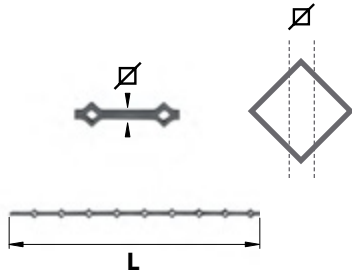

Traverse 01

Code	Gencod		Ø	L	l	e	Type packaging	
TRA01C14AF	3308187791573	BRUT	14	1927	14	15	Vrac gencodé	1

Nombre de trous : 14
Distance entre trous : 110 mm

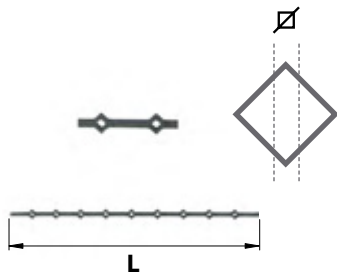

Traverse 11

Code	Gencod		Ø	L	l	e	Type packaging	
TRA11C16AF	3308187791580	BRUT	16	1834	16	15	Vrac gencodé	1

Nombre de trous : 13
Distance entre trous : 110 mm

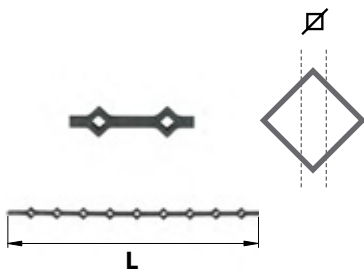

Traverse 26

Code	Gencod		Ø	L	l	e	Type packaging	
TRA26C20AF	3308187791597	BRUT	20	1908	19	20	Vrac gencodé	1

Nombre de trous : 13
Distance entre trous : 110 mm

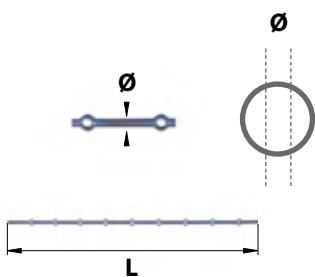

Traverse 80

Code	Gencod		Ø	L	Type packaging	
TRA80R14AF	3308187791641	BRUT	14	2000	Vrac gencodé	1

Nombre de trous : 15
Distance entre trous : 110 mm

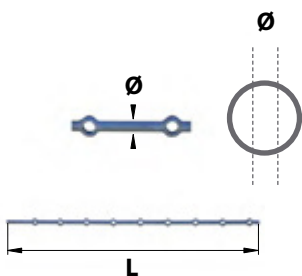

Traverse 81

Code	Gencod		Ø	L	Type packaging	
TRA81R16AF	3308187791658	BRUT	16	2000	Vrac gencodé	1

Nombre de trous : 15
Distance entre trous : 110 mm

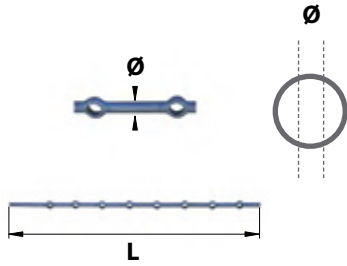

Traverse 82

Code	Gencod		Ø	L	Type packaging		
TRA82R20AF	3308187791665	BRUT	20	2000	Vrac gencodé	1	

Nombre de trous : 13
Distance entre trous : 110 mm

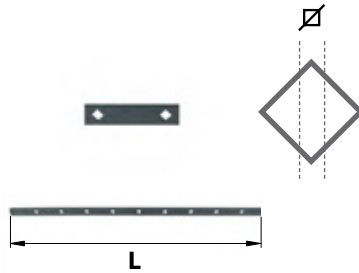

Traverse 50

Code	Gencod			L	l	e	Type packaging		
TRA50C16AF	3308187791603	BRUT	16	2000	40	10	Vrac gencodé	1	

Nombre de trous : 15
Distance entre trous : 110 mm

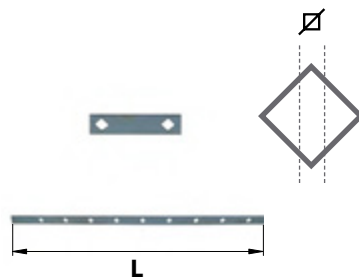

Traverse 60

Code	Gencod			L	l	e	Type packaging		
TRA60C20AF	3308187791627	BRUT	20	2000	45	10	Vrac gencodé	1	

Nombre de trous : 15
Distance entre trous : 110 mm

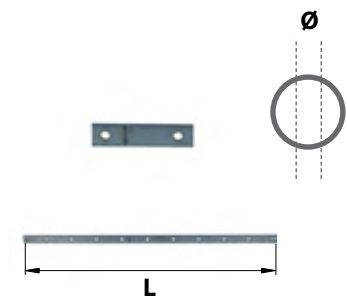

Traverse 57

Code	Gencod		Ø	L	l	e	Type packaging		
TRA57R16AF	3308187791610	BRUT	16	2000	40	10	Vrac gencodé	1	

Nombre de trous : 15
Distance entre trous : 110 mm

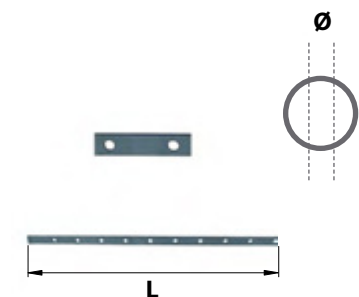

Traverse 67

Code	Gencod		Ø	L	l	e	Type packaging		
TRA67R20AF	3308187791634	BRUT	20	2000	45	10	Vrac gencodé	1	

Nombre de trous : 14
Distance entre trous : 110 mm

Départs de rampe



Départ de rampe 02

Code	Gencod		H	L	l	e	Type packaging	
OMC02P44AF	3308187790606	BRUT	100	330	40	8	Vrac gencodé	1



Départ de rampe 04

Code	Gencod		H	L	l	e	Type packaging	
OMC04P28AF	3308187790613	BRUT	280	400	40	8	Vrac gencodé	1

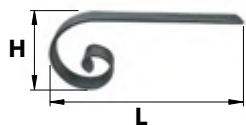

Départ de rampe 05

Code	Gencod		H	L	l	e	Type packaging	
OMC05P40AF	3308187790620	BRUT	180	280	40	8	Vrac gencodé	1

Mains courantes

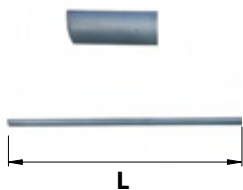

Main courante 17

Code	Gencod		L	l	e	Type packaging	
OMC17PVAF	3308187791344	BRUT	2000	40	8	Vrac gencodé	1

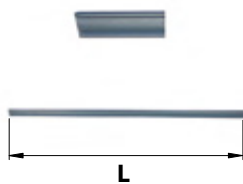

Main courante 03

Code	Gencod		L	l	e	Type packaging	
OMC03PVAF	3308187791337	BRUT	2000	40	8	Vrac gencodé	1

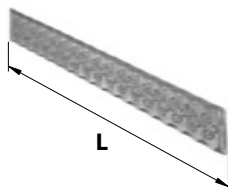

Main courante 32

Code	Gencod		L	l	e	Type packaging	
OMC32PVAF	3308187791351	BRUT	2000	40	8	Vrac gencodé	1

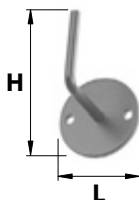



Support main courante 80

Code	Gencod		H	L	Type packaging	
OMC80L21AF	3308187791566	BRUT	215	210	Vrac gencodé	1

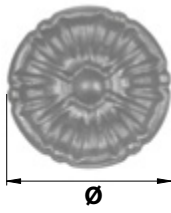
Rosaces



Rosace 06

Code	Gencod		Ø	Type packaging	
OR006R55AF	3308187791528	BRUT	55	Vrac gencodé	1
OR006R90AF	3308187791535	BRUT	90	Vrac gencodé	1
OR006R125A	3308187791542	BRUT	125	Vrac gencodé	1





Rosace 07

Code	Gencod		Ø	Type packaging	
OR007R68AF	3308187791559	BRUT	68	Vrac gencodé	1

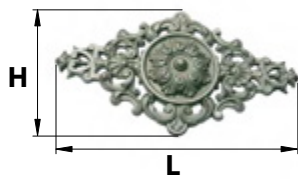
Palmettes



Palmette 02

Code	Gencod		H	L	Type packaging	
OPA02FL3AF	3308187791481	FRONTE	170	300	Vrac gencodé	1
OPA02FL4AF	3308187791498	FRONTE	220	400	Vrac gencodé	1
OPA02FL52A	3308187791504	FRONTE	300	525	Vrac gencodé	1



L'EXTÉRIEUR DE L'HABITAT

LE PORTAIL BATTANT BOIS



RETROUVEZ NOS PENTURES D16 MM
P. 148 - 149 - GAMME VOLET

Gond à sceller réglable

Code	Gencod		D	L	H	Réglage	Type packaging		
L110 mm - Ø14 mm									
0107905	3308181079059		14	110	66	15 / 40	Vrac gencodé		1
0237801	3308182378014		14	110	66	15 / 40			20
L110 mm - Ø16 mm									
0108005	3308181080055		16	110	84	15 / 40	Vrac gencodé		1

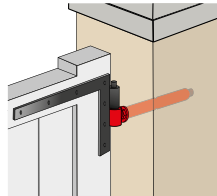
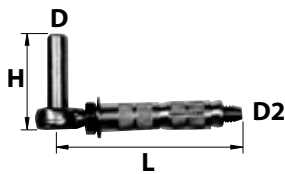
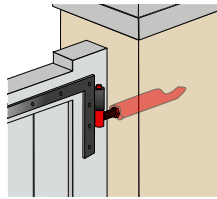
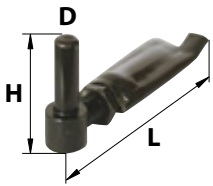

Gond STATEX® + chevilles

Code	Gencod		D	L	D2	H	Type packaging		
L120 mm - Ø14 mm									
I6SX156	3330760037617		14	120	M12	60	Vrac gencodé		1

Gond sur platine réglable bout carré

Code	Gencod		D	L	I	H	Nb trous Réglage & Øvis	Type packaging		
60 x 130 mm - Ø14 mm										
0270001	3308182700013		14	130	60	84	4xØ8,5	30 / 60	Vrac gencodé	1
60 x 130 mm - Ø16 mm										
0270101	3308182701010		16	130	60	84	4xØ8,5	30 / 60	Vrac gencodé	1

Visserie non fournie.

Réglage

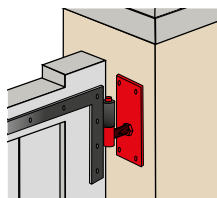
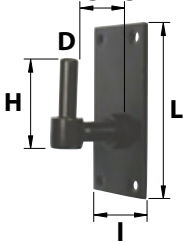

Gond de poteau traversant

Code	Gencod		D	L	D2	H	Type packaging		
L300 mm - Ø14 mm									
0882904	3308188829046		14	300	M12	66	Vrac gencodé		1
685840	3026726858401	Z.BLANC	14	300	M12	66	Vrac gencodé		5
L300 mm - Ø16 mm									
0883004	3308188830042		16	300	M12	70	Vrac gencodé		1
0883003	3308188830035	Z.BLANC	16	300	M12	70	Vrac gencodé		10
L330 mm - Ø16 mm									
685850	3026726858500	Z.BLANC	16	330	M16	85	Vrac gencodé		1
L330 mm - Ø18 mm									
685851	3026726858517	Z.BLANC	18	330	M16	95	Vrac gencodé		1
L330 mm - Ø22 mm									
685852	3026726858524	Z.BLANC	22	330	M18	105	Vrac gencodé		1

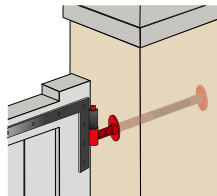
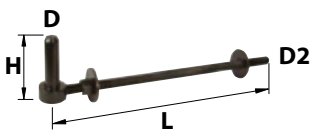

Gond poteau + butée

Code	Gencod		D	L	Type packaging		
685834	3026726858340	Z.BLANC	14	124,5	Vrac gencodé		5
685835	3026726858357	Z.BLANC	14	180	Vrac gencodé		5

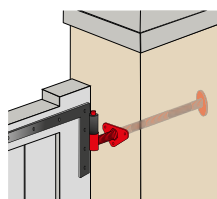
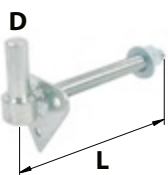



RETROUVEZ NOS PENTURES D16 MM
P. 148-149 - GAMME VOLET

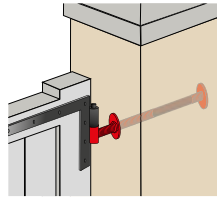
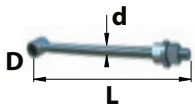

Melle tige filetée

Code	Gencod		D	L	d	Type packaging	
686850	3026726868509	Z.BLANC	14	300	14	Vrac gencodé	1
686851	3026726868516	Z.BLANC	16	300	14	Vrac gencodé	1
686853	3026726868530	Z.BLANC	18	330	16	Vrac gencodé	1
686852	3026726868523	Z.BLANC	22	330	18	Vrac gencodé	1

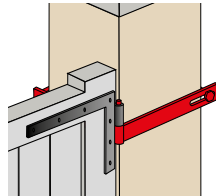
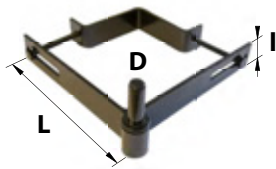

Gond à collier réglable

Code	Gencod		D	L	I	Ep	Type packaging		
Pour poteau de 80 à 100 mm									
M825804	3026728258049	Z.BLANC	14	130	30	5	Vrac gencodé	4	
Pour poteau de 100 à 165 mm									
0270301	3308182703014		14	190	35	5	Vrac gencodé	1	
Pour poteau de 120 à 150 mm									
825916	3026728259169		16	180	30	4	Vrac gencodé	4	
825816	3026728258162	Z.BLANC	16	180	30	4	Vrac gencodé	4	

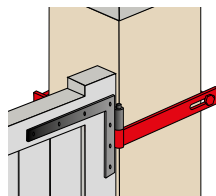
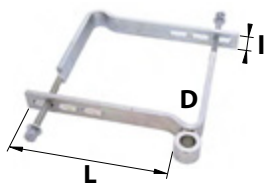

Gond à collier réglable sans axe

Code	Gencod		D	L	I	Ep	Type packaging		
Pour poteau de 140 x 225 mm									
825814	3026728258148	Z.BLANC	14	197	30	8	Vrac gencodé	1	

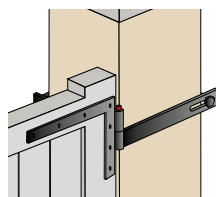
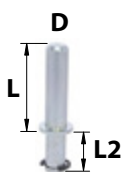

Axe pour gond collier 825814 (x2)

Code	Gencod		D	L	L2	Type packaging	
Avec clip de fixation							
826814	3026728268147	Z.BLANC	14	83,5	50	Vrac gencodé	1
826816	3026728268161	Z.BLANC	16	93,5	60	Vrac gencodé	1
826822	3026728268222	Z.BLANC	22	113,5	80	Vrac gencodé	1

Divers

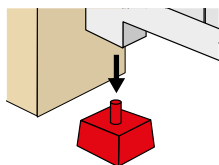
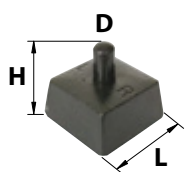

Crapaudine à sceller fonte

Code	Gencod		D	L	H	Type packaging	
0509801	3308185098018		16	77	72	Vrac gencodé	1

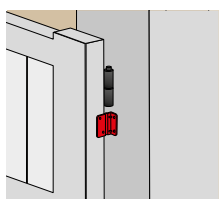
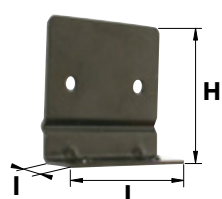

Plaque antisoulèvement (x2)

Code	Gencod		H	L	I	Ep	Nb trous & Øvis	Type packaging	
0952801	3308189528016		47	50	16	1,5	2xØ4,5	Brochable gencodé	1

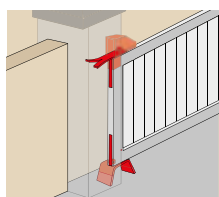
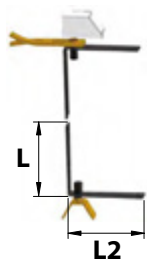

Pivot de portail bois réglable à sceller

Code	Gencod		L	L2	KG	Type packaging	
0957603	3308189576031		200	200	150	Brochable gencodé	1

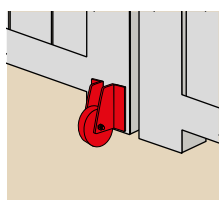
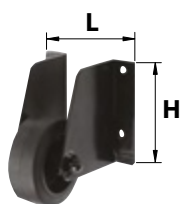

Roulette support de portail

Code	Gencod		L	H	KG	Nb trous & Øvis	Type packaging	
0957701	3308189577014		80	100	65	4xØ5	Brochable gencodé	1

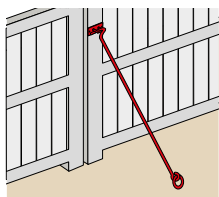

Barre de contrevent à sceller

Code	Gencod		D	L	Type packaging	
0272401	3308182724019		18	1500	Vrac gencodé	1

Composition

Barre de contrevent à sceller + platine gâche.

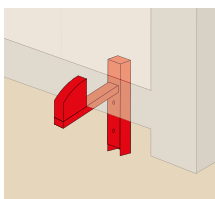

Arrêt de portail automatique à ressort à sceller

Code	Gencod		H	I	Réglage	Type packaging	
0270501	3308182705018		250	25	30 / 70	Vrac gencodé	1
0932503	3308189325035	Z.BLANC	250	25	30 / 70		4
0878803	3308188788039	Z.BLANC	250	25	30 / 70	Vrac gencodé	1

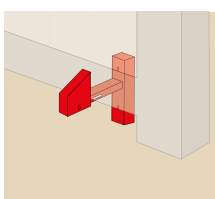
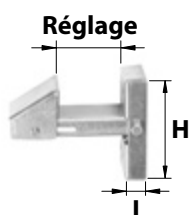

Arrêt de portail automatique mural à ressort à visser

Code	Gencod		H	I	Réglage	Type packaging	
0878703	3308188787032	Z.BLANC	120	23	30 / 70	Vrac gencodé	1

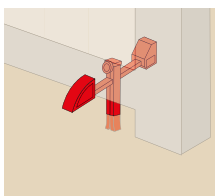
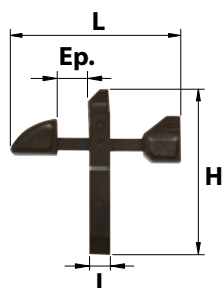

Arrêt de portail à bascule à sceller

Code	Gencod		L	I	H	Ep.	Type packaging	
0886701	3308188867017		250	30	235	45	Vrac gencodé	1
0932401	3308189324014		250	30	235	45		4
0885001	3308188850019		310	30	300	60	Vrac gencodé	1

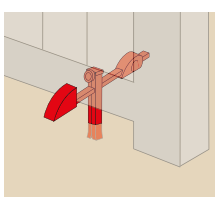
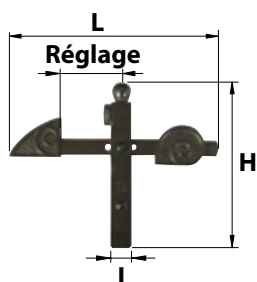

Arrêt de portail à bascule à sceller réglable

Code	Gencod		L	I	H	Réglage	Type packaging	
0270901	3308182709016		310	30	240	45 / 60	Vrac gencodé	5
0942301	3308189423014		310	30	240	45 / 60		4

Sabots à sceller

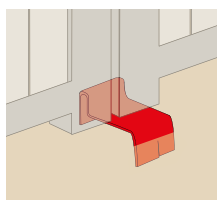
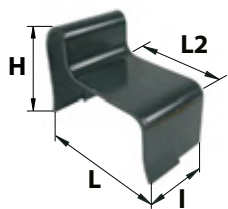

Sabot de portail à sceller

Code	Gencod		L	L2	I	H	Ep	Type packaging	
202293	3479042022931		145	100	60	55	5	Vrac gencodé	1
202294	3479042022948		165	120	90	55	5	Vrac gencodé	1

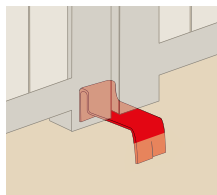
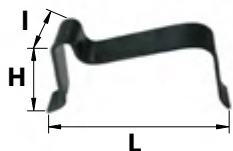

Sabot de portillon à sceller

Code	Gencod		L	L2	I	H	Ep	Type packaging	
824049	3026728240495		140	86,8	30	138	4	Vrac gencodé	1

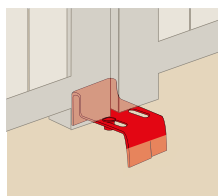
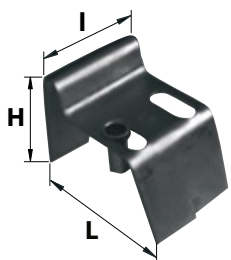

Sabot de portail à sceller + gâche réglable

Code	Gencod		L	I	H	Ep	Type packaging	
0708400	3308187084002		170	100	120	4	Vrac gencodé	1
0892703	3308188927032	Z.BLANC	170	100	120	4	Vrac gencodé	1

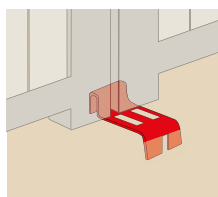
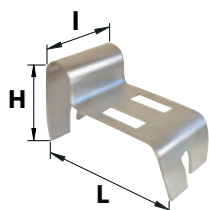

Sabot de portail inox à sceller

Code	Gencod		L	I	H	Ep	Type packaging	
0164400	3308181644004	INOX 316 L	145	80	95	3	Vrac gencodé	1

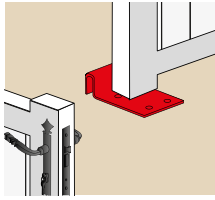
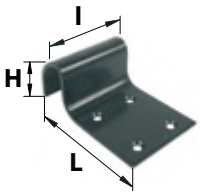

Sabot de portail à visser

Code	Gencod		L	I	H	Ep	Nb trous & Øvis	Type packaging	
502292	3221685022928		145	90	60	5	4xØ8,2	Vrac gencodé	1
502295	3479045022952	Z.BLANC	145	90	60	5	4xØ8,2	Vrac gencodé	1

Visserie non fournie.

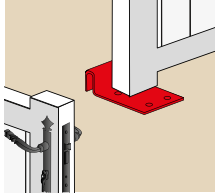
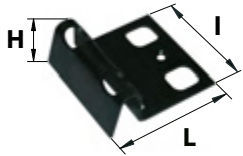

Sabot de portail à visser

Code	Gencod		L	I	H	Ep	Nb trous & Øvis	Type packaging	
502310	3479045023102		106	100	41	3,5	3xØ7	Vrac gencodé	1

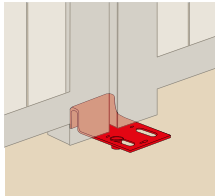
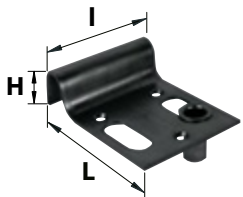

Sabot de portail à visser + gâche réglable

Code	Gencod		L	I	H	Ep	Nb trous & Øvis	Type packaging	
0708500	3308187085009		140	100	40	4	3xØ7	Vrac gencodé	1
0108203	3308181082035	Z.BLANC	140	100	40	4	3xØ7	Vrac gencodé	1
0454501	3308184545018		140	100	40	4	3xØ7		5
0454503	3308184545032	Z.BLANC	140	100	40	4	3xØ7		5

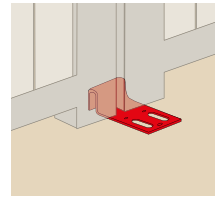
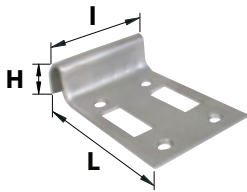

Sabot de portail inox à visser

Code	Gencod		L	I	H	Ep	Nb trous & Øvis	Type packaging	
0166300	3308181663005	INOX 316 L	140	80	33	3	4xØ7,5	Vrac gencodé	1

Visserie non fournie.

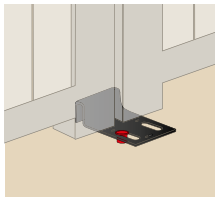
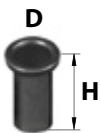

Gâche de sabot de portail

Code	Gencod		D	H	Type packaging	
0262201	3308182622018		18	45	Brochable gencodé	1

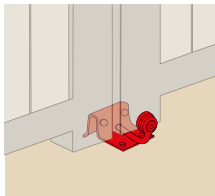

Sabot de portail à basculeur réglable à visser

Code	Gencod		L	I	H	Ep	Type packaging	
0271801	3308182718018		110	80	44	3	Vrac gencodé	1

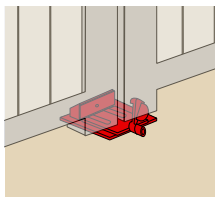
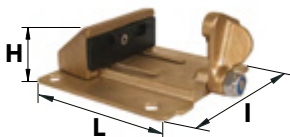

Sabot de portail anticorrosion à basculeur réglable à visser

Code	Gencod		L	I	H	Ep	Type packaging	
0108303	3308181083032	BRUT	118	118	43	3	Vrac gencodé	1

Loquets

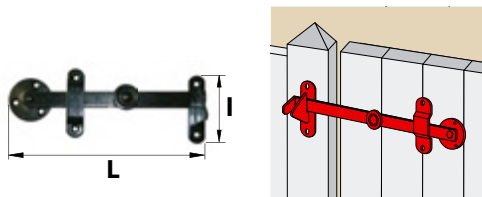

Loquet de sécurité cadenassable

Code	Gencod		L	I	Ep	Nb trous & Øvis	Type packaging	
0272001	3308182720011		200	80	4	3xØ5,3 4xØ6,2	Vrac gencodé	1

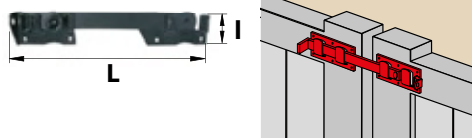

Fléau de portail

Code	Gencod		L	I	Ep	Type packaging	
168440	3026721684401		400	35	5	Vrac gencodé	5

Brides

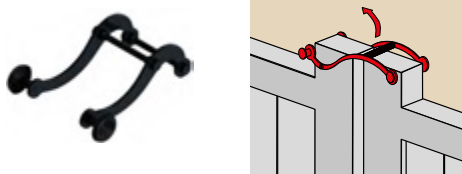

Bride de barrière

Code	Gencod		Type packaging	
870950	3026728709503		Vrac gencodé	1

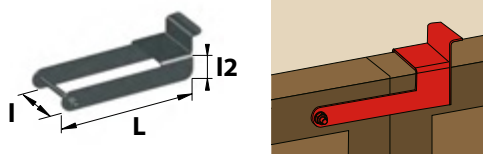

Verrou de barrière à bascule

Code	Gencod		L	I	I2	Type packaging	
133029	3517651330297		250	80	45	Vrac gencodé	1

Verrou

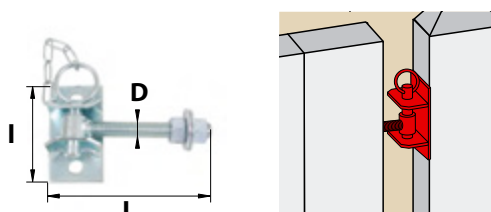

Verrou charnière à goupille

Code	Gencod		D	L	L2	H	Ep.	Type packaging	
738060	3026727380604	ZBLANC	14	140	100	55	3	Vrac gencodé	4



L'EXTÉRIEUR DE L'HABITAT

LE PORTAIL BATTANT ALU & PVC

Pivots

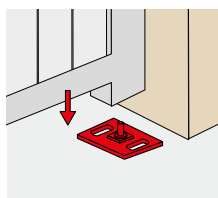
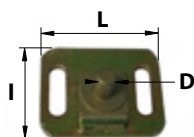
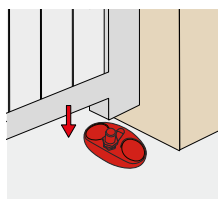
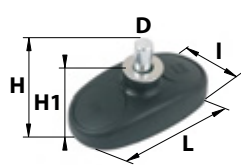
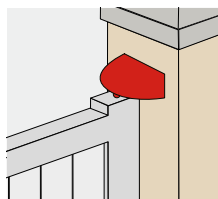
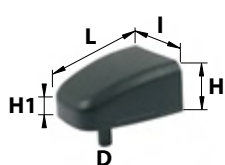
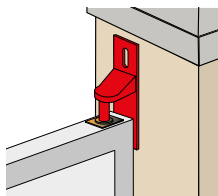
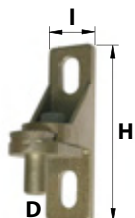
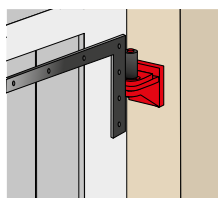
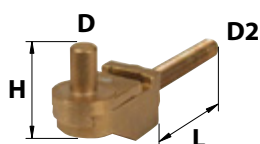

Arrêts

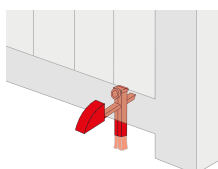
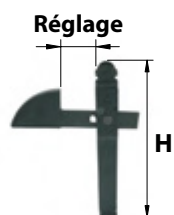
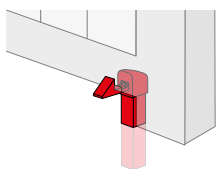

Gond à sceller cupro-aluminium

Code	Gencod		D	L	D2	H	Réglage	Type packaging	
0963500	3308189635004	CUPRO	12	80	M12	50	38 / 60	Vrac gencodé	1

Gond à visser cupro-aluminium

Code	Gencod		D	I	H	Réglage	KG	Type packaging	
0963600	3308189636001	CUPRO	12	28	100	32 / 52	40	Vrac gencodé	1

Gond à visser + cache composite

Code	Gencod		D	L	I	H	H1	Type packaging	
0988500	3308189885003		12	89	100	41	27	Vrac gencodé	1

Crapaudine composite à visser

Code	Gencod		D	L	I	H	H1	Type packaging	
0989200	3308189892001		12	106	57	55	36	Vrac gencodé	1

Crapaudine à visser cupro-aluminium

Code	Gencod		D	L	I	H	Type packaging	
0962600	3308189626002	CUPRO	12	80	65	46	Vrac gencodé	1

Arrêt de portail à sceller

Code	Gencod		H	Tube	Réglage	Type packaging	
0960700	3308189607001		320	40x40	30 / 78	Vrac gencodé	1
0938526	3308189385268		320	40x40	30 / 78		4
0941401	3308189414012		320	40x40	30 / 78		

Arrêt de portail à sceller

Code	Gencod		H	Réglage	Type packaging	
501345	3479045013455		215	30 / 70	Vrac gencodé	1

Arrêts

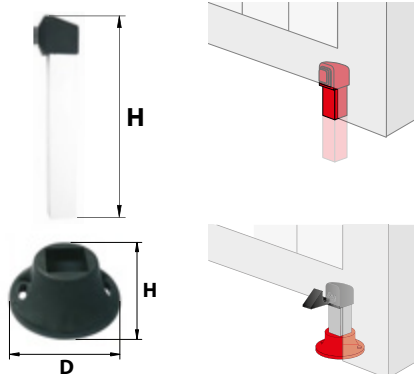

Arrêt pour portail motorisé à sceller

Code	Gencod		H	Tube	Type packaging	
0960900	3308189609005		320	40x40	Vrac gencodé	1

Socle de finition pour arrêt motorisé à visser

Code	Gencod		D	H	Type packaging	
0964400	3308189644006		120	50	Vrac gencodé	1

Sabots

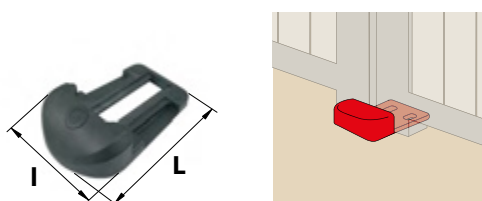

Sabot composite pour portail motorisé

Code	Gencod		L	I	H	Type packaging	
0989000	3308189890007		200	132	50	Vrac gencodé	1

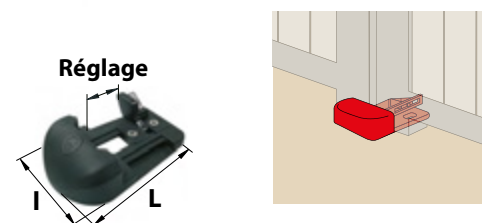

Sabot de portail composite avec basculeur composite

Code	Gencod		L	I	H	Réglage	Type packaging	
0989100	3308189891004		200	132	50	18/80	Vrac gencodé	1

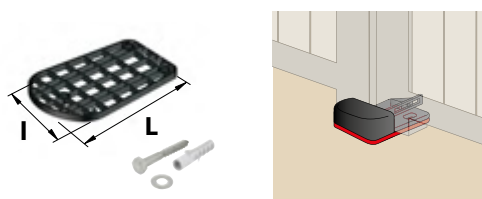

Cale pour sabot de portail composite

Code	Gencod		L	I	H	Type packaging	
0989050	3308189890502		200	132	10	Vrac gencodé	1

Compatible avec références 0989000 et 0989100

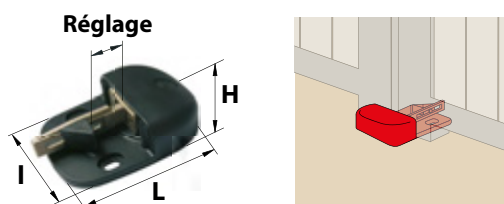

Sabot de portail automatique à visser

Code	Gencod		L	I	H	Réglage	Type packaging	
0964300	3308189643009		160	120	42	20 / 73	Vrac gencodé	1
0941301	3308189413015		160	120	42	20 / 73		4

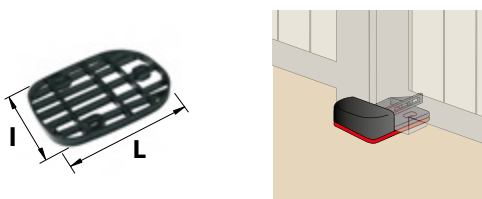

Cale pour sabot de portail composite

Code	Gencod		L	I	H	Type packaging	
0964350	3308189643504		160	120	10	Vrac gencodé	1

Compatible avec références 0964300 et 0941301

Verrous

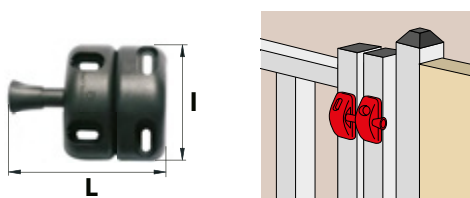

Verrou magnétique anticorrosion

Code	Gencod		L	I	H	Type packaging	
0958400	3308189584005		95	55	14	Brochable gencodé	1

Béquilles

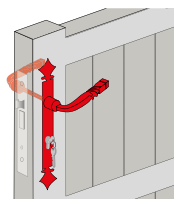
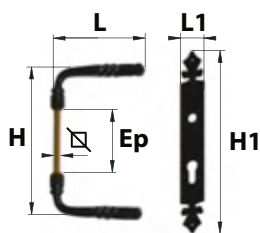

Ensemble béquille et plaque

Code	Gencod		☑	L	H	L1	H1	Ep	Type packaging	
0272101	3308182721018		7	60	115	280	35	30 / 60	Brochable gencodé	1

Serrures

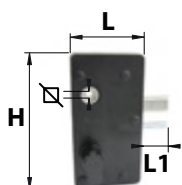

Serrure de portail avec pêne antisouèvement + gâche

Code	Gencod		☑	L	L1	H	Ep	Type packaging		
Sans cylindre										
0894800	3308188948006		7	80	38	158	20	Brochable gencodé	1	
Avec cylindre										
0173300	3308181733005		7	80	38	158	20	Brochable gencodé	1	

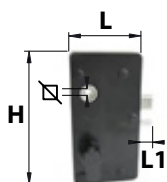

Serrure de portillon avec pêne antisouèvement + gâche

Code	Gencod		☑	L	L1	H	Ep	Type packaging		
Sans cylindre										
0894900	3308188949003		7	80	18	158	20	Brochable gencodé	1	
Avec cylindre										
0173400	3308181734002		7	80	18	158	20	Brochable gencodé	1	

Sécurité piscine

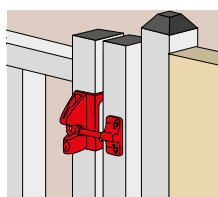

Loquet de portail LOCKKLATCH®

Code	Gencod		Type packaging	
0995600	3308189956000		Brochable gencodé	1

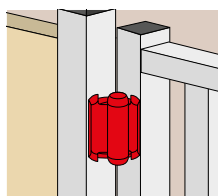
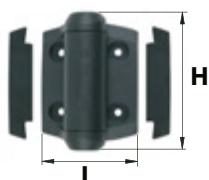

Charnière automatique TRUE-CLOSE® (x2)

Code	Gencod		H	L		Type packaging	
0995700	3308189957007		76	96	25	Brochable gencodé	1

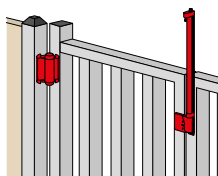

Kit portail sécurité enfant

Code	Gencod			Type packaging	
0995100	3308189951005		25	Brochable gencodé	1



L'EXTÉRIEUR DE L'HABITAT

LE PORTAIL BATTANT ACIER

Ferrures porte extérieure

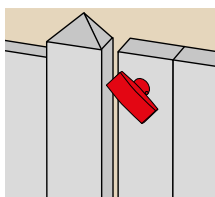
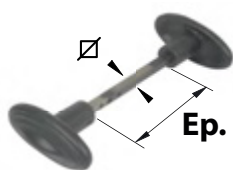

Bouton double - N° 59

Code	Gencod		Ø	Ep	Type packaging	
575050	3479045750503		6	45 / 88	Brochable gencodé	6

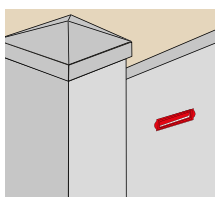

Entrée de boîte aux lettres

Code	Gencod		L	L2	Type packaging	
0277700	3308182777008		320	230	Brochable gencodé	1
0278100	3308182781005	GRIS PATINÉ	320	230	Brochable gencodé	1
0277600	3308182776001	LAITON	320	230	Brochable gencodé	1

Nœuds

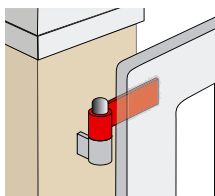
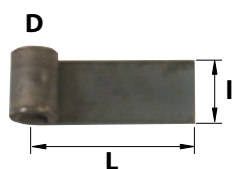

Nœud à souder

Code	Gencod		D	L	I	Ep	Type packaging	
0220700	3308182207000	BRUT	14	100	35	6	Vrac gencodé	10
627005	3221686270052	BRUT	14	100	40	6	Vrac gencodé	1
0220800	3308182208007	BRUT	16	100	40	6	Vrac gencodé	10

Gonds

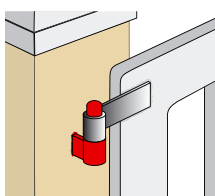
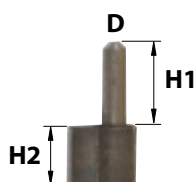

Gond à souder

Code	Gencod		D	H1	H2	Ep	Type packaging	
0221400	3308182214008	BRUT	14	40	40	5	Vrac gencodé	10
0221500	3308182215005	BRUT	16	45	40	6	Vrac gencodé	10

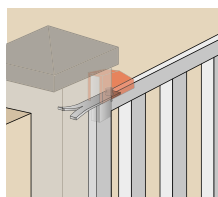
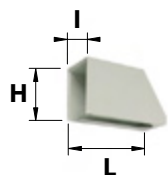

Capot de pivot

Code	Gencod		L	H	I	Type packaging	
0962300	3308189623001		105	59	42	Vrac gencodé	1

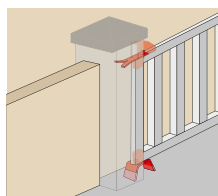

Jeu de pivot à sceller

Code	Gencod		Type packaging	
Pour tube 30 x 30 mm				
0957400	3308189574006	Z.BLANC	Brochable gencodé	1
Pour tube 40 x 40 mm				
0957500	3308189575003	Z.BLANC	Brochable gencodé	1

Verrous

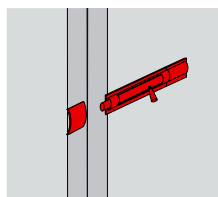
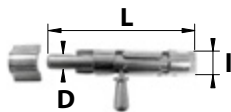

Verrou de box à visser

Code	Gencod		D	L	I	Type packaging	
0361103	3308183611035	Z.BLANC	16	150	26	Vrac gencodé	1

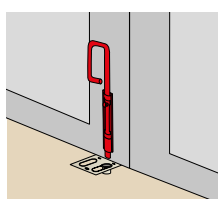
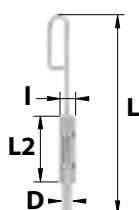

Verrou baïonnette à souder

Code	Gencod		D	L	L2	I	e	Course	Type packaging	
7116003	3221687116038	Z.BLANC	16	300	100	25,5	3	40	Vrac gencodé	1
7116004	3221687116045	Z.BLANC	16	400	100	25,5	3	40	Vrac gencodé	1

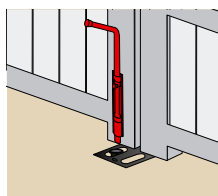
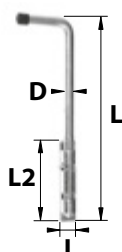

Verrou de pied universel à souder

Code	Gencod		D	L	L2	I	e	Course	Type packaging	
0226003	3308182260036	Z.BLANC	16	300	131	26	3,5	40	Vrac gencodé	1

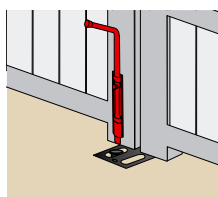

Verrou de pied universel + platine à souder

Code	Gencod		D	L	L2	I	Type packaging	
854117	3026728541172	Z.BLANC	16	170	82	25	Vrac gencodé	5



L'EXTÉRIEUR DE L'HABITAT

LE PORTAIL COULISSANT ACIER

Olives

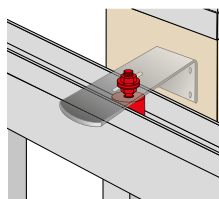

Olive de guidage Ø25

Code	Gencod		D	H	Type packaging	
0227300	3308182273005	Z.BLANC	25	35	Vrac gencodé	10

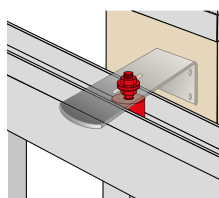

Olive de guidage Ø30

Code	Gencod		D	H	Type packaging	
0444500	3308184445004	Z.BLANC	30	40		20
0227400	3308182274002	Z.BLANC	30	40	Vrac gencodé	10

Guides

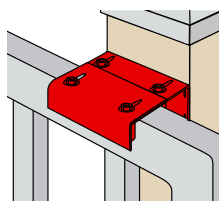
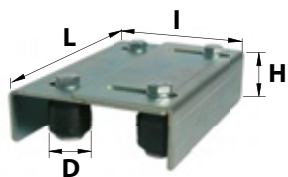

Plaque de guidage - 4 olives

Code	Gencod		D	L	I	H	Ep	Type packaging	
Double réglage									
0926802	3308189268028	Z.BLANC	36	200	145/200	36	3		2
0227700	3308182277003	Z.BLANC	36	200	145/200	36	3	Vrac gencodé	1

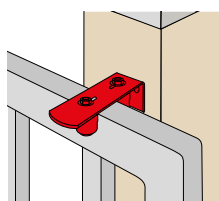
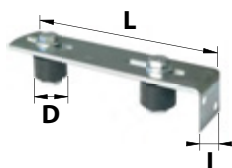

Guide de portail à visser - 2 olives

Code	Gencod		D	L	I	Ep	Type packaging		
Double réglage									
0926702	3308189267021	Z.BLANC	36	250	40	5		8	
0741600	3308187416001	Z.BLANC	36	250	40	5	Vrac gencodé	1	

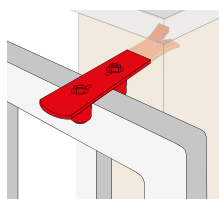

Guide de portail à sceller - 2 olives

Code	Gencod		D	L	I	Ep	Type packaging		
Double réglage									
0741500	3308187415004	Z.BLANC	36	300	40	5	Vrac gencodé	1	

Gâche

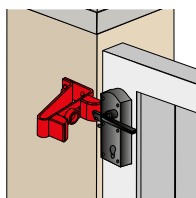
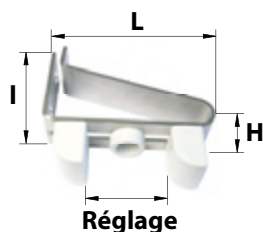

Gâche portail coulissant

Code	Gencod		L	I	H	Ep	Réglage	Type packaging	
0964626	3308189646260		170	90	50	4	36 / 90	Vrac gencodé	1 sachet 1 pièce

Rails & roues U

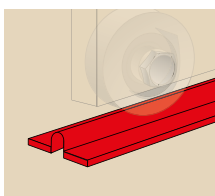
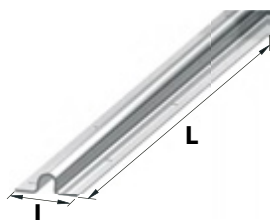

Rail gorge ronde à visser Ø16

Code	Gencod		L	I	Ep	Gorge	Type packaging	
602031	3221686020312	GALVA.	2000	58	3	Ø16	Vrac gencodé	1
0964000	3308189640008	GALVA.	3000	58	3	Ø16	Vrac gencodé	1

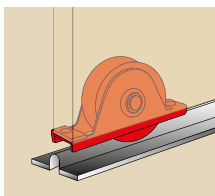
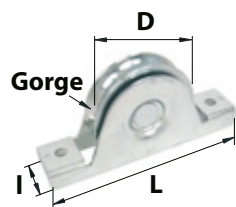

Roue gorge U à encastrer Ø16

Code	Gencod		D	L	I	Ep	Gorge		Type packaging	
0964202	3308189642026	Z.BLANC	90	140	32	3	Ø16	300	Vrac gencodé	1

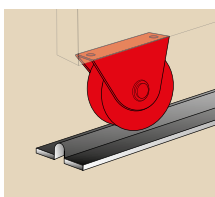

Roue gorge U support extérieur Ø16

Code	Gencod		D	L	I	Ep	Gorge		Type packaging	
0964102	3308189641029	Z.BLANC	80	116	38	3	Ø16	300	Vrac gencodé	1

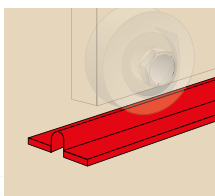
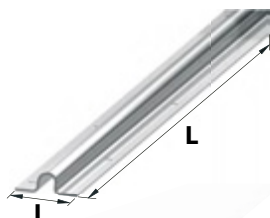

Rail gorge ronde à visser Ø20

Code	Gencod		L	I	Ep	Gorge	Type packaging	
0357100	3308183571001	GALVA.	2000	58	3	Ø20	Vrac gencodé	1

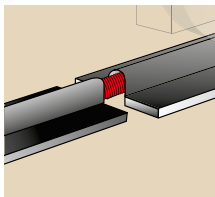
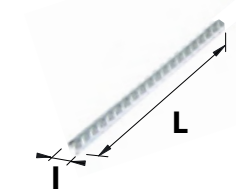

Pièce de jonction pour rails coulissants gorge ronde

Code	Gencod		L	I	Ep	Gorge	Type packaging	
603220	3308186032202	Z.BLANC	120	12	10	Ø20	Brochable gencodé	1

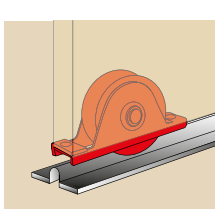
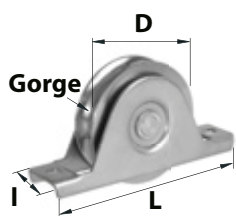

Roue gorge U à encastrer Ø20

Code	Gencod		D	L	I	Gorge		Type packaging	
0693300	3308186933004	Z.BLANC	90	140	32	Ø20	300	Vrac gencodé	1
0693800	3308186938009	Z.BLANC	100	140	32	Ø20	300	Vrac gencodé	1

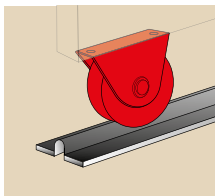
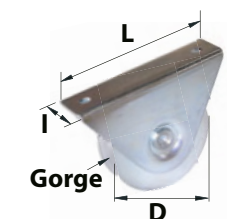

Roue gorge U support extérieur Ø20

Code	Gencod		D	L	I	H	Gorge		Type packaging	
0694000	3308186940002	Z.BLANC	80	116	38	85	Ø20	300	Vrac gencodé	1
0694100	3308186941009	Z.BLANC	100	116	38	110	Ø20	300	Vrac gencodé	1

Rails & roues V

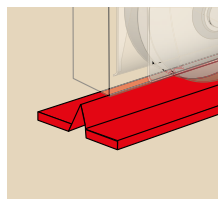

Rail gorge V à visser

Code	Gencod		L	I	H	Ep	Type packaging	
0357000	3308183570004	GALVA	2000	70	23	2	Vrac gencodé	1

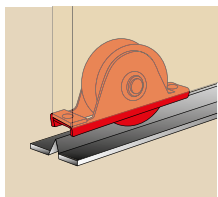
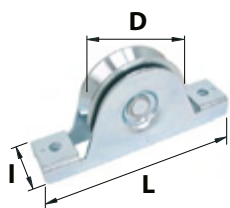

Roue gorge V à encastrer

Code	Gencod		D	L	I	KG	Type packaging	
0226800	3308182268001	Z.BLANC	90	140	32	300	Vrac gencodé	1
0926602	3308189266024	Z.BLANC	90	140	32	300		8

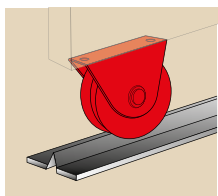
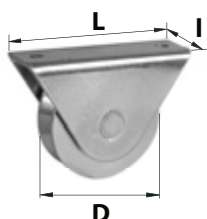

Roue gorge V support extérieur

Code	Gencod		D	L	I	H	KG	Type packaging	
0227100	3308182271001	Z.BLANC	80	116	38	85	300	Vrac gencodé	1
0692900	3308186929007	Z.BLANC	100	116	38	110	300	Vrac gencodé	1
0926502	3308189265027	Z.BLANC	80	116	38	85	300		8

Butées

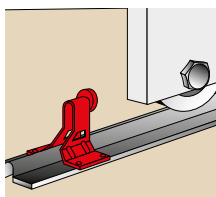
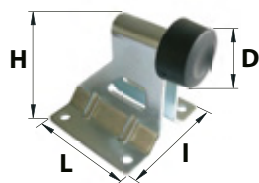

Butée de portail coulissant à visser

Code	Gencod		D	L	I	H	Type packaging	
0867602	3308188676022	Z.BLANC	45	110	110	117	Vrac gencodé	1
0931702	3308189317023	Z.BLANC	45	110	110	117		2

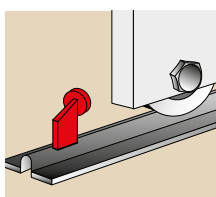
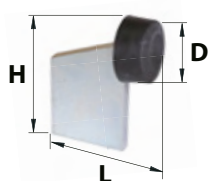

Butée de portail coulissant à souder

Code	Gencod		D	L	H	Type packaging	
0432403	3308184324033	Z.BLANC	10	110	110	Vrac gencodé	1

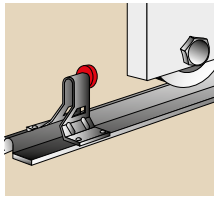

Tampon pour butée de portail à visser et à souder

Code	Gencod		L	I	H	Type packaging	
0997200	3308189972000		40	15	11	Brochable gencodé	1

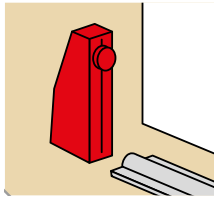
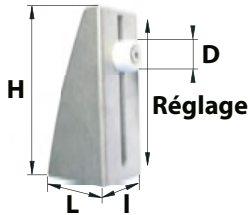

Butée de fin de course portail coulissant + tampon de réception

Code	Gencod		D	L	I	H	Réglage	Type packaging	
0961300	3308189613002	Z.BLANC	30	83	60	172	20 / 152	Vrac gencodé	1

Serrures

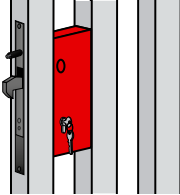
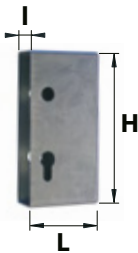

Boîtier de serrure

Code	Gencod		L	I	H	Type packaging	
0228300	3308182283004	BRUT	78	40	171	Vrac gencodé	1

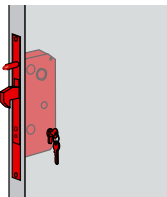
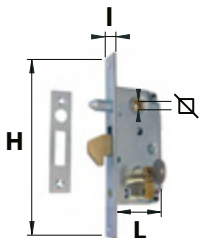

Serrure à crochet avec gâche + cylindre 3 clés

Code	Gencod		∅	L	I	H	Ep	Type packaging	
0227900	3308182279007	Z.BLANC	8	96	25	130	4	Vrac gencodé	1

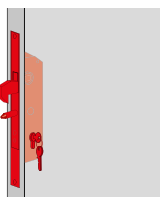
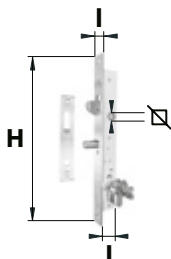

Serrure à larder avec gâche + cylindre

Code	Gencod		∅	L	I	H	Ep	Type packaging	
100058	3221681000586	Z.BLANC	8	26	22	210	2	Vrac gencodé	1

Pour tube carré de 30 mm

Poignées

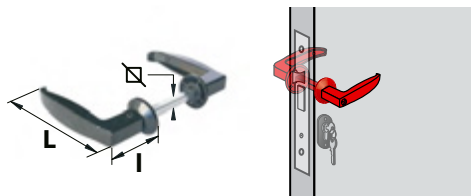

Béquille double

Code	Gencod		∅ D	L	I	Réglage	Type packaging		
Carré 8 mm									
0428006	3308184280063		8	108	44	30 / 85	Vrac gencodé	1 sachet 1 pièce	

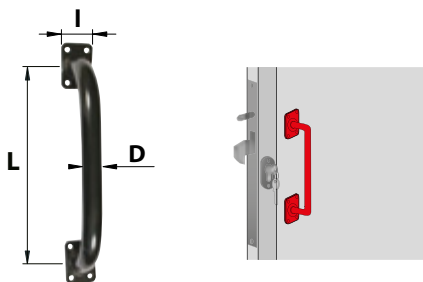

Poignée de tirage

Code	Gencod		D	L	I	Type packaging		
Droite								
0692600	3308186926006		15	230	65	Vrac gencodé	1	
Courbe								
0708100	3308187081001		15	180	65	Vrac gencodé	1	

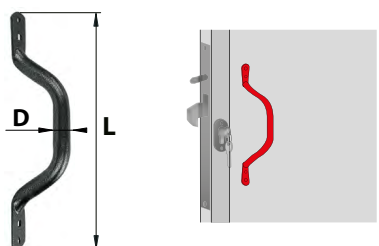
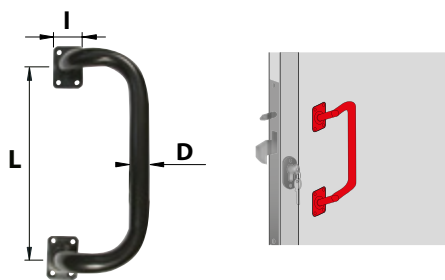

Poignée de tirage droite

Code	Gencod		D	L	Type packaging	
794025	3026727940259	GRANITE	20	280	Vrac gencodé	1
794040	3026727940402	GRANITE	20	400	Vrac gencodé	1
Renforcée						
794035	3026727940358	GRANITE	25	350	Vrac gencodé	1

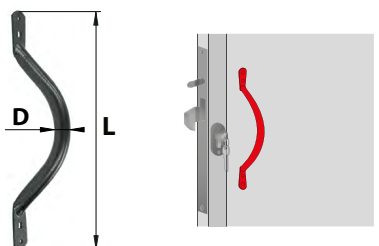

Poignée de tirage demi-rond

Code	Gencod		D	L	Type packaging	
M795001	3026727950012	GRANITE	20	280	Vrac gencodé	1



L'EXTÉRIEUR DE L'HABITAT

LE PORTAIL COULISSANT ALU / PVC

Portail coulissant Alu / PVC

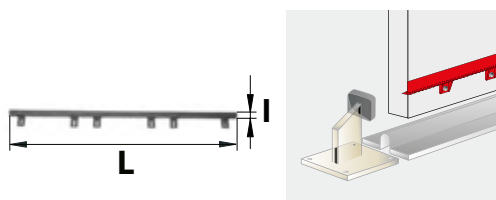

Crémaillère de portail PVC

Code	Gencod		L	I	Ep.	Type packaging	
0741650	3308187416506		1000	28	22	Vrac gencodé	10

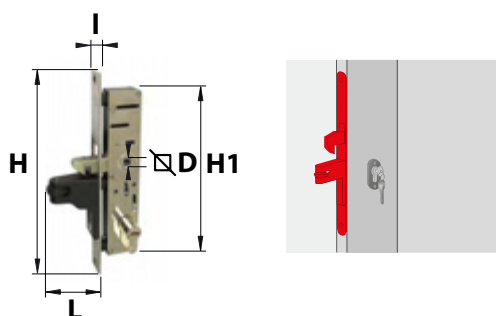

Serrure encastrée à crochet avec galet de recentrage

Code	Gencod		∅D	L	I	H	H1	Ep.	Type packaging	
Carré de 7 axe à 40mm										
0989300	3308189893008		7	51	26	220	182	2,5	Vrac gencodé	1

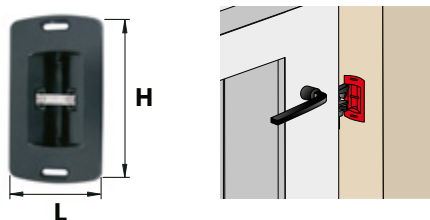

V de réception encastré + gâche

Code	Gencod		L	H	Ep.	Type packaging	
0989400	3308189894005		100	180	47	Vrac gencodé	1

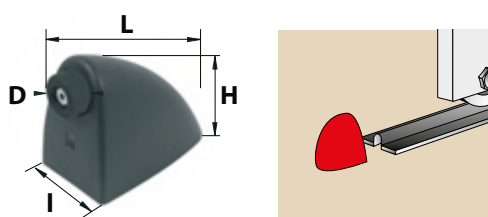

Butée de fin de course capot composite

Code	Gencod		D	L	I	H	Type packaging	
0989500	3308189895002		30	140	70	92	Vrac gencodé	1

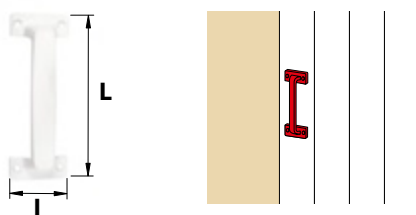

Poignée de porte de garage

Code	Gencod		L	I	Type packaging	
0634900	3308186349003		171	60	Vrac gencodé	1
105055	3221681050550		171	60	Vrac gencodé	1
0635000	3308186350009		171	60	Vrac gencodé	1



L'EXTÉRIEUR DE L'HABITAT

L'AMÉNAGEMENT

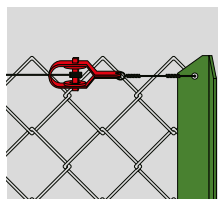
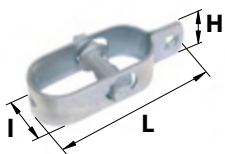

Tendeur de grillage N°2

Code	Gencod		L	I	H	Ep.	Type packaging	
518002	3479045180027	Z.BLANC	95	42	20	2	Vrac gencodé	100
518221	3363595182214		95	42	20	2	Vrac gencodé	100
518321	3479045183219		95	42	20	2	Vrac gencodé	100

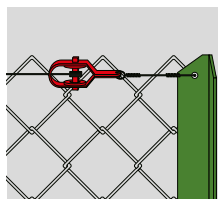

Tendeur de grillage N°3

Code	Gencod		L	I	H	Ep.	Type packaging	
518003	3479045180034	Z.BLANC	100	49	25	2	Vrac gencodé	100
518231	3479045182311		100	49	25	2	Vrac gencodé	100
518331	3479045183318		100	49	25	2	Vrac gencodé	100

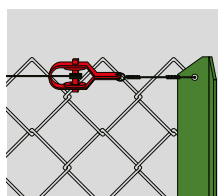

Tendeur de grillage N°4

Code	Gencod		L	I	H	Ep.	Type packaging	
518004	3479045180041	Z.BLANC	122	63	30	2	Vrac gencodé	50
518371	3479045183714		122	63	30	2	Vrac gencodé	50

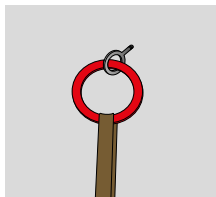
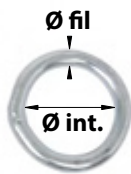

Anneau

Code	Gencod		Ø fil	Ø int.	Type packaging	
501141	3479045011413	Z.BLANC	8	45	Vrac gencodé	10
501151	3479045011512	Z.BLANC	10	50	Vrac gencodé	10
501161	3479045011611	Z.BLANC	12	60	Vrac gencodé	10

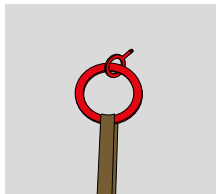
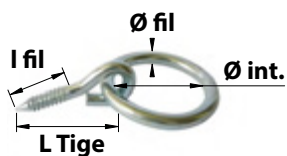

Anneau à visser

Code	Gencod		Ø fil	L. Tige	Ø int.	l fil.	Type packaging	
501051	3479045010515	Z.BLANC	8	73	50	30	Vrac gencodé	10
501061	3479045010614	Z.BLANC	10	85	50	37	Vrac gencodé	5
605012	3026726050126	Z.BLANC	12	97,5	60	45	Vrac gencodé	10

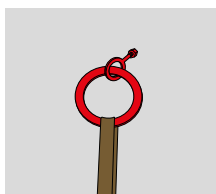
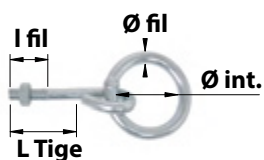

Anneau à boulonner avec écrou

Code	Gencod		Ø fil	L. Tige	Ø int.	l fil.	Type packaging	
501101	3479045011017	Z.BLANC	8	40	50	20	Vrac gencodé	5
501111	3479045011116	Z.BLANC	10	50	50	30	Vrac gencodé	5
501129	3479045011291	Z.BLANC	10	90	50	40	Vrac gencodé	5
501121	3479045011215	Z.BLANC	12	85	60	40	Vrac gencodé	5
606030	3026726060309	Z.BLANC	12	100	60	40	Vrac gencodé	10
606032	3026726060323	Z.BLANC	12	130	60	40	Vrac gencodé	10

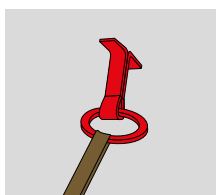
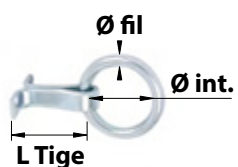

Anneau pour dalle à sceller

Code	Gencod		Ø fil	L. Tige	Ø int.	Type packaging	
609013	3026726090139	Z.BLANC	10	57,5	45	Vrac gencodé	10

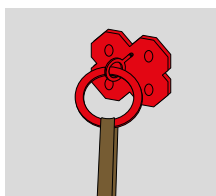
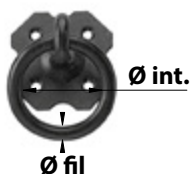

Anneau pour dalle sur platine

Code	Gencod		Ø fil	Ø int.	Type packaging	
610985	3026726109855		10	50	Vrac gencodé	10

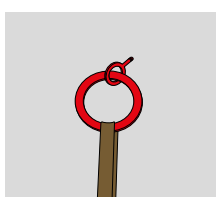
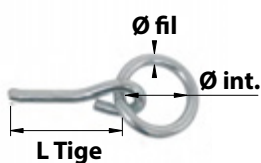

Anneau à sceller

Code	Gencod		Ø fil	L. Tige	Ø int.	Type packaging	
501081	3479045010812	Z.BLANC	10	70	50	Vrac gencodé	5
501091	3479045010911	Z.BLANC	12	70	60	Vrac gencodé	5

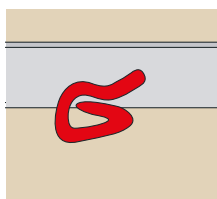
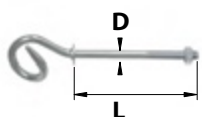

Crochet de gymnase à boulonner

Code	Gencod		D	L	Type packaging	
673012	3026726730127	Z.BLANC	12	70	Vrac gencodé	4
9503501	3479045035013	Z.BLANC	12	158	Vrac gencodé	1
503511	3479045035112	Z.BLANC	14	180	Vrac gencodé	1

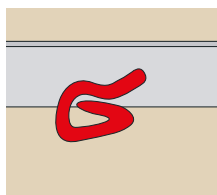
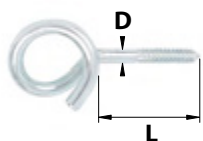

Crochet de gymnase à visser

Code	Gencod		D	L	Type packaging	
674012	3026726740126	Z.BLANC	12	160	Vrac gencodé	4

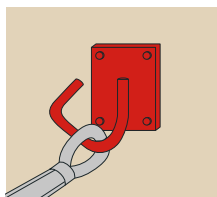
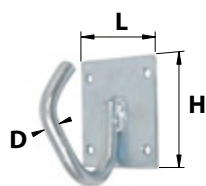

Crochet de hamac sur platine

Code	Gencod		D	H	L	Type packaging	
000302	3479040003024	Z.BLANC	10	80	50	Vrac gencodé	10
617009	3026726170091	ROUGE	10	80	50	Vrac gencodé	10
617005	3026726170053	BLANC	10	80	50	Vrac gencodé	10
617006	3026726170060	BLEU	10	80	50	Vrac gencodé	10
617007	3026726170077	JAUNE	10	80	50	Vrac gencodé	10
617008	3026726170084	VERT	10	80	50	Vrac gencodé	10
617010	3026726170107	NOIR	10	80	50	Vrac gencodé	10

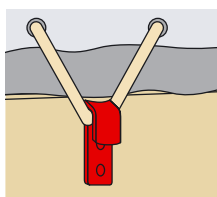
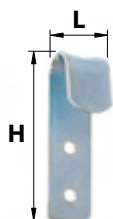

Crochet de bâchage à visser

Code	Gencod		H	L	Type packaging	
0900602	3308189006026	Z.BLANC	70	20	Brochable gencodé	1
6160070	3221686160070	Z.BLANC	70	20	Vrac gencodé	10

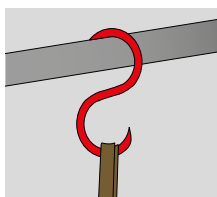
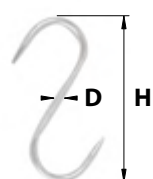

Esse de boucher inox

Code	Gencod		D	H	Type packaging	
671008	3026726710082	INOX 304 L	4	80	Vrac gencodé	10
671012	3026726710129	INOX 304 L	5	120	Vrac gencodé	10
671016	3026726710167	INOX 304 L	6	160	Vrac gencodé	10

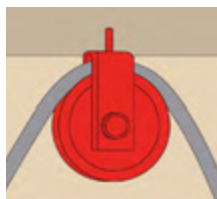

Poulie à crochet nylon

Code	Gencod		D	Type packaging	
516380	3479045163808	<input type="text"/>	30	Vrac gencodé	5
516390	3479045163907	<input type="text"/>	40	Vrac gencodé	5
516400	3479045164003	<input type="text"/>	50	Vrac gencodé	5

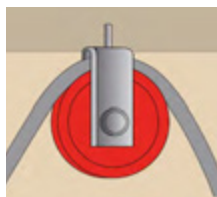
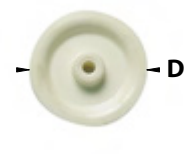

Poulie nylon

Code	Gencod		D	Type packaging	
516340	3479045163402	<input type="text"/>	30	Vrac gencodé	5
516350	3479045163501	<input type="text"/>	40	Vrac gencodé	5

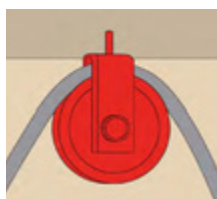

Poulie à crochet fonte

Code	Gencod		D	Type packaging	
529781	3479045297817	Fonte	40	Vrac gencodé	5
529791	3479045297916	Fonte	50	Vrac gencodé	10
529801	3479045298012	Fonte	60	Vrac gencodé	10

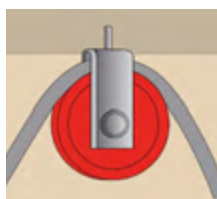

Poulie fonte

Code	Gencod		D	Type packaging	
529661	3479045296612	Fonte	40	Vrac gencodé	5
529671	3479045296711	Fonte	50	Vrac gencodé	5
529681	3479045296810	Fonte	60	Vrac gencodé	10

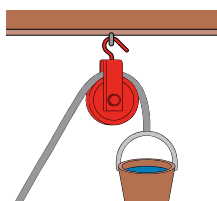

Poulie de puits

Code	Gencod		D	Ep. gorge	Type packaging	
529482	3479045294823	Fonte	160	22	Vrac gencodé	1
816020	3026728160205		180	23	Vrac gencodé	1

Grilles aération

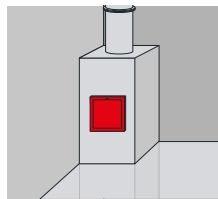
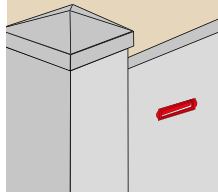
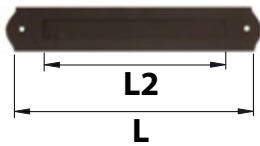
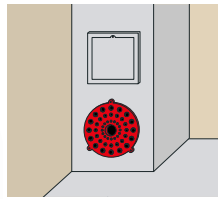

Grille d'aération ronde

Code	Gencod		D	Type packaging	
507461	3479045074616	Fonte	110	Vrac gencodé	1
507471	3479045074715	Fonte	130	Vrac gencodé	1
507481	3479045074814	Fonte	160	Vrac gencodé	1

Entrée de boîte aux lettres

Code	Gencod		L	L2	Type packaging	
0277700	3308182777008		320	230	Brochable gencodé	1
0278100	3308182781005	GRIS PATINE	320	230	Brochable gencodé	1
0277600	3308182776001	LAITON	320	230	Brochable gencodé	1

Trappe de ramonage

Code	Gencod		L	H	Type packaging	
529261	3479045292614	Fonte	190	200	Vrac gencodé	1
529271	3479045292713	Fonte	210	230	Vrac gencodé	1

Accessoires de chantier

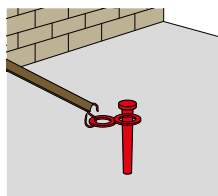
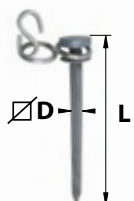
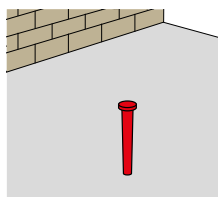
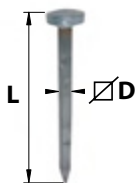
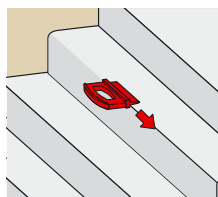
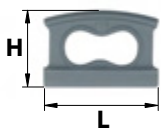
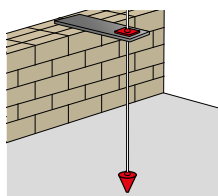
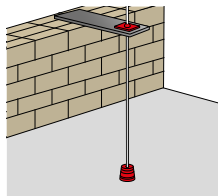

Plomb de maçon avec plaque

Code	Gencod		L	Type packaging	
N° 6					
529077	3479045290771	Fonte	49	Vrac gencodé	1
N° 10					
529079	3479045290795	Fonte	58	Vrac gencodé	1

Plomb mécanicien avec plaque

Code	Gencod		D	Type packaging	
529148	3479045291488	Fonte	40	Vrac gencodé	1

Fer à joint fonte

Code	Gencod		H	L	I	Type packaging	
506051	3479045060510	Fonte	68	90	26	Vrac gencodé	5

Piquet de tiers tête ronde

Code	Gencod		D	L	Type packaging	
789035	3026727890356	BRUT	18	300	Vrac gencodé	1
789040	3026727890400	BRUT	18	400	Vrac gencodé	1

Piquet de tiers tête tournante

Code	Gencod		D	L	Type packaging	
790040	3026727900406	BRUT	18	400	Vrac gencodé	1



GAMME HYSOS



hysos

Nos solutions barrière

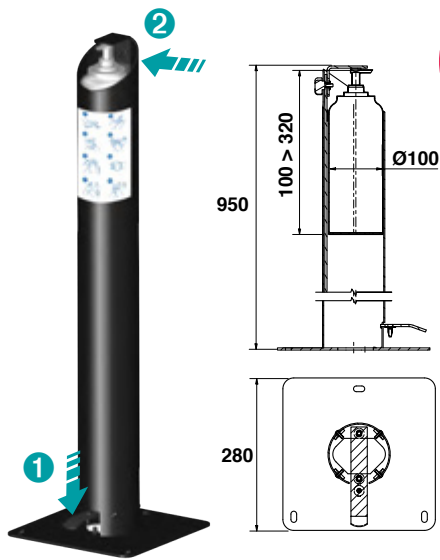

Support à pédale pour gel hydroalcoolique

Code	Gencod	Type packaging
500017*	3026725000177	Vrac gencodé 4

* Flacon de gel non fourni.

Atouts produit

- Distributeur mécanique à commande au pied 1.
- Pas de contact direct avec les surfaces contaminées.
- Remplacement du flacon rapide 2 par le dessus.
- Adaptable à tous flacons (Ø max. du flacon < à 100 mm et H : 100 à 320 mm max.).
- Mise en place rapide : ne nécessite aucune alimentation électrique et ne contient aucun élément électronique.
- Fixation au sol possible avec trous oblongs pour éviter tout vol.
- Action manuelle possible pour les Personnes à Mobilité Réduite par la partie supérieure du distributeur.
- Autocollant sanitaire fourni.
- Matière : Acier laqué noir.
- Dimensions : 950 x Ø100 mm.



Support pour gel hydroalcoolique*

Code	Gencod	Type packaging
500014	3026725000146	Vrac gencodé 4

* Flacon de gel non fourni.

Atouts produit

- Adaptable à toute taille de flacon.
- Livré monté avec 6 liens de fixation plastiques pour le flacon.
- Fiche sanitaire + adhésifs fournis.
- Matière : Acier laqué noir.
- Dimensions : 1100 x 280 x 280 mm.



Support mural pour gel hydroalcoolique*

Code	Gencod	Type packaging
500015	3026725000153	Vrac gencodé 4

* Flacon de gel non fourni.

Atouts produit

- Bords du socle de réception du flacon arrondis pour éviter toute blessure.
- Fixation au mur grâce à 2 trous oblongs.
- Remplacement du flacon rapide.
- Livré monté avec 3 liens de fixation plastiques pour le flacon.
- Fiche sanitaire + adhésifs fournis.
- Matière : Acier laqué noir.
- Dimensions : 95 x 90 x 100 mm.

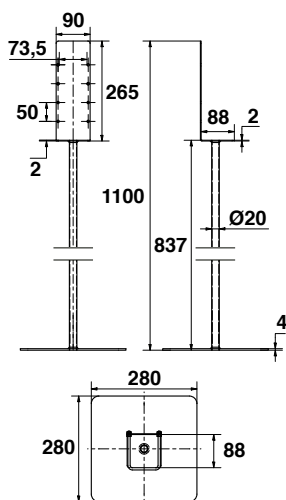

Distributeur sans contact de gel hydroalcoolique

Code	Gencod	Type packaging
500029	3026725000290	Vrac gencodé 4

* Gel non fourni.
** Piles non fournies.

Atouts produit

- **Capteur infrarouge qui détecte les mouvements :**
- **Hygiénique :** évite le contact direct avec les surfaces contaminées.
- **Economique :** délivre la juste quantité de gel.
- **Lampe UV bactéricide :** améliore l'efficacité de la désinfection.
- **Flacon réutilisable*** avec un système de remplissage pratique.
- **Mise en place rapide.**
- Livré monté.
- Contenance 1L : permet jusqu'à **1 250 utilisations.**
- Fonctionne avec 4 piles 1,5V type C**.
- Durée de vie des piles : **30 000 utilisations**
- Autocollant sanitaire fourni.
- **Matière du support :** Acier laqué noir.
- **Dimensions :** 1100 x 280 x 100 mm.

Accessoires



Bloc distributeur de gel savon ou mousse sans contact

Code	Gencod	Type packaging
500030	3026725000306	Vrac gencodé 4

* Gel non fourni.
** Piles non fournies.

Atouts produit

- **Capteur infrarouge qui détecte les mouvements :**
- **Hygiénique :** évite le contact direct avec les surfaces contaminées.
- **Economique :** délivre la juste quantité de gel hydroalcoolique ou de savon.
- **Lampe UV bactéricide :** améliore l'efficacité de la désinfection.
- **Flacon réutilisable*** avec un système de remplissage pratique.
- Contenance 1L : permet jusqu'à **1 250 utilisations.**
- Fonctionne avec 4 piles 1,5V type C**.
- Durée de vie des piles : **30 000 utilisations.**
- Autocollant sanitaire fourni.
- **Dimensions :** 130 x 127 x 270 mm

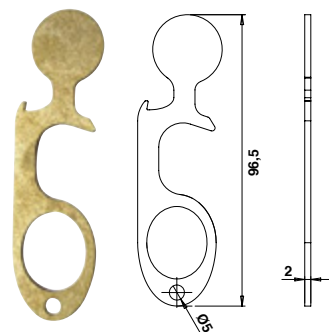
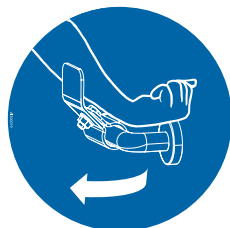
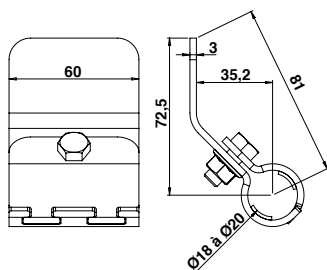
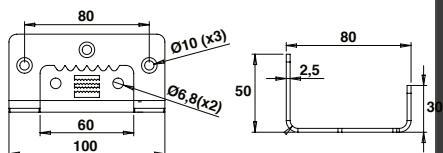
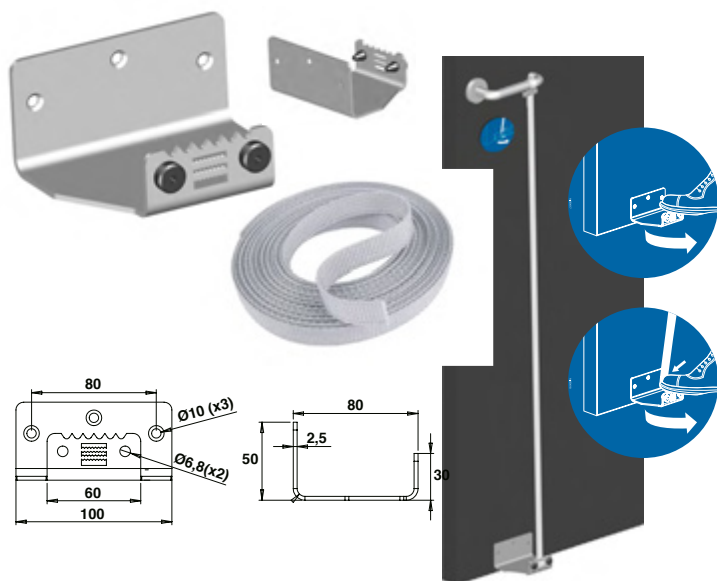

Cu⁺ Laiton CU+ Antimicrobien

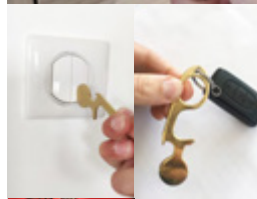
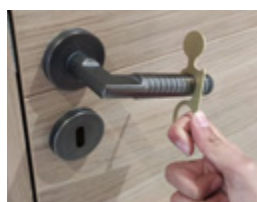

Ouvre-porte pour pied Double action - Lot de 2

Code	Gencod	Type packaging
500016	3026725000160	INOX 304 Vrac gencodé 4

Atouts produit

- Tirage de porte avec le pied sans toucher la poignée.
- **Double action :**
 - Porte sans poignée : poser le pied sur la surface dentelée et tirer vers l'arrière.
 - Portes avec poignée : poser le pied sur la surface dentelée et sur la sangle. Celle-ci actionne la poignée. Tirer vers l'arrière.
- **Pour toutes les portes battantes.**
- Compatible avec les ferme-portes.
- **Tampons amortisseurs** empêchant le marquage du mur.
- Facile à monter.
- Livré avec sangle, autocollants pour porte et notice de montage.
- **Livré avec visserie :**
 - 1 vis relieuse inox pour portes standard
 - 3 vis bois TF inox 4x25 mm.
- **Matière :** Inox brut- Ép : 2,5 mm

Ouvre-porte mains libres

Code	Gencod	Type packaging
500019	3026725000191	Vrac gencodé 4

Atouts produit

- **Ouverture de porte avec l'avant bras** limitant la transmission de germes, microbes et virus.
- **Idéal pour tous les lieux publics :** commerces, usines, collectivités, hôpitaux...
- Pour toutes les portes battantes **avec poignée Ø18 à 20 mm.**
- **Caoutchouc à l'intérieur du mécanisme** pour protéger la poignée et le maintenir en position.
- Facile à monter.
- Livré avec visserie, autocollant pour porte et notice de montage.
- **Matière :** Aluminium laqué noir.

Ouvre-porte sans contact

Code	Gencod	Type packaging
500118	3026725001181	LAITON CU+ Vrac gencodé 10

Atouts produit

- **Objet indispensable dans la non transmission des microbes** lors de vos sorties :
 - Permet d'**ouvrir les portes sans les toucher** grâce à son crochet de tirage.
 - **Évite la manipulation** des boutons d'ascenseur, écrans tactiles, bouton d'ouverture de porte du métro, terminal de carte de crédit...
 - **Ouvre-bouteilles et jeton de chariot** de course intégrés.
- **S'accroche facilement à tous les porte-clés.**
- **Finition Laiton CU+ pour une action antimicrobienne*** qui élimine 99,9% des bactéries en 2 heures.
Plus d'informations sur <https://copperalliance.fr/>
- **Nettoyage facile.**

*Ne se substitue pas aux règles d'hygiène.

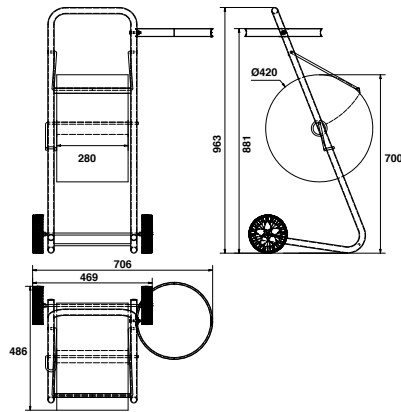
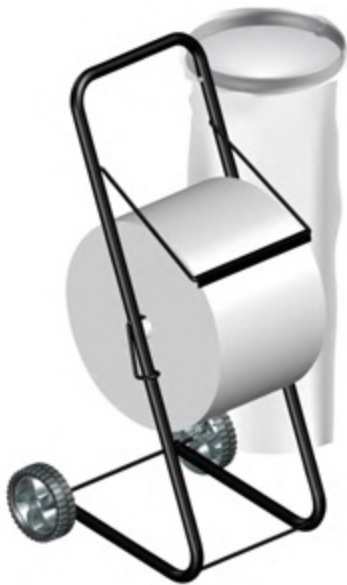

Dérouleur essuie-mains sur pied et porte sac poubelle intégré

Code	Gencod		Type packaging	
500025	3026725000252		Vrac gencodé	1

Atouts produit

- **2 en 1 :**
Dérouleur pour essuie-mains industriel sur pied : Facile à utiliser grâce à la lame de découpe intégrée. Compatible avec bobine de diamètre 420 mm.
Support pour sac poubelle sur le côté du dérouleur : Doté d'un élastique maintenant le sac en place et facilite ainsi son changement. Compatible avec des sacs de 110 L.
- **Support facilement manipulable grâce à ses 2 roues.**
- **Vendu nu sans bobine ni sac poubelle.**
- **Matière :** acier laqué noir.

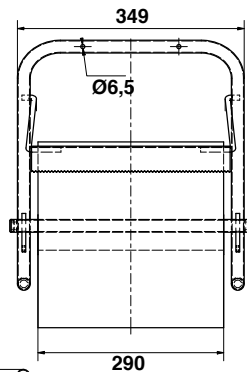

Dérouleur essuie-mains mural ou à poser avec lame de découpe

Code	Gencod		Type packaging	
500023	3026725000238		Vrac gencodé	1

Atouts produit

- **Dérouleur pour essuie-mains industriel avec lame de découpe intégrée.**
- A accrocher au mur ou à poser sur comptoir.
- Compatible avec bobine de diamètre 290 mm et largeur maxi 290 mm.
- Vendu nu, sans bobine ni visserie.
- **Matière :** Acier laqué blanc.

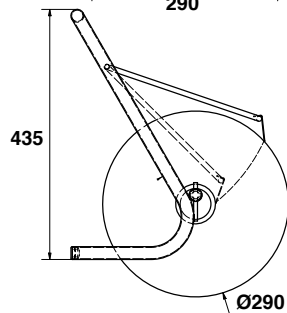



Dérouleur essuie-mains mural

Code	Gencod		Type packaging	
500022	3026725000221		Vrac gencodé	5

Atouts produit

- **Dérouleur mural pour essuie-mains industriel.**
- Compatible avec bobine de Ø 340 mm et largeur 260 mm maximum.
- Vendu nu, sans bobine, ni visserie.
- **Matière :** Acier laqué gris.

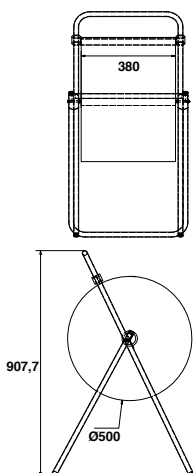
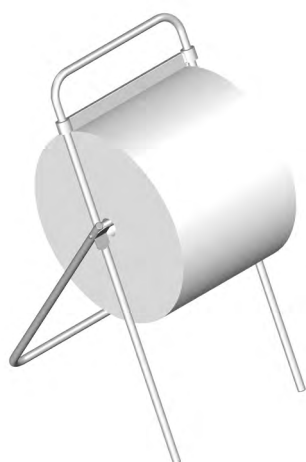
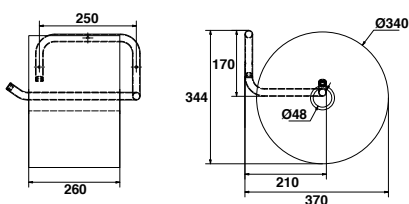

Dérouleur essuie-mains sur pied

Code	Gencod		Type packaging	
500024	3026725000245		Vrac gencodé	1

Atouts produit

- **Dérouleur pour essuie-mains industriel sur pied.**
- Facile à utiliser grâce à la lame de découpe intégrée.
- Compatible avec bobine de diamètre 500 mm et largeur 380 mm maximum.
- Vendu nu, sans bobine.
- **Matière :** Acier laqué blanc.

INDEX NUMÉRIQUE

000302	316	011540	98	0170700	213	0237400	69	0246504	171	0272001	234	0357000	308
000317	106	011541	98	0170800	214	0237701	158	0246702	230	0272001	296	0357100	307
002581	89	011542	98	0170900	106	0237801	290	0246902	230	0272101	300	0357804	105
002582	89	011543	98	0170900	214	0237901	158	0247403	192	0272401	292	0357804	171
002702	91	0115625	98	0171000	213	0238001	164	0247403	235	0273201	169	0359300	231
002703	91	0133029	234	0173300	300	0238003	164	0247503	192	0273901	161	0361103	226
006917	108	0144175	170	0173400	300	0238801	156	0247503	235	0274001	161	0361103	304
007121	93	0161900	210	0174403	194	0238901	156	0247902	17	0277600	302	0362501	173
007122	93	0162000	210	0174403	238	0240001	156	0248002	17	0277600	318	0364500	258
007131	93	0162100	210	0183103	90	0240802	153	0248102	17	0277700	302	0364600	258
007132	93	0162200	210	0183106	90	0240802	222	0248601	165	0277700	318	0364900	258
007221	93	0162700	211	0183403	90	0240902	153	0249001	164	0278100	302	0365300	258
007222	93	0162800	211	0183406	90	0240902	222	0249301	164	0278100	318	0366203	18
007231	93	0163400	212	0185503	90	0241002	153	0249501	166	0280403	156	0366703	18
007271	93	0163902	226	0185506	90	0241002	222	0249703	218	0280503	156	0382603	196
007272	93	0163911	226	0191100	17	0241102	153	0251302	17	0280903	156	0382703	196
007281	93	0164002	226	0198703	166	0241102	222	0251702	17	0281201	164	0382801	150
007282	93	0164011	226	0198704	166	0241202	153	0251902	17	0281203	164	0387201	158
007321	93	0164102	226	020205	90	0241202	222	0254201	152	0281301	164	0387203	158
007322	93	0164111	226	020207	90	0241301	157	0254601	152	0281303	164	0389701	150
007381	93	0164202	226	020208	90	0241401	157	0256700	16	0288002	173	0390000	257
008331	102	0164211	226	021202	88	0241603	157	0256700	110	0288101	160	0408403	177
008332	102	0164301	226	021203	88	0241803	157	0256800	16	0288201	160	0408404	177
0095702	153	0164302	226	021206	88	0241901	161	0256800	110	0304202	17	0409103	192
0095702	222	0164400	214	021208	88	0242201	159	0257200	16	0312906	194	0409103	236
0095704	153	0164400	294	021210	88	0242502	227	0257200	110	0312906	238	0409203	192
0095704	222	0164602	227	0214600	181	0242702	227	0257301	159	0312926	194	0409203	235
0096401	159	0164611	227	0214800	181	0242802	227	0258201	105	0312926	238	0410726	69
0100101	25	0164702	227	021504	88	0242902	227	0258201	171	0318103	192	041119	67
0107905	290	0164711	227	021506	88	0243503	232	0258202	105	0318103	236	0411300	69
0108005	290	0164802	227	021507	88	0244101	176	0258202	171	0318104	192	041146	66
0108203	295	0164811	227	021509	88	0244301	176	0258402	226	0318104	236	041161	67
0108303	295	0164902	227	0215300	181	0245402	172	0258702	226	0318304	194	041273	66
0108506	233	0165002	227	0218100	69	0245402	224	0258802	226	0318304	238	041321	66
0108600	183	0165011	227	0220700	302	0245502	172	0258902	226	0330302	153	041345	66
0108700	183	0165602	233	0220800	302	0245502	224	0259202	226	0330302	222	041361	66
0108800	183	0166300	214	0221400	302	0245602	172	0259801	166	0330902	98	041372	66
0108900	183	0166300	295	0221500	302	0245602	224	0260000	183	0331102	98	0417303	189
0109405	151	0166402	228	0221904	161	0245702	172	0260703	96	0331202	98	0417403	189
0109503	163	0166503	232	0222901	164	0245702	224	0260801	161	0331302	98	0417501	164
0109603	16	0166803	232	0222903	164	0245802	172	0261501	178	0331402	98	0417501	190
0109603	110	0166901	230	0226003	232	0245802	224	0262101	174	0331502	98	0417902	230
0109703	16	0166902	230	0226003	304	0245902	172	0262201	295	0331602	98	0418000	163
0109703	110	0167002	230	0226101	233	0245902	224	0265401	148	0331702	98	0418100	162
0109803	16	0167011	230	0226103	233	0246002	172	0265501	149	0331902	98	0418301	157
0109803	110	0167102	230	0226800	308	0246002	224	0269401	176	0332102	98	0418404	161
0109903	16	0167111	230	0227100	308	0246102	172	0269601	178	0337103	193	0418501	190
0109903	110	0167202	230	0227300	306	0246102	224	0270001	290	0337103	237	0418601	158
0110003	16	0167211	230	0227400	306	0246302	169	0270101	290	0337504	193	0418702	190
0110003	110	0167302	230	0227700	306	0246402	169	0270301	291	0337504	237	0418801	190
011206	89	0167311	230	0227900	309	0246503	106	0270501	293	0337706	194	0419401	189
011208	89	0167402	230	0228300	309	0246503	171	0270901	293	0337706	238	042101	67
011494	100	0170600	213	0236400	20	0246504	106	0271801	295	0350306	158	0422402	98

INDEX NUMÉRIQUE

0422702	98	0491103	173	0511500	254	0527900	247	0541100	247	0552400	248	0573700	249
0423000	158	0491103	224	0511600	254	0528000	247	0542100	247	0552500	248	0574100	249
0423900	212	0491104	173	0511800	254	0528100	247	0542200	247	0552800	248	0575500	249
0425901	164	0491303	106	0512200	254	0528200	247	0542300	247	0553600	248	0575600	249
0426001	164	0491303	171	0512500	254	0528300	247	0542400	247	0553800	248	0575700	249
0426701	164	0494802	172	0512800	254	0528400	247	0542900	247	0553900	248	0575800	249
0426701	190	0494802	224	0512900	254	0528500	247	0543300	247	0554300	248	0575900	249
0427001	158	0494804	172	0513200	254	0528800	247	0543400	247	0554500	259	0576000	249
0428006	310	0494902	172	0513300	255	0529000	247	0543500	247	0554600	259	0576100	249
0432304	166	0494902	224	0513400	255	0529100	247	0543700	248	055501	67	0576200	249
0432403	308	0494904	172	0513500	255	0529500	247	0543900	248	0559600	259	0576300	249
0432501	189	0495002	172	0513600	255	0529600	247	0544000	248	0560200	249	0576600	249
0439503	16	0495002	224	0514500	255	0529700	247	0544100	248	0560300	249	0577600	249
0439503	110	0495004	172	0514600	255	0529800	247	0544175	170	0560600	249	0577700	249
0439603	16	0500700	252	0514900	255	0529900	247	0544404	176	0560700	249	0577800	249
0439603	110	0502102	105	0516900	255	0530200	247	0544500	248	0560800	249	0577900	249
0441811	230	0502102	171	0517100	247	0530900	247	0544600	248	0560900	249	0578000	249
0441911	230	0502104	105	0517200	247	0531000	247	0544700	248	0561000	249	0578300	249
0442303	164	0502104	171	0517700	247	0531100	247	0544800	248	0561100	249	0578700	249
0442304	164	0503401	153	0517800	247	0531200	247	0544900	248	0561200	249	0578800	249
0443501	189	0503401	222	0518800	247	0531300	247	0545000	248	0561500	249	0578900	249
0444500	306	0503402	153	0518900	247	0531400	247	0545100	248	0561600	249	0579000	249
0445000	22	0503402	222	0520300	247	0531500	247	0545200	248	0562400	249	0579100	249
0445300	22	0503501	153	0520400	247	0531700	247	0545300	248	0562500	249	0579200	249
0445600	22	0503501	222	0520900	247	0532500	247	0545400	248	0562700	249	0579300	249
0450206	233	0503502	153	0521900	247	0532600	247	0545500	248	0562900	249	0579400	249
0452200	210	0503502	222	0522000	247	0532700	247	0545600	248	0563100	249	0579500	249
0454501	295	0503602	153	0522300	247	0532800	247	0545700	248	0563300	249	0579600	249
0454503	295	0503602	222	0522400	247	0532900	247	0545800	248	0563500	249	0579700	249
0455803	96	0503800	252	0522500	247	0533000	247	0545900	248	0563700	249	0579800	249
0455900	161	0504701	157	0522700	247	0533100	247	0546000	248	0563900	249	0579900	249
0456000	161	0504703	157	0522900	247	0533600	247	0546100	248	0564100	249	0580000	249
0456601	232	0504900	252	0523000	247	0534800	247	0546400	248	0564300	249	0580100	249
0457001	227	0505000	252	0523500	247	0534900	247	0546500	248	0564500	249	0580200	249
0459401	150	0505100	252	0523600	247	0535000	247	0546600	248	0564700	249	0580400	249
0464604	173	0505200	252	0524601	159	053501	67	0547200	248	0567700	249	0580500	249
0465004	173	0505300	252	0525200	247	0535900	247	0547300	248	0567800	249	0580600	249
0465202	154	0505400	252	0525601	157	0536100	247	0547400	248	0568400	249	0580700	249
0465202	223	0507400	252	0526101	159	0536300	247	0547600	248	0568500	249	0580900	249
0465502	154	0507500	252	0526103	159	0536600	247	0547900	248	0568800	249	0581300	249
0465502	223	0507600	252	0526106	159	0536700	247	0548000	248	0569100	249	0581400	249
0465602	154	0507700	252	0526201	159	0537000	247	0548600	248	0569900	249	0583900	249
0465602	223	0507900	252	0526203	159	0537100	247	0548700	248	0570100	249	0584100	249
0465702	230	0508000	252	0526400	247	0537200	247	0550000	248	0570300	249	0584400	249
0466102	173	0508600	252	0526500	247	0537300	247	0551000	248	0570700	249	0584800	249
0466202	173	0508700	253	0526600	247	0537400	247	0551200	248	0571100	249	0584900	249
0467801	189	0509100	253	0526700	247	0537500	247	0551300	248	0571700	249	0585000	249
0485001	90	0509801	292	0526800	247	0537600	247	0551600	248	0571900	249	0585400	249
0485101	90	0509900	253	0526900	247	0538000	247	0551700	248	0572100	249	0585700	249
0485201	90	0510500	254	0527300	247	0538200	247	0551800	248	0572200	249	0585800	249
0491003	173	0510600	254	0527400	247	0539100	247	0551900	248	0573100	249	0586000	249
0491003	224	0511100	254	0527600	247	0540600	247	0552200	248	0573500	249	0586200	249
0491004	173	0511300	254	0527800	247	0540900	247	0552300	248	0573600	249	0586400	249

INDEX NUMÉRIQUE

0586600	249	0599300	243	0601843	251	0601920	250	0602024	244	0602078	250	0602132	246
0586900	249	0599400	243	0601844	251	0601921	250	0602025	244	0602079	250	0602133	246
0587000	249	0599500	243	0601845	251	0601922	250	0602026	244	0602080	250	0602134	246
0587100	259	0599600	243	0601846	251	0601923	250	0602027	244	0602081	250	0602135	246
0587700	259	0599700	243	0601847	251	0601924	250	0602028	244	0602082	250	0602136	246
0587800	259	0599800	243	0601848	251	0601925	250	0602029	244	0602083	250	0602137	246
0587900	259	0599900	243	0601850	251	0601926	250	0602030	244	0602084	250	0602138	246
0588000	259	0600200	243	0601851	251	0601927	250	0602031	244	0602085	250	0602139	246
0588100	259	0600300	243	0601852	251	0601928	250	0602032	244	0602086	250	0602140	246
0588200	259	0600400	243	0601857	251	0601929	250	0602033	244	0602087	250	0602141	246
0588300	259	0601800	251	0601858	251	0601930	250	0602034	244	0602088	250	0602142	246
0588900	243	0601801	251	0601859	251	0601931	250	0602035	244	0602089	250	0602143	246
0589700	243	0601802	251	0601864	251	0601932	250	0602036	244	0602090	250	0602144	246
0589800	243	0601803	251	0601865	251	0601933	250	0602037	244	0602091	250	0602145	246
0589900	243	0601804	251	0601866	251	0601934	250	0602038	244	0602092	250	0602146	246
0590000	243	0601805	251	0601871	251	0601935	250	0602039	244	0602093	250	0602147	246
0590300	243	0601806	251	0601872	251	0601936	250	0602040	244	0602094	250	0602148	246
0590600	243	0601807	251	0601873	251	0601937	250	0602041	244	0602095	250	0602700	243
0590800	243	0601808	251	0601878	251	0601938	250	0602042	244	0602096	250	0603900	243
0591100	181	0601809	251	0601879	251	0601939	250	0602043	244	0602097	250	0604000	243
0591200	243	0601810	251	0601880	251	0601940	250	0602044	244	0602098	250	0604500	243
0591300	243	0601811	251	0601881	251	0601941	250	0602045	244	0602100	246	0604600	243
0592400	243	0601812	251	0601882	251	0601942	250	0602046	244	0602101	246	0604700	243
0592500	243	0601813	251	0601885	251	0601943	250	0602047	244	0602102	246	0604900	243
0592600	243	0601814	251	0601886	251	0601944	250	0602048	244	0602103	246	0606000	211
0593400	243	0601815	251	0601887	251	0601945	250	0602050	250	0602104	246	0606900	243
0593500	243	0601816	251	0601888	251	0601946	250	0602051	250	0602105	246	0607000	243
0593700	243	0601817	251	0601889	251	0601947	250	0602052	250	0602106	246	0607100	243
0594100	243	0601818	251	0601892	251	0601948	250	0602053	250	0602107	246	0607200	243
0594200	243	0601819	251	0601893	251	0602000	244	0602054	250	0602108	246	0607400	243
0594400	243	0601820	251	0601894	251	0602001	244	0602055	250	0602109	246	0607500	243
0594500	243	0601821	251	0601895	251	0602002	244	0602056	250	0602110	246	0607700	243
0594600	243	0601822	251	0601896	251	0602003	244	0602057	250	0602111	246	0607800	243
0595300	243	0601823	251	0601900	250	0602004	244	0602058	250	0602112	246	0607900	243
0595500	243	0601824	251	0601901	250	0602005	244	0602059	250	0602113	246	0608000	243
0595900	243	0601825	251	0601902	250	0602006	244	0602060	250	0602114	246	0608100	243
0596000	243	0601826	251	0601903	250	0602007	244	0602061	250	0602115	246	0608200	243
0596100	243	0601827	251	0601904	250	0602008	244	0602062	250	0602116	246	0608400	243
0596700	243	0601828	251	0601905	250	0602009	244	0602063	250	0602117	246	0608500	243
0597100	243	0601829	251	0601906	250	0602010	244	0602064	250	0602118	246	0608700	243
0597300	243	0601830	251	0601907	250	0602011	244	0602065	250	0602119	246	0608800	243
0597400	243	0601831	251	0601908	250	0602012	244	0602066	250	0602120	246	0608900	243
0597600	243	0601832	251	0601909	250	0602013	244	0602067	250	0602121	246	0610000	243
0597800	243	0601833	251	0601910	250	0602014	244	0602068	250	0602122	246	0610300	243
0598000	243	0601834	251	0601911	250	0602015	244	0602069	250	0602123	246	0610400	243
0598100	243	0601835	251	0601912	250	0602016	244	0602070	250	0602124	246	0610500	243
0598200	243	0601836	251	0601913	250	0602017	244	0602071	250	0602125	246	0610600	243
0598300	243	0601837	251	0601914	250	0602018	244	0602072	250	0602126	246	0610700	243
0598600	243	0601838	251	0601915	250	0602019	244	0602073	250	0602127	246	0610800	243
0598900	243	0601839	251	0601916	250	0602020	244	0602074	250	0602128	246	0610900	243
0599000	243	0601840	251	0601917	250	0602021	244	0602075	250	0602129	246	0611300	243
0599100	243	0601841	251	0601918	250	0602022	244	0602076	250	0602130	246	0611500	243
0599200	243	0601842	251	0601919	250	0602023	244	0602077	250	0602131	246	0612000	243

INDEX NUMÉRIQUE

0612400	243	0623100	245	0644300	244	0662601	148	0667001	149	0677700	246	0705903	192
0612600	243	0623200	245	0645000	181	0662603	148	0667003	149	0677800	262	0705903	235
0612800	243	0623600	245	0645400	244	0662701	148	0667100	246	0677900	262	0706003	192
0613000	243	0624100	245	0645500	244	0662703	148	0667200	246	0678000	262	0706003	235
0613300	243	0624400	245	0645600	244	0662801	148	0667300	246	0678936	27	0706100	20
0613400	243	0624500	245	0645700	244	0662803	148	0667400	246	0679400	262	0706200	20
0613500	243	062520	68	0645800	244	0663001	148	0667501	149	0679600	262	0706800	174
0613600	243	062550	68	0647300	244	0663003	148	0667600	246	0679800	262	0707003	193
0613700	243	0625500	245	0647400	244	0663101	148	0667701	149	0680200	262	0707003	237
0613900	243	062560	68	0648500	244	0663103	148	0667703	149	0680500	262	0707004	193
0614000	243	062570	68	0648700	244	0663201	148	0667801	149	0680600	262	0707004	237
0614100	243	0625700	245	0649200	244	0663203	148	0668100	246	0680700	262	0707306	148
0614200	245	0626700	245	0650600	244	0663300	245	0670000	246	0680800	262	0707406	148
0614500	245	0626800	245	0650700	244	0663401	148	0670300	246	0680900	262	0707506	148
0614700	245	0627400	245	0651300	244	0663403	148	0670400	246	0681000	241	0707606	148
0615000	245	0628100	245	0651400	244	0663500	245	0670500	246	0681100	241	0708100	310
0615100	245	0628700	245	0651500	244	0663601	148	0670600	246	0681400	241	0708200	211
0615200	245	0630200	259	0651600	244	0663603	148	0670700	246	0681600	256	0708300	211
0615300	245	0630300	259	0651700	244	0663701	148	0670900	246	0681700	256	0708350	211
0615400	245	0630400	259	0652000	244	0663703	148	0671100	246	0681800	256	0708400	294
0615500	245	0630500	259	0652200	244	0663801	149	0671200	246	0682500	257	0708500	295
0615600	245	0631300	259	0652500	244	0663803	149	0671300	246	0682800	257	0711503	192
0615700	245	0632600	259	0652600	244	0663901	149	0671700	246	0683100	257	0711503	235
0615800	245	0632700	244	0653200	244	0663903	149	0672300	246	0683200	258	0711504	192
0615900	245	0633800	244	0653400	244	0664000	245	0672500	246	0683300	258	0711504	235
0616000	245	0633900	244	0653500	244	0664100	245	0672600	246	0683400	258	0711603	192
0616100	245	0634000	244	0653600	244	0664200	245	0672700	246	0683500	258	0711603	235
0616200	245	0634100	244	0654000	245	0664300	245	0672900	246	0692500	262	0711803	218
0616900	245	0634900	221	0654100	245	0664400	245	0673100	246	0692600	310	0723901	166
0617000	245	0634900	312	0654300	245	0664500	245	0673300	246	0692900	308	0724001	166
0617100	245	0635000	221	0654600	245	0664600	245	0673500	246	0693300	307	0724103	106
0617300	245	0635000	312	0654700	245	0664700	245	0673700	246	0693800	307	0724103	171
0617400	245	0637300	244	0654900	245	0664801	149	0673900	246	0694000	307	0724701	166
0617600	245	0637400	244	0655100	245	0664803	149	0674100	246	0694100	307	0724901	166
0617700	245	0637500	244	0655300	245	0664900	245	0674200	246	0694600	211	0725302	230
0618700	245	0637600	244	0655600	245	0665100	245	0674500	246	0694800	210	0725311	230
0619600	245	0637801	157	0655700	245	0665200	245	0674800	246	0694900	227	0725402	230
0619700	245	0638100	244	0655900	245	0665300	245	0674900	246	0699900	257	0725411	230
0619900	245	0639800	244	0656100	245	0665400	245	0675000	246	0700000	262	0725502	230
0620000	245	0639900	244	0656300	245	0665500	245	0675100	246	0700103	194	0725511	230
0620100	245	0640000	244	0656700	245	0665600	245	0675200	246	0700103	238	0725602	230
0620300	245	0640300	244	0657000	245	0665700	245	0675300	246	0700104	194	0725611	230
0620700	245	0640400	244	0657100	245	0665801	149	0675400	246	0700104	238	0725702	230
0620900	245	0640500	244	0657600	245	0665803	149	0675600	246	0700426	208	0725711	230
0621600	245	0640903	192	0658200	245	0665901	149	0675700	246	0701503	196	0730402	17
062170	68	0640903	235	0658400	245	0665903	149	0676300	246	0703204	175	0733601	148
062190	68	0642100	244	0658800	245	0666000	245	0676400	246	0703304	175	0733801	148
0621900	245	0642800	244	0658900	245	0666400	245	0676800	246	0703404	174	0733901	148
062210	68	0643200	244	0661200	181	0666500	245	0676900	246	0703504	174	0735501	149
062215	68	0643300	244	0661400	245	0666600	245	0677100	246	0704203	198	0739803	218
062220	68	0643500	244	0661900	245	0666700	245	0677200	246	0704404	193	0741500	306
0622500	245	0644000	244	0662000	245	0666800	245	0677400	246	0704404	237	0741600	306
0623000	245	0644100	244	0662500	245	0666900	246	0677600	246	0705503	27	0741650	312

INDEX NUMÉRIQUE

0742500	210	0804703	165	0851300	207	0931702	308	0953000	166	0960600	198	0971526	86
0742801	155	0804801	157	0851400	206	0932401	293	0953101	155	0960600	213	0971626	86
0744601	155	0805401	159	0851500	201	0932503	293	0953204	152	0960700	298	0972426	86
0745200	25	0807701	157	0851600	208	0932601	167	0953302	170	0960900	299	0972526	86
0745400	25	0807703	157	0851700	207	0933300	204	0953401	152	0961300	309	0977201	148
0745500	25	0808501	149	0851800	206	0933400	203	0953500	163	0961403	198	0977301	148
0745504	25	0808701	149	0851900	206	0936000	229	0953600	163	0961403	213	0977401	148
0745600	25	0808901	149	0867602	308	0938000	229	0953703	162	0961503	196	0977501	148
0745604	25	0809101	149	0875201	158	0938526	298	0953803	162	0961603	196	0977601	148
0745800	24	0812403	173	0875203	158	0941201	227	0953900	162	0961700	186	0977701	148
0745900	24	0812403	224	0877600	201	0941301	299	0954000	162	0961800	186	0977801	148
0746000	22	0812404	173	0877700	201	0941401	298	0954100	185	0961900	186	0977901	148
0746100	22	0812701	169	0877900	201	0941501	167	0954200	185	0962000	186	0980001	161
0746200	22	0812703	169	0878100	201	0941601	174	0954301	174	0962100	183	0980101	161
0754300	27	0812901	169	0878703	293	0941700	186	0954401	174	0962200	183	0980301	161
0774801	157	0812903	169	0878803	293	0941801	169	0954500	27	0962300	303	0980401	161
0774803	157	0813001	169	0881200	207	0941901	169	0954600	27	0962600	298	0980501	174
0777406	194	0813003	169	0882904	290	0942001	232	0954700	212	0962703	198	0980601	174
0777406	238	0819601	150	0883003	290	0942100	183	0954801	167	0962703	213	0980701	174
0783304	232	0819701	150	0883004	290	0942200	16	0954926	182	0962803	197	0981201	174
0785601	149	0819801	151	0885001	293	0942200	110	0955206	182	0963001	173	0983201	174
0785701	149	0819803	151	0886701	293	0942301	293	0955504	152	0963101	173	0983301	174
0786901	148	0823100	24	0888003	232	0942401	159	0955604	152	0963201	184	0988001	176
0787501	190	0840700	200	0890800	131	0942501	157	0955800	212	0963226	184	0988201	176
0787901	148	0840900	200	0890900	131	0942601	151	0956100	184	0963400	163	0988500	298
0787903	148	0841100	202	0892703	294	0942703	194	0956501	166	0963500	298	0989000	299
0788301	149	0841200	200	0894800	300	0942703	238	0956626	167	0963600	298	0989050	299
0789101	148	0841300	200	0894900	300	0942904	177	0956701	157	0963701	178	0989100	299
0789103	148	0842000	207	0896100	20	0943201	148	0956704	167	0963800	202	0989200	298
0789301	149	0842200	201	0900602	316	0943301	148	0956801	184	0963916	197	0989300	312
0792801	150	0842400	201	0900701	166	0943401	148	0956900	205	0964000	307	0989400	312
0793001	151	0842600	201	0900901	161	0943501	148	0957000	204	0964102	307	0989500	312
0793201	150	0842800	201	0901001	100	0943601	149	0957100	204	0964202	307	0994000	69
0793401	150	0843200	202	0901001	123	0943701	149	0957303	197	0964300	299	0994301	159
0793601	151	0843500	202	0903001	100	0943801	149	0957400	303	0964350	299	0994302	159
0793801	149	0843600	202	0903001	123	0943901	149	0957500	303	0964400	299	0994306	159
0794601	149	0843700	202	0903101	100	0944001	150	0957603	292	0964501	160	0994401	159
0794701	149	0843950	207	0903101	123	0944200	114	0957701	292	0964626	307	0994800	168
0797701	148	0843980	207	0903902	231	0951600	182	0957801	175	0964800	175	0994900	168
0797703	148	0844000	202	0904103	161	0951700	182	0957904	175	0965106	19	0995100	300
0797801	149	0844100	202	0904104	161	0951750	182	0958200	173	0965206	19	0995600	300
07PNC3B14	174	0844800	204	0904204	161	0951800	182	0958300	175	0965306	19	0995700	300
0801903	192	0845100	204	0904303	161	0951900	182	0958400	229	0965406	19	0995800	24
0801903	235	0846200	203	0904304	161	0952000	162	0958400	299	0965506	19	0995900	24
0802103	192	0846500	203	0904403	161	0952100	162	0958500	167	0965606	19	0996000	24
0802103	235	0847500	206	0904404	161	0952303	196	0958500	183	0968926	86	0996100	24
0802203	193	0848600	205	0912526	86	0952400	167	0959800	185	0969026	86	0996200	24
0802203	237	0848700	205	0912926	86	0952400	183	0959900	163	0969126	86	0996300	221
0802204	193	0849000	205	0913226	86	0952501	155	0959900	181	0969226	86	0996400	221
0802204	237	0849500	205	0926502	308	0952604	178	0960000	163	0970503	20	0996500	208
0804601	165	0850500	203	0926602	308	0952701	189	0960000	181	0970603	20	0996600	152
0804603	165	0851000	203	0926702	306	0952801	292	0960500	198	0971326	86	0996700	152
0804701	165	0851200	207	0926802	306	0952900	178	0960500	213	0971426	86	0996800	152

INDEX NUMÉRIQUE

0996900	152	1084600	33	1093500	35	1129100	42	1135500	46	1156800	50	1162100	56
0997000	152	1084700	31	1093600	35	1129200	42	1135600	46	1156900	50	1162200	56
0997200	309	1084800	31	1093700	35	1129700	42	1135700	46	1157000	50	1162300	56
0997300	182	1084900	31	1093800	35	1129800	42	1135800	46	1157100	51	1162400	56
0997400	182	1085000	31	110036	155	1129900	42	1135900	46	1157200	51	1162500	56
100058	309	1085100	31	110040	155	1130000	42	1136000	46	1157300	51	1162600	56
1010600	182	1085200	31	11021100CB	59	1130100	43	1136100	46	1157400	51	1162700	56
1010700	182	1085300	31	11021100CS	60	1130600	43	1136200	47	1157500	51	1162800	56
1018302	208	1085400	31	11021100FB	58	1130700	43	1136300	47	1157600	51	1162900	56
105031	218	1085500	31	1110103	241	1130800	43	1136400	47	1157700	51	1163000	56
105036	218	1085600	31	1110203	241	1130900	41	1136500	47	1157800	51	1163100	56
105041	218	1085700	31	1113101	148	1131000	41	1136600	47	1157900	51	1163200	61
105055	221	1085800	31	1113201	148	1131100	41	1136700	47	1158000	51	1163300	61
105055	312	1085900	32	1123700	36	1131200	41	1136800	47	1158100	51	1163400	61
105070	27	1086000	32	1123800	36	1131300	43	1136900	47	1158200	51	1163500	61
105075	27	1086100	32	1123900	36	1131400	43	1137000	47	1158300	52	1163600	61
105076	27	1086200	32	1124000	36	1131500	43	1137100	47	1158400	52	1163700	61
105080	27	1086300	32	1124700	37	1131600	43	1137200	47	1158500	52	1163800	61
1058806	241	1086400	32	1124800	37	1131700	41	1137300	47	1158600	52	1163900	61
1078626	86	1086500	32	1124900	37	1131800	41	1137400	48	1158700	52	1164000	61
1078726	86	1086600	32	1125000	37	1131900	41	1137500	48	1158800	52	1164100	61
1078826	86	1088300	34	1125200	37	1132000	41	1137600	48	1158900	52	1164200	61
1078926	86	1088400	34	1125400	37	1132100	44	1137700	48	1159000	52	1164300	61
1079026	86	1088500	34	1125500	37	1132200	44	1137800	48	1159100	52	1164400	61
1079126	86	1088600	34	1125600	37	1132300	44	1137900	48	1159200	52	1164500	61
1079226	86	1089900	34	1125700	38	1132400	44	1138000	48	1159300	52	1164600	61
1081500	32	1090000	34	1125800	38	1132500	43	1138100	48	1159400	52	1164700	62
1081600	32	1090100	34	1125900	39	1132600	43	1138200	48	1159500	52	1164800	62
1081700	32	1090200	34	1126000	39	1132700	43	1138300	48	1159600	52	1164900	62
1081800	32	1090300	34	1126100	39	1132800	43	1138400	48	1159700	52	1165000	62
1081900	33	1090400	34	1126200	38	1132900	41	1138500	48	1159800	52	1165100	62
1082000	33	1090500	34	1126300	38	1133000	41	1138600	48	1159900	53	1165200	62
1082100	33	1090600	34	1126400	39	1133100	41	1154700	49	1160000	53	1165300	62
1082200	33	1090700	36	1126500	38	1133200	41	1154800	49	1160100	53	1165400	62
1082700	30	1090800	36	1126600	38	1133300	44	1154900	49	1160200	53	1165500	62
1082800	30	1090900	36	1126700	40	1133400	44	1155000	49	1160300	53	1165600	62
1082900	30	1091000	36	1126800	40	1133500	44	1155100	49	1160400	53	1165700	62
1083000	30	1091100	36	1126900	40	1133600	44	1155200	49	1160500	53	1165800	62
1083100	30	1091200	36	1127000	40	1133700	44	1155300	49	1160600	54	1165900	62
1083200	30	1091300	36	1127100	40	1133800	44	1155400	49	1160700	54	1166000	62
1083300	30	1091400	36	1127300	40	1133900	44	1155500	49	1160800	54	1166100	62
1083400	30	1091500	36	1127500	42	1134000	44	1155600	49	1160900	54	1166200	63
1083500	33	1091600	36	1127600	41	1134200	45	1155700	49	1161000	54	1166300	63
1083600	33	1091700	36	1127700	41	1134300	45	1155800	49	1161100	54	1166400	63
1083700	33	1091800	36	1127800	41	1134400	45	1155900	50	1161200	54	1166500	63
1083800	33	1092300	35	1127900	41	1134500	45	1156000	50	1161300	55	1166600	63
1083900	30	1092400	35	1128000	41	1134600	45	1156100	50	1161400	55	1166700	63
1084000	30	1092500	35	1128100	42	1134700	45	1156200	50	1161500	55	1166800	63
1084100	30	1092600	35	1128200	42	1135000	45	1156300	50	1161600	55	1166900	63
1084200	30	1093100	35	1128300	42	1135100	45	1156400	50	1161700	55	1167000	63
1084300	33	1093200	35	1128400	42	1135200	45	1156500	50	1161800	55	1167100	63
1084400	33	1093300	35	1128900	42	1135300	46	1156600	50	1161900	55	1167200	63
1084500	33	1093400	35	1129000	42	1135400	46	1156700	50	1162000	56	1167300	63

INDEX NUMÉRIQUE

1167400	63	1902102	153	25618004	99	402104	77	500030	321	518004	314	530160	18
1167500	63	1902102	222	25618060	101	402110	77	500118	322	518221	314	530170	18
1167600	63	2000100CB	59	25618080	101	403101	81	501051	315	518231	314	530220	18
1167700	63	2000100CS	60	25618100	101	403102	81	501061	315	518321	314	530230	18
1167800	63	2000100FB	58	25618120	101	403103	81	501081	315	518331	314	530280	18
1167900	63	2000200CB	59	3138128	105	403110	81	501091	315	518371	314	530290	18
1168000	63	2000200CS	60	3141140	105	403115	82	501101	315	520350	165	530300	18
1168100	63	2000200FB	58	3401501	114	404101	83	501111	315	520355	165	530330	18
1168200	64	2000300CB	59	3401601	114	404102	83	501121	315	522006	230	530380	18
1168300	64	2000300CS	60	3401701	114	404103	83	501129	315	522010	230	530410	18
1168400	64	2000300FB	58	3402502	120	404104	83	501141	315	522041	230	530460	18
1168500	64	2000500CB	59	3405301	120	404110	83	501151	315	522081	230	530470	18
1168600	64	2000500CS	60	3405402	120	405101	78	501161	315	522340	227	530520	18
1168700	64	2000500FB	58	3405501	120	405112	84	501315	182	522350	227	530530	18
1168800	64	2011150	210	3405601	120	405121	84	501320	182	522351	227	530540	18
1168900	64	2011200	210	3411401	116	405122	84	501345	298	522361	227	530570	18
1169000	64	2011300	210	3413802	119	405123	84	502182	26	522386	233	530620	18
1169100	64	2014250	215	3421101	117	405124	84	502292	295	524010	230	530630	18
133029	296	2014250	231	3440101	112	4172034	177	502295	295	524041	230	530640	18
1401415	180	2014300	215	3440201	112	4239034	177	502310	295	524071	230	530670	18
1401560	180	2014300	231	3450201	125	440188	240	503005	26	524081	230	530740	18
1402355	180	2014400	215	3450601	125	440301	240	503006	26	524340	227	530760	18
1402500	180	2014400	231	3450901	125	440302	240	503476	173	524350	227	530880	18
1403415	180	202293	294	3450922	125	440303	240	503476	224	524351	227	530890	18
1403560	180	202294	294	3451201	125	440305	240	503480	173	524361	227	530910	18
1404370	180	2050014	215	3451302	125	440306	240	503480	224	529077	318	532320	19
1404515	180	2050014	226	3452501	125	440307	240	503496	173	529079	318	532320	210
1405645	180	205012	215	3453201	125	440551	240	503500	173	529148	318	532325	19
151050	168	205012	226	3454601	124	440552	240	503511	316	529181	169	532325	210
152060	168	206001	215	3454701	124	440553	240	503664	92	529183	169	532330	19
168440	234	206001	226	3454801	124	440555	240	503670	92	529202	169	532330	210
168440	296	2060014	215	3454901	124	440556	240	503675	92	529261	318	532335	19
176010	150	2060014	227	3456401	124	440557	240	503680	92	529271	318	532335	210
176011	150	206002	215	3456502	124	440991	240	503685	92	529482	317	532340	19
177003	219	206002	227	3462701	123	440992	240	504982	26	529661	317	532340	210
177004	219	242010	102	3498501	127	440993	240	504984	26	529671	317	532345	19
177005	219	242030	102	3498701	127	440995	240	504986	26	529681	317	532345	210
177006	219	242040	102	3499501	128	440996	240	504988	26	529781	317	532350	19
177008	220	242050	102	3499701	128	440997	240	504994	26	529791	317	532350	210
177009	220	242060	102	401101	75	4631001	183	504996	26	529801	317	532355	19
177010	220	242070	102	401102	75	4631002	183	506051	318	529870	96	532355	210
177011	220	242090	102	401103	75	465626	185	507183	25	529875	96	532630	20
177012	219	242110	102	401104	75	465627	185	507461	318	529880	96	532660	20
177013	221	242120	102	401105	75	500014	320	507471	318	529885	96	532920	20
177014	221	242130	102	401106	75	500015	320	507481	318	529890	96	532930	20
177015	220	242140	102	401107	75	500016	322	512023	68	530020	18	534280	23
177016	219	242150	102	401108	75	500017	320	516340	317	530030	18	534290	23
177017	219	25617030	98	401110	75	500019	322	516350	317	530040	18	534840	20
177018	220	25617040	98	401115	78	500022	324	516380	317	530050	18	534850	20
179301	159	25617050	98	401120	75	500023	323	516390	317	530080	18	535130	23
179302	159	25617060	98	402101	77	500024	324	516400	317	530090	18	535150	23
179320	159	25617070	98	402102	77	500025	323	518002	314	530140	18	535170	23
183011	26	25617080	98	402103	77	500029	321	518003	314	530150	18	535200	23

INDEX NUMÉRIQUE

535680	23	542320	156	579405	160	6118200	101	6173080	118	6217070	99	627205	16
535700	23	542330	156	597012	21	6121035	107	6173100	118	6217100	99	627205	110
535720	23	542340	156	600910	69	6121040	107	6173120	118	6217120	99	627210	16
535820	22	542350	156	602031	307	6121045	107	6173140	118	6217140	99	627210	110
535840	22	542360	156	602040	177	6121060	107	6173160	118	6217160	99	627215	16
535850	22	542370	156	6030180	90	6123001	104	6173170	118	6217190	99	627215	110
535860	22	542445	103	6030200	90	6123003	104	6175200	112	6217220	99	627220	16
535880	20	542455	103	6030250	90	6125408	117	6175300	112	6217250	99	627220	110
535890	20	542470	103	6030330	90	6127032	124	6175400	112	6218060	99	627235	16
535910	20	542475	103	6031250	91	6130060	17	6176004	16	6218080	99	627235	110
537140	19	542485	103	6031300	91	6130080	17	6176004	111	6218100	99	629330	210
537150	19	542495	103	6031350	91	6130095	17	6176005	16	6218120	99	629340	210
537160	19	542540	103	603220	307	6130125	17	6176005	111	6218140	99	629350	210
537170	19	542550	103	605012	315	6130160	17	6176008	16	6218160	99	629360	210
537190	19	542610	103	606030	315	6131080	17	6176008	111	6218190	99	629460	151
537220	19	542710	21	606032	315	6131095	17	6176012	16	6218220	99	629465	151
537230	19	542730	21	609013	315	6131125	17	6176012	111	6220050	108	629470	151
538055	176	542750	21	6102075	102	6133008	17	6177005	172	6226040	100	629475	151
538070	196	542770	21	6103075	170	6133012	17	6177005	224	624070	153	629605	151
538071	196	542830	21	6104009	170	6133014	17	6177060	172	624070	222	629610	151
538080	196	542970	21	6106134	170	6133016	17	6177060	224	624090	153	629615	151
538081	196	544020	25	6106234	170	6133019	17	6177080	172	624090	222	629761	152
538090	196	544110	25	6107031	102	6134080	17	6177080	224	624092	153	629763	152
538130	192	544310	22	610985	315	6134120	17	6177100	172	624092	222	629765	152
538130	236	544320	22	6112595	104	6134140	17	6177100	224	624094	153	629767	152
538140	192	544330	22	6114080	108	6134160	17	6177120	172	624094	222	629780	152
538140	236	544340	22	6115105	107	6134190	17	6177120	224	624095	153	629791	152
541500	102	544350	22	6116035	25	6134220	17	6177140	172	624095	222	629793	152
541510	102	544360	22	6116040	25	6139025	192	6177140	224	624096	153	629795	152
541520	102	544370	22	6116045	25	6139025	236	6177160	172	624096	222	629797	152
541530	102	544520	103	6116050	25	6139036	192	6177160	224	624105	153	629798	152
541540	102	544530	103	6116055	25	6139036	236	6177180	172	624105	222	629799	152
541550	102	544540	103	6116060	25	6141120	108	6177180	224	624110	153	629850	240
541560	102	544550	103	6116070	108	6141140	108	6177200	172	624110	222	629874	210
541570	102	546945	21	6116080	25	6146002	106	6177200	224	624115	153	629877	210
541580	102	546946	21	6116100	25	6147500	106	61ISOXT35M	189	624115	222	630001	22
541590	102	546947	21	6117030	98	6149014	106	620093	178	624155	153	630002	22
541610	102	546948	21	6117040	98	6149014	171	620099	177	624155	222	630031	24
541620	102	547016	21	6117050	98	6149016	106	620500	185	624160	153	6318140	99
541630	102	547017	21	6117060	98	6149016	171	620502	185	624160	222	6318160	99
541640	102	547018	21	6117070	98	6149019	106	620632	175	624165	153	6318180	99
541650	102	547019	21	6117075	107	6149019	171	620651	175	624165	222	6318240	99
541820	102	547020	21	6117080	98	6158100	105	620653	175	624170	153	6318260	99
541830	102	55021100CB	59	6117090	98	6158100	171	6208075	107	624170	222	6318280	99
541840	102	55021100CS	60	6117100	98	6160070	316	6213030	104	6245030	108	6319100	100
541850	102	55021100FB	58	6117120	98	617005	316	6213038	104	6245040	108	6319120	100
541860	102	575050	302	6117140	98	617006	316	6213607	103	6246500	106	6326040	100
541870	102	579013	157	6118060	101	617007	316	6213609	103	627005	302	6327040	100
541880	102	579014	157	6118080	101	617008	316	6214125	104	627160	16	633801	96
541890	102	579151	158	6118100	101	617009	316	6214225	104	627160	110	6407115	126
541910	102	579152	158	6118120	101	617010	316	621430	168	627170	16	6407117	126
542270	103	579160	158	6118140	101	6173040	118	6216090	108	627170	110	6410260	112
542280	103	579161	158	6118160	101	6173050	118	6217050	99	627200	16	6410261	112
542290	103	579401	160	6118180	101	6173070	118	6217060	107	627200	110	6410279	114

INDEX NUMÉRIQUE

6410280	114	685835	290	739815	159	8002070	91	8062160	99	8207020	223	859514	229
641110	111	685840	290	752804	150	8002090	91	8062190	99	8207025	154	860514	231
6411992	130	685850	290	752805	150	8002135	91	8068150	89	8207025	223	860886	230
6411993	130	685851	290	756815	154	8003200	91	8068200	89	8207030	154	861214	215
6411994	128	685852	290	756815	223	8008100	89	8068250	89	8207030	223	861214	228
6411995	128	686850	291	756820	154	8008125	89	8068300	89	8207035	154	861810	228
6411998	128	686851	291	756820	223	8008150	89	8069125	92	8207035	223	861812	228
6411999	128	686852	291	756825	154	8008200	89	8069175	92	8207040	154	863810	231
6418100	101	686853	291	756825	223	8008250	89	8069225	92	8207040	223	870950	234
6418120	101	692801	233	756915	154	8008300	89	8070070	95	8207050	154	870950	296
6418140	101	7116003	231	756915	223	8017030	98	8118001	230	8207050	223	8817030	98
6418160	101	7116003	304	756920	154	8017040	98	8121075	88	8207060	154	8817040	98
6418190	101	7116004	231	756920	223	8017050	98	8121100	88	8207060	223	8817050	98
6418220	101	7116004	304	756925	154	8017060	98	8121125	88	8221075	88	8817060	98
6429003	131	7150016	106	756925	223	8017070	98	8121150	88	8221100	88	8914105	92
6429004	131	7150016	171	757830	154	8017080	98	8121200	88	8221125	88	8914115	92
6475060	107	7150019	106	757830	223	8017100	98	8121250	88	8221150	88	9001156	98
656110	101	7150019	171	757835	154	802015	88	8121300	88	8221200	88	9001312	104
656111	101	7158085	105	757835	223	802020	88	8121350	88	8221250	88	9002501	89
656115	101	7158085	171	757840	154	802025	88	8121400	88	8221300	88	9002502	89
656116	101	7167000	115	757840	223	8021075	88	8130100	90	8227160	95	9002503	89
656120	101	7167160	115	757850	154	8021100	88	8130125	90	8229078	95	9002521	89
656121	101	7167220	115	757850	223	8021125	88	8130150	90	824049	294	9002522	89
66021100CB	59	7167300	115	757860	154	8021150	88	8149014	106	825814	291	9002523	89
66021100CS	60	7172034	177	757860	223	8021200	88	8149014	171	825816	291	9002531	89
66021100FB	58	7175070	118	757870	156	8021250	88	8149016	106	825916	291	9002532	89
671008	214	7175090	118	757871	156	8021300	88	8149016	171	826814	291	9002583	89
671008	316	7175120	118	757930	154	8021350	88	8149019	106	826816	291	9002621	91
671012	214	7175130	118	757930	223	8021400	88	8149019	171	826822	291	9002622	91
671012	316	7207150	154	757935	154	8026096	89	8150012	106	8517030	98	9002623	91
671016	214	7207150	223	757935	223	8026110	89	8150012	171	8517040	98	9002701	91
671016	316	7207200	154	757940	154	8026140	89	8150014	106	8517050	98	9002704	91
672305	172	7207200	223	757940	223	8026167	89	8150014	171	8517060	98	9002741	91
672305	224	7207250	154	757950	154	8026177	89	8150016	106	8517070	98	9002742	91
672308	172	7207250	223	757950	223	8027160	95	8150016	171	8517080	98	9002743	91
672308	224	7207300	154	757960	154	8029078	95	8150019	106	8517100	98	9002744	91
672310	172	7207300	223	757960	223	8030100	90	8150019	171	8527160	95	9002762	92
672310	224	7207350	154	757970	156	8030125	90	8151090	93	8529078	95	9002763	92
672314	172	7207350	223	757971	156	8030150	90	816020	317	854016	226	9002764	92
672314	224	7207400	154	789035	132	8030180	90	8177005	172	854017	228	9002765	92
672316	172	7207400	223	789035	318	8030200	90	8177060	172	854117	228	9002772	92
672316	224	7207500	154	789040	132	8030250	90	8177080	172	854117	304	9002773	92
673012	316	7207500	223	789040	318	8030330	90	8177100	172	8551090	93	9002774	92
674012	316	7207600	154	790040	132	8031250	91	8177120	172	8552095	95	9011204	89
675014	99	7207600	223	790040	318	8031300	91	8177140	172	8553045	95	9013170	94
677803	131	721890	17	794025	105	8051090	93	8177160	172	8554040	95	9013230	94
677812	100	7239034	177	794025	310	8052095	95	8177180	172	856514	226	9013280	94
677812	123	7251001	176	794035	105	8053045	95	8177200	172	8569125	92	9014170	94
677816	100	7351011	176	794035	310	8062050	99	8178060	213	8569175	92	9014230	94
677816	123	7351600	176	794040	105	8062070	99	8178100	213	8569225	92	9014280	94
677820	100	735816	157	794040	310	8062100	99	8178160	213	8570070	95	9016100	94
677820	123	738060	234	795214	106	8062120	99	8207015	154	857210	215	9016125	94
685834	290	738060	296	795214	214	8062140	99	8207020	154	857210	227	9016150	94

INDEX NUMÉRIQUE

9016200	94	BAF12C12AF	282	C411101	116	C480301	130	FDL26R32AF	268	OCP02C40AF	272	VOL20P16AF	275
9018150	94	BAF141R12A	278	C411201	116	C480401	130	FDL27R25AF	269	OCPI1R55AF	272	VOL22P14AF	275
9018200	94	BAF142C16A	278	C412101	121	C480501	130	FDL27R32AF	269	OCP15R90AF	272	VOL22P16AF	275
9018250	94	BAF164R14A	279	C412201	121	C480701	130	FDL29R20AF	269	OGC03R12AF	271	VOL23P14AF	275
902013	94	BAF164R1AF	279	C413401	119	C481802	129	FDL29R30AF	269	OGC03R14AF	271	VOL23P16AF	275
902017	94	BAF16C12AF	281	C413701	119	C481803	129	FDL33R20AF	269	OGC03TR14A	271	VOL27R12AF	275
9020206	90	BAF189R12A	280	C421201	117	C481805	129	FDL33R25AF	269	OGC03TR16A	271	VOL28R12AF	275
902023	94	BAF190R12A	280	C421601	117	C488801	129	FDL41C16AF	267	OGC04R14AF	270	VOL33P12GA	276
902213	94	BAF21C12AF	282	C421701	117	C493301	130	FDL42C16AF	267	OGC05R14AF	270	VOL34P121A	277
902217	94	BAF22C12AF	282	C440301	112	C627225	16	FDL42C20AF	267	OGC08R14AF	270	VOL34P12AF	276
902223	94	BAF23C14AF	279	C440401	112	C627225	110	FDL45R16AF	267	OGC08R16AF	270	VOL36P12DA	276
9115085	171	BAF24C14AF	279	C440501	112	C627230	16	FDL45R20AF	267	OGC09R14AF	270	VOL37P12AF	276
9151011	177	BAF25C12AF	281	C440601	112	C627230	110	I6SX156	290	OGC09R16AF	270	VOL38P12AF	276
9158085	105	BAF25C12DA	281	C440701	112	C641075	112	M685900	151	OGC23R12AF	271	VOL39P12AF	276
9158085	171	BAF26C12AF	281	C440801	112	C641081	114	M687110	128	OGC23R14AF	271	VOL50R12AF	274
9177002	220	BAF31C14AF	279	C440901	112	C641100	111	M687115	127	OGC23R16AF	271	VOL52P14AF	274
921515	94	BAF32C14AF	278	C441001	112	C641102	111	M687125	127	OGC24R40AF	270	VOL67P40AF	273
921517	94	BAF36C12AF	283	C441101	112	C641104	111	M687130	128	OGC49C14AF	270	VOL68P40AF	273
921520	94	BAF37C12AF	283	C441201	112	CDT03P30AF	278	M687210	128	OGC49C16AF	270	VOL69P120A	274
921529	94	BAF51C12AF	283	C441301	112	CDT05P25AF	278	M687230	128	OGC53C12AF	271	VOL69P121A	274
9242100	102	BAF65C14AF	283	C443511	114	FDL00R20AF	266	M795001	105	OGC53C14AF	271	VOL70P12AF	274
9251001	176	BAF88R12AF	280	C444101	113	FDL00R26AF	266	M795001	310	OGC54R14AF	270	VOL71P76AF	275
9351600	176	BAF89R12AF	280	C444201	113	FDL01R12AF	266	M825804	291	OGC54R16AF	270	VOL72R12AF	274
9503501	316	C176007	16	C444301	113	FDL01R17AF	266	MOT01P10AF	277	OMC02P44AF	287	VOL73P120A	273
9524006	230	C176007	111	C444501	113	FDL01R20AF	266	MOT02P16AF	277	OMC03PVAF	287	VOL73P121A	273
9529203	169	C176010	16	C444601	113	FDL02R13AF	266	MOT03P16AF	277	OMC04P28AF	287	VOL74P12AF	273
9530900	18	C176010	111	C450102	125	FDL02R16AF	266	MOT09P12AF	277	OMC05P40AF	287		
9535900	20	C176014	16	C450501	125	FDL02R20AF	266	MOT09P8AF	277	OMC17PVAF	287		
9537200	19	C176014	111	C451001	125	FDL03R28AF	267	MOT13P20AF	277	OMC32PVAF	287		
9541600	102	C218040	99	C451101	125	FDL03R31AF	267	MOT14P20AF	278	OMC80L21AF	287		
9541900	102	C400241	116	C451401	125	FDL04R16AF	268	MOT74P14AF	277	OPA02FL3AF	288		
9542600	103	C402101	119	C451502	125	FDL05C14AF	269	MOT74P20AF	277	OPA02FL4AF	288		
9544100	25	C402201	119	C452001	125	FDL12C25AF	267	MOT76P14AF	277	OPA02FL52A	288		
9544400	23	C402301	119	C452201	125	FDL14R12AF	266	MOT76P16AF	277	ORO06R125A	288		
9544402	23	C402401	119	C452301	125	FDL14R16AF	266	MOT77P20AF	277	ORO06R55AF	288		
9624100	153	C403101	116	C452401	125	FDL15R38AF	268	OBO01R25AF	273	ORO06R90AF	288		
9624100	222	C403135	122	C452601	125	FDL16R12AF	267	OBO01R30AF	273	ORO07R68AF	288		
9629600	151	C403201	116	C452801	125	FDL17R13AF	266	OBO01R40AF	273	TRA01C14AF	285		
9630000	22	C403401	116	C453001	125	FDL17R171A	266	OBO01R50AF	273	TRA11C16AF	285		
9925015	16	C403435	122	C453501	125	FDL17R17AF	266	OCA00C12AF	272	TRA26C20AF	285		
9925015	110	C403501	116	C453701	125	FDL19R28AF	268	OCA00C14AF	272	TRA50C16AF	286		
BAC15R165A	284	C405101	119	C455101	126	FDL19R35AF	268	OCA00C16AF	272	TRA57R16AF	286		
BAC15R16AF	284	C410101	116	C455201	126	FDL20R20AF	266	OCA01C25AF	272	TRA60C20AF	286		
BAC16C16AF	284	C410102	116	C456302	124	FDL21R16AF	266	OCA01C30AF	272	TRA67R20AF	286		
BAC22C165A	284	C410201	116	C456601	124	FDL22R15AF	267	OCA01C35AF	272	TRA80R14AF	285		
BAC22C16AF	284	C410301	116	C457001	124	FDL23R25AF	268	OCA01C40AF	272	TRA81R16AF	285		
BAF03C14LA	280	C410401	116	C462001	122	FDL23R33AF	268	OCA02C20AF	272	TRA82R20AF	286		
BAF04C14LA	280	C410501	116	C462601	123	FDL24R12AF	268	OCA03R16AF	272	TRA83C14AF	284		
BAF05C12AF	282	C410601	116	C466101	121	FDL24R15AF	268	OCA03R20AF	272	TRA85C16AF	284		
BAF06C12AF	282	C410701	116	C466201	121	FDL25R12AF	268	OCA03R30AF	272	TRA86C20AF	285		
BAF07C12AF	282	C410801	116	C466301	121	FDL25R15AF	268	OCA04C35AF	272	VOL12P12AF	275		
BAF09C12AF	281	C410901	116	C466401	121	FDL26R25AF	268	OCA10R12AF	272	VOL12P14AF	275		
BAF10C12AF	281	C411001	116	C480201	130	FDL26R30AF	268	OCA13C80AF	272	VOL20P14AF	275		

INDEX ALPHABÉTIQUE

Accessoires espagnolette aluminium rainurée	185	Arrêt tête bergère zamak à visser	182
Accessoires espagnolette ronde rainurée	174	Arrêteoir de fin de course	220
Accessoires espagnolette zamak rainurée	185	Attache souple lame épaisse	207
Accessoires pour espagnolette plate acier	175	Attache souple lame souple	207
Agrafe picarde coudée	170	Axe de gond amovible	161
Agrafe pour étagère	102	Axe pour gond collier 825814	291
Agrafe triangulaire universelle	102	Bague de paumelle	21
Agrafe volet nord coudée	170	Bague de propreté pour gond	163,181
Ancre de poteau à larder à sceller	130	Bague paumelle picarde	21
Ancre de poteau L à sceller	130	Balconnet Galerne à sceller	255
Ancre de poteau U à sceller	130	Balconnet Levant à sceller	254
Anneau	315	Balconnet Lombarde à sceller	255
Anneau à boulonner avec écrou	315	Balconnet Mistral à sceller	254
Anneau à sceller	315	Balconnet Nordet à sceller	254
Anneau à visser	315	Bande perforée	114
Anneau de tirage	196	Barre d'appui Galerne /ml	253
Anneau pour dalle à sceller	315	Barre d'appui Levant/ml	253
Anneau pour dalle sur platine	315	Barre d'appui Tramontane r/ml	253
Arrêt à pince	27	Barre de contrevent à sceller	292
Arrêt automatique aluminium	183	Barre de sécurité à boutons	194,238
Arrêt BlocVolet	168	Barre de sécurité à serrure 2 points	27
Arrêt composite automatique	183	Barre de sécurité garage	218
Arrêt de chaîne	206	Barre de sécurité persienne recoupable	198
Arrêt de persienne inox à visser + butée	198,213	Barre de sécurité plate à ergots	194,238
Arrêt de portail à bascule à sceller	293	Barre de sécurité réglable 6 points	193,237
Arrêt de portail à bascule à sceller réglable	293	Barre de sécurité renforcée	193,235,237
Arrêt de portail à sceller	298	Barre de sécurité renforcée + cadenas	193,237
Arrêt de portail automatique à ressort à sceller	293	Barre de sécurité ronde	193,237
Arrêt de portail automatique mural à ressort à visser	293	Barre de sécurité verrou	194,238
Arrêt de volet à poignée	167	Barre de verrouillage volet roulant	208
Arrêt de volet à ressort autobloquant	167	Barreau à épines	241
Arrêt de volet à ressort autobloquant inox	212	Barreau clôture 15	284
Arrêt de volet Bloc Boy	168	Barreau clôture 16	284
Arrêt de volet Verouilvolet	167,183	Barreau clôture 22	284
Arrêt persienne à visser	196	Barreau fantaisie 03	280
Arrêt pour portail motorisé à sceller	299	Barreau fantaisie 04	280
Arrêt StopVolet	168	Barreau fantaisie 05	282
Arrêt tête bergère à sceller	166	Barreau fantaisie 06	282
Arrêt tête bergère à visser	166	Barreau fantaisie 07	282
Arrêt tête bergère à visser + butée	166	Barreau fantaisie 09	281
Arrêt tête bergère acier à visser	190	Barreau fantaisie 10	281
Arrêt tête bergère composite à visser	190	Barreau fantaisie 12	282
Arrêt tête bergère composite à visser S4000	182	Barreau fantaisie 141	278
Arrêt tête bergère sur platine à visser	166	Barreau fantaisie 142	278

INDEX ALPHABÉTIQUE

Barreau fantaisie 16	281
Barreau fantaisie 164	279
Barreau fantaisie 164	279
Barreau fantaisie 189	280
Barreau fantaisie 190	280
Barreau fantaisie 21	282
Barreau fantaisie 22	282
Barreau fantaisie 23	279
Barreau fantaisie 24	279
Barreau fantaisie 25	281
Barreau fantaisie 25	281
Barreau fantaisie 26	281
Barreau fantaisie 31	279
Barreau fantaisie 32	278
Barreau fantaisie 36	283
Barreau fantaisie 37	283
Barreau fantaisie 51	283
Barreau fantaisie 65	283
Barreau fantaisie 88	280
Barreau fantaisie 89	280
Bâton de tirage	206
Béquille double	310
Béquille double Portland	38
Béquille double torsadée	38
Bloc distributeur de gel savon ou mousse sans contact	321
Bloqueur de manivelle classic	202
Bloqueur de manivelle design	202
Bloqueur de manivelle magnétique	202
Boîtier de serrure	309
Bouchon de protection	207
Boule 01	273
Boulon tête diamant	152
Boulon TRCC	152
Boulon TRCC aluminium	180
Boulon TRCC inox	210
Bouton de fenêtre Newport	40
Bouton de fenêtre Portland	39
Bouton de fenêtre Puget	40
Bouton de porte double Dahlia + tige	26
Bouton de porte double N°102 + tige	26
Bouton double - N°59	302
Bouton double Ovo	38
Bouton double Portland	38,39
Bride de barrière	234,296

Bride de fixation	220
Butée à vis + tampon composite	186
Butée coudée à sceller	177
Butée coudée à vis	176
Butée coudée à visser	177
Butée coudée réglable à visser	177
Butée coudée réglable à visser + tampon composite	186
Butée coudée ronde à visser	176
Butée de fin de course capot composite	312
Butée de fin de course portail coulissant + tampon de réception	309
Butée de persienne à visser	196
Butée de persienne inox à visser	198,213
Butée de portail coulissant à souder	308
Butée de portail coulissant à visser	308
Butée de volet inox à vis	213
Butée droite à sceller	177
Butée droite à vis	176
Butée lame finale	207
Butée murale composite à visser	184
Butée tourniquet marseillais inox	212
Butée universelle pour tourniquet marseillais	166
Cache-scellement 01	272
Cache-scellement 03	272
Cache-scellement 10	272
Cache-scellement 13	272
Cale arrêt composite automatique	183
Cale pour sabot de portail composite	299
Capot de pivot	303
Carré à trous & 1 goupille	62
Carré à trous & 2 goupilles	61
Carré fendu à gorge	61,62
Carré lisse	63
Carré percé des 2 bouts	63
Chainette de porte fonte	26
Chainette épinglette	26
Chapeau de poteau boule	128
Chapeau de poteau pointe diamant	127
Chapiteau de crémone	67
Chariot + boulon	220
Charnière à congés	156
Charnière à penture	155
Charnière à piano	103
Charnière à ressort double action	22
Charnière à ressort simple action	22

INDEX ALPHABÉTIQUE

Charnière automatique TRUE-CLOSE	300	Console moderne courbe aluminium	92
Charnière d'extrémité sur chant	219	Console new design acier	89
Charnière d'extrémité sur chant bouts carrés	219	Console perfection acier	88
Charnière d'extrémité sur chant bouts carrés + axe	219	Console renforcée acier	90
Charnière de caisse à coulisse	103	Console renforcée aluminium	91
Charnière de caisse bouts droits	103	Console renfort 2000 acier	89
Charnière de caisse bouts ronds	104	Console robuste acier	90
Charnière de caisse triangle	104	Console simple - Entraxe 50 mm	86
Charnière de jumelage queue de carpe	155	Console simple aluminium	91
Charnière de meuble carrée	102	Console support de pots acier	92
Charnière de meuble rectangulaire	102	Console très lourde charge acier	91
Charnière de milieu sur chant + axe	219	Console TS acier	89
Charnière de table	104	Console volute acier	92
Charnière décorative	157	Contre-équerre bout queue de carpe	150
Charnière double axe composite	156	Contre-équerre bouts carrés	150
Charnière forte	156	Contre-penture aluminium bout droit	180
Charnière intermédiaire	157	Contre-penture aluminium bout feston	180
Charnière renforcée inox	210	Contre-té bout queue de carpe	151
Cheville 4 segments	158	Convertisseur de gond	163
Circlips	64	Cornière antieffraction	27
Clé de tirant	278	Couplet niçois + visserie	155
Clenche universelle	233	Couvre-pilastre 02	272
Clou vis tête diamant	152	Couvre-pilastre 11	272
Coin de malle	107	Couvre-pilastre 15	272
Compas de tréteaux	104	Crapaudine à sceller fonte	292
Console 1/4 cercle double acier	93	Crapaudine à visser cupro-aluminium	298
Console 1/4 cercle ovale acier	93	Crapaudine composite à visser	298
Console 1/4 cercle simple acier	93	Crémaillère de meuble	103
Console bandeau acier	93	Crémaillère de portail PVC	312
Console bois éco pin brut	94	Crémaillère double - Entraxe 32 mm	86
Console bois lamellée hêtre	94	Crémaillère L	173
Console bois moderne hêtre	94	Crémaillère simple - Entraxe 50 mm	86
Console bois pratic pin brut	94	Crémone décorative + Bouton	66
Console bois rustique	94	Crémone fonctionnelle + bouton	66,67
Console bois rustique plein	94	Crémone fonctionnelle + bouton ovale	66
Console colorite acier	89	Crochet + crémaillère à poignée	173,224
Console contemporaine aluminium	92	Crochet + crémaillère en L	173
Console décorative acier	91	Crochet + crémaillère inox	213
Console double - Entraxe 32 mm	86	Crochet aluminium sur platine + crémaillère en T	184
Console emboutie acier	88	Crochet aluminium sur platine antichoc + crémaillère à poignée	184
Console escamotable acier	91	Crochet de bâchage à visser	316
Console fer rustique acier rustique	92	Crochet de contrevent + pitons	172,224
Console lourde charge acier	90	Crochet de contrevent + pitons inox	213
Console moderne acier	89	Crochet de gymnase à boulonner	316

INDEX ALPHABÉTIQUE

Crochet de gymnase à visser	316	Ensemble sur plaque Houston	43
Crochet de hamac sur platine	316	Ensemble sur plaque Medicis	36
Crochet de rappel	178, 197	Ensemble sur plaque Mississippi	44
Crochet décoratif acier	95	Ensemble sur plaque Newport	32
Crochet décoratif coudé acier	95	Ensemble sur plaque Oakland	43
Crochet pour fermoir	108	Ensemble sur plaque Oblongue Ondine	44
Crochet sur platine + crémaillère L	173	Ensemble sur plaque Opio	36
Demi ensemble sur plaque entrée inox	41, 42	Ensemble sur plaque Ostende	32
Demi-sabot de verrou	221	Ensemble sur plaque Phoenix	42
Départ de rampe 02	287	Ensemble sur plaque Piccadilly	31
Départ de rampe 04	287	Ensemble sur plaque ronde Sherwood	47, 48
Départ de rampe 05	287	Ensemble sur plaque Seattle	41
Dérouleur essuie-mains mural ou à poser	324	Ensemble sur plaque Sydney	30
Dérouleur essuie-mains mural ou à poser avec lame de découpe	323	Ensemble sur plaque Toronto	30
Dérouleur essuie-mains sur pied	324	Ensemble sur plaque Trévi	33
Dérouleur essuie-mains sur pied et porte sac poubelle intégré	323	Ensemble sur plaque Upper	49
Distributeur sans contact de gel hydroalcoolique	321	Ensemble sur plaque Vence	31
Enrouleur pivotant pour sangle 20/22 mm	203	Ensemble sur plaque Villandry	33
Enrouleur pivotant réglable + sangle 14/15 mm	204	Ensemble sur rosace Arobase	55
Enrouleur pivotant réglable à cordon	205	Ensemble sur rosace Bilboquet	55
Enrouleur sous carter pivotant + sangle 14/15 mm	204	Ensemble sur rosace carrée Aquilis	58, 59, 60
Enrouleur sous carter pivotant pour sangle 14/15 mm	203	Ensemble sur rosace carrée Arthémis	58, 59, 60
Ensemble béquille et plaque	300	Ensemble sur rosace carrée Atlanta	46
Ensemble sur plaque Alhambra	32	Ensemble sur rosace carrée Brooklyn	56
Ensemble sur plaque Arobase	51	Ensemble sur rosace carrée Central Park	56
Ensemble sur plaque Atlanta	43	Ensemble sur rosace carrée Kansas	46
Ensemble sur plaque Austin	42	Ensemble sur rosace carrée Phileas	58, 59, 60
Ensemble sur plaque Baltimore	41	Ensemble sur rosace carrée Thorsion	58, 59, 60
Ensemble sur plaque Beaugency	33	Ensemble sur rosace ronde Arobase	53, 54
Ensemble sur plaque Bilboquet	50	Ensemble sur rosace ronde Bilboquet	53, 54
Ensemble sur plaque Boston	36	Ensemble sur rosace ronde Broceliande	48
Ensemble sur plaque Brooklyn	52	Ensemble sur rosace ronde Charlotte	45
Ensemble sur plaque carrée Broceliande	47, 48	Ensemble sur rosace ronde Club	45
Ensemble sur plaque Charlotte	42	Ensemble sur rosace ronde Cluny	34
Ensemble sur plaque Dallas	41	Ensemble sur rosace ronde Indianapolis	34
Ensemble sur plaque Détroit	41	Ensemble sur rosace ronde Long Beach	45
Ensemble sur plaque étroite Central Park	52	Ensemble sur rosace ronde Oakland	46
Ensemble sur plaque étroite Columbus	35	Ensemble sur rosace ronde Saint Andrews	34
Ensemble sur plaque étroite Portland	35	Ensemble sur rosace ronde Sherwood	47, 48
Ensemble sur plaque étroite Tucson	35	Ensemble sur rosace ronde Toledo	37
Ensemble sur plaque Florida	44	Ensemble sur rosace ronde Tucson	37
Ensemble sur plaque Grasse	31	Ensemble sur rosace ronde Upper	53, 54
Ensemble sur plaque Guedelon	36	Ensemble sur rosace Upper	55
Ensemble sur plaque Hossegor	30	Entrebâilleur de sécurité	238

INDEX ALPHABÉTIQUE

Entrebâilleur de volet	194	Fer de lance 16	267
Entrée de boîte aux lettres	302,318	Fer de lance 17	266
Entretoise pour gond acier	189	Fer de lance 19	268
Equerre 135°	122	Fer de lance 20	266
Equerre bout droit	150	Fer de lance 21	266
Equerre bout queue de carpe	150	Fer de lance 22	267
Equerre clôture bois avec vis	131	Fer de lance 23	268
Equerre d'ancrage	121	Fer de lance 24	268
Equerre d'assemblage réglable	117,118	Fer de lance 25	268
Equerre d'assemblage renforcée	119	Fer de lance 26	268
Equerre d'assemblage renforcée réglable	120	Fer de lance 27	269
Equerre d'assemblage simple	116	Fer de lance 29	269
Equerre de cadre	100,123	Fer de lance 33	269
Equerre de caisse	98, 100	Fer de lance 41	267
Equerre de chaise renforcée	99	Fer de lance 42	267
Equerre de charpente	122	Fer de lance 45	267
Equerre de châssis	99	Ferme-porte ajustable	25
Equerre de châssis coudée	99	Ferme-porte ressort spirale	25
Equerre de chéneaux	115	Fermeture de volet + support	169
Equerre de coin	100	Fermeur à levier	107
Equerre de fenêtre	101	Fermeur à levier + crochet	107
Equerre de poutre	114	Fermeur à levier porte-cadenas	107
Equerre de renfort	99	Fermeur grand modèle N°15	107
Equerre découpée	101	Fiche à visser standard	21
Equerre demi-ronde acier	90	Fiche à visser style	21
Equerre en T	100	Fixation de rampe à vis	96
Equerre en T cambrée	100	Fixe-porte à pédale	24
Equerre en U clôture bois avec vis	131	Fléau de portail	234,296
Equerre nervurée 3 pans coupés	16,11	Fourreau de passage	64
Equerre nervurée droite	16,11	Gabarit de perçage acier	163
Equerre renvoyée	121	Gabarit de perçage composite	163
Equerre tronquée renforcée	16	Gâche à visser	230
Equerre tronquée renforcée angle 45°	111	Gâche d'arrêt	219
Esse de boucher inox	214,316	Gâche de crémone	67
Fer à joint fonte	318	Gâche de sabot de portail	295
Fer de lance 00	266	Gâche de verrou rond à encastrer	229
Fer de lance 01	266	Gâche portail coulissant	307
Fer de lance 02	266	Gâche pour pêne rectangulaire	25
Fer de lance 03	267	Garde-corps Levant	256
Fer de lance 04	268	Garde-corps Mistral	256
Fer de lance 05	269	Garde-corps Nordet	256
Fer de lance 12	267	Genouillère acier chrome	201
Fer de lance 14	266	Genouillère acier laqué	201
Fer de lance 15	268	Gond à collier réglable	291

INDEX ALPHABÉTIQUE

Gond à collier réglable sans axe	291	Grille de hublot	241
Gond à plaquer axe amovible	159	Grille éco à sceller	241
Gond à plaquer bout queue de carpe axe amovible	159	Grille Galerne à sceller	245
Gond à scellement chimique	161	Grille Levant à sceller	243
Gond à scellement chimique acier	189	Grille Libeccio à sceller	250
Gond à scellement chimique composite	181, 189	Grille Lombarde à sceller	247
Gond à scellement chimique inox + axe laiton	211	Grille Lombarde à sceller en façade	248
Gond à sceller 2 lames inox + axe laiton	211	Grille Marine à sceller	246
Gond à sceller composite	181	Grille Mistral à sceller	244
Gond à sceller cupro-aluminium	298	Grille Nordet à sceller	245
Gond à sceller inox + axe laiton	211	Grille ouvrante 1 vantail/m ²	258
Gond à sceller réglable	290	Grille ouvrante 2 vantaux/m ²	258
Gond à sceller renforcé	157	Grille Ponant à sceller	243
Gond à sceller simple	157	Grille Solano à sceller	244
Gond à souder	302	Grille Tramontane à sceller	247
Gond à visser + cache composite	298	Grille Vendée à sceller	250
Gond à visser + cheville métal	158	Grille Zephyr à sceller	249
Gond à visser composite	181	Guide "Stop vent" chaîne ou sangle	206
Gond à visser cupro-aluminium	298	Guide de portail à sceller - 2 olives	306
Gond à visser inox + axe laiton	211	Guide de portail à visser - 2 olives	306
Gond à visser tirefond	158	Guide-sangle classic	205
Gond à visser tirefond haut	158	Guide-sangle design	205
Gond d'angle bout queue de carpe axe amovible	159	Hublot rectangulaire	218
Gond de poteau traversant	290	Jeu de pivot à sceller	303
Gond poteau + butée	290	Judas optique	24
Gond pour isolation extérieure Isogond	189	Judas porte-nom	24
Gond Statex® + chevilles	290	Kit butée à vis	176
Gond sur platine bout carré inox + axe laiton	211	Kit complet espagnolette plate	175
Gond sur platine bout droit	159	Kit complet espagnolette ronde pleine	174
Gond sur platine bout queue de carpe	159	Kit manivelle complet classic	202
Gond sur platine courte bout droit	159	Kit manivelle décrochable	201
Gond sur platine réglable bout carré	290	Kit peinture spécial volet double	151
Gond sur té bout droit - Axe amovible	160	Kit portail sécurité enfant	300
Gond sur té bout queue de carpe	160	Kit support barre de sécurité pour carré 16	192,236
Gond sur té bout queue de carpe - Axe amovible	160	Kit verrouillage automatique volet roulant	208
Goujon espagnolette	178	Lame mâle mixte	23
Goupille de sécurité	69	Loquet de persienne + support	197
Goupille pour carré à trou	64	Loquet de portail LOCKKLATCH	300
Grille Aquilon à sceller	249	Loquet de porte à bascule avec poignée	233
Grille Astrale à sceller	251	Loquet de sécurité cadenassable	234,296
Grille Autan à sceller	246	Loquet droit + support	197
Grille Bora à sceller	251	Loqueteau de fenêtre	68
Grille d'aération ronde	318	Main courante 03	287
Grille de défense télescopique	240	Main courante 17	287

INDEX ALPHABÉTIQUE

Main courante 32	287	Ouvre-porte pour pied double action inox - lot de 2	322
Melle tige filetée	291	Ouvre-porte sans contact	322
Mini fermail à levier	107	PALBOX - Moustiquaire COSI Serena - Pour fenêtres	75
Mini sabot	124	PALBOX - Moustiquaire COSI UP - Pour volets roulants	81
Motif 01	277	PALBOX - Moustiquaire COSI Zena - Pour fenêtres	77
Motif 02	277	Palmette 02	288
Motif 03	277	Panneton + agrafe	170
Motif 09	277	Panneton droit	170
Motif 13	277	Patte à pointe coudée	17
Motif 14	278	Patte à pointe droite	17
Motif 74	277	Patte à scellement tête ronde	17
Motif 76	277	Patte d'assemblage	101
Motif 77	277	Patte d'assemblage forte	112
Moustiquaire - Pour baies-vitrées	78	Paumelle à souder bout rond + graisseur	23
Moustiquaire COSI Bazar - Pour fenêtres	83	Paumelle bois coudée à 100° bouts ronds	20
Moustiquaire COSI Bazar - Pour porte-fenêtres	83	Paumelle bois coudée à 90° bouts ronds	20
Moustiquaire COSI Serena - Pour fenêtres	75	Paumelle de grille à souder	22,23
Moustiquaire COSI Serena - Pour porte-fenêtres	75	Paumelle de grille à souder extra-forte	23
Moustiquaire COSI Serena- Pour porte- fenêtres	75	Paumelle de Paris bois bouts carrés	18
Moustiquaire COSI UP - Pour volets roulants	81	Paumelle de Paris bois bouts ronds	18,19
Moustiquaire COSI Zena - Pour fenêtres	77	Paumelle de Paris bois inox bouts ronds	19,21
Moustiquaire COSI Zena - Pour porte-fenêtres	77	Paumelle de sécurité	20
Moustiquaire extensible DERBY - Pour volets roulants	82	Paumelle espagnole	20
Moustiquaire Garden - Pour Porte-battantes	78	Paumelle Picarde	19
Moustiquaire MOSKITO - Pour fenêtres	84	Paumelle Profix®	20
Nœud à souder	302	Paumelle sans lame Profilsoud®	22
Œil-de-bœuf Autan à sceller	252	Penture aluminium bout droit	180
Œil-de-bœuf Levant à sceller	252	Penture aluminium bout feston	180
Œil-de-bœuf Mistral à sceller	252	Penture anglaise	153,222
Œil-de-bœuf Nordet à sceller	252	Penture anglaise axe composite	223
Œil-de-bœuf Tramontane à sceller	252	Penture anglaise festonnée inox	210
Olive de guidage Ø25	306	Penture anglaise forte	154,223
Olive de guidage Ø30	306	Penture anglaise forte axe composite	154
Ornement 03	271	Penture anglaise inox	210
Ornement 04	270	Penture anglaise légère	153,222
Ornement 05	270	Penture bout droit	148
Ornement 08	270	Penture bout droit inox	210
Ornement 09	270	Penture bout queue de carpe	149
Ornement 23	271	Penture col équerre bout queue de carpe	149
Ornement 24	270	Penture coudée bout droit	149
Ornement 49	270	Penture festonnée	151
Ornement 53	271	Penture nord U	151
Ornement 54	270	Pièce de jonction pour rails coulissants gorge ronde	307
Ouvre-porte mains libres	322	Pied de poteau à enfoncer	128

INDEX ALPHABÉTIQUE

Pied de poteau à vis 2 plaques	129	Poignée sur platine bouts ronds	106, 171
Pied de poteau à vis réglable 2 plaques	129	Poignée sur platine bouts ronds inox	106
Pied de poteau à visser	128	Poignée sur platine inox bouts carrés	214
Piquet de tiers	132	Poignée sur platine inox bouts ronds	214
Piquet de tiers tête ronde	318	Pointe crantée	131
Piquet de tiers tête tournante	132, 318	Polygond à clips	161
Piton sur platine à visser	108	Polygond à clips renforcé fer à béton	161
Pivot de portail bois réglable à sceller	292	Porte-cadenas à recouvrement + piton	108
Plaque antisoulèvement	292	Porte-chapeau embouti acier	95
Plaque de guidage - 4 olives	306	Porte-chapeau embouti long acier	95
Plaque de liaison	111	Portée pour carré diamètre 8 mm	64
Plaque de réparation	114	Poteau balcon angle à visser	257
Plaque perforée	112	Poteau balcon angle Lombarde à visser	257
Platine	113	Poteau balcon départ à visser	257
Platine à visser pour poteau balcon	257	Poteau balcon jonction à visser	257
Platine porte-cadenas	108	Poulie à crochet fonte	317
Plomb de maçon avec plaque	318	Poulie à crochet nylon	317
Plomb mécanicien avec plaque	318	Poulie de puits	317
Poignée à pattes queue de carpe	171	Poulie fonte	317
Poignée de baquet	106	Poulie nylon	317
Poignée de crémone à clé N°1	69	Présentoir - Moustiquaires COSI Bazar	83
Poignée de fenêtre Mandelieu	40	Protecteur tête de butée composite	178
Poignée de fenêtre oscillobattante	40	Protecteurs volet composite	166
Poignée de fenêtre oscillobattante Carros	40	Raccord de rail	220
Poignée de fenêtre oscillobattante Cleveland	39	Rail courbe rayon 500 mm	219
Poignée de fenêtre oscillobattante Newport	40	Rail droit	219
Poignée de fenêtre Portland	39	Rail gorge ronde à visser	307
Poignée de fléau + support	169	Rail gorge V à visser	308
Poignée de fléau à blocage + support	169	Renfort de paumelle Goujon + douille	20
Poignée de fléau inox + support inox	213	Renfort de paumelle platine	20
Poignée de malle	106	Rondelle acier	162
Poignée de manivelle pour tringle Ø12 mm	202	Rondelle composite	162
Poignée de meuble coquille	104	Rondelle laiton	162
Poignée de porte de garage	221, 312	Rosace 06	288
Poignée de tirage	206	Rosace 07	288
Poignée de tirage courbe	310	Rosace de fonction carrée	46, 56, 58, 59, 60
Poignée de tirage demi-ronde	105, 310	Rosace de fonction Indianapolis	34
Poignée de tirage droite	105, 310	Rosace de fonction ronde	45, 46, 47, 48, 53, 54, 55
Poignée de tirage renforcée	105, 310	Rosace de fonction ronde Cluny	34
Poignée emboutie	105	Rosace de fonction ronde Saint-Andrews	34
Poignée fil à pattes	105, 171	Rosace de fonction ronde Toledo	37
Poignée fil à pattes inox	214	Rosace de fonction ronde Tucson	37
Poignée sur platine bouts carrés	106, 171	Rosace de fonction rondes Club	45
Poignée sur platine bouts carrés inox	106	Roue gorge U à encastrier Ø16	307

INDEX ALPHABÉTIQUE

Roue gorge U à encastrer Ø20	307	Support de rampe coudé réglable à visser	96
Roue gorge U support extérieur Ø16	307	Support de rampe droit réglable à visser	96
Roue gorge U support extérieur Ø20	307	Support espagnolette antisoulèvement	175
Roue gorge V à encastrer	308	Support espagnolette verrou	175
Roue gorge V support extérieur	308	Support main courante 80	287
Roulette support de portail	292	Support mural pour gel hydroalcoolique	320
Sabot à ailes pliables	126	Support ouvert barre de sécurité	236
Sabot à écart variable	126	Support pour gel hydroalcoolique	320
Sabot composite pour portail motorisé	299	Support simple barre de sécurité pour carré 16	192,235
Sabot de guidage	221	Tamis composite	161
Sabot de portail à basculeur réglable à visser	295	Tampon pour butée de portail à visser et à souder	309
Sabot de portail à sceller	294	Taquet de lit	108
Sabot de portail à sceller + gâche réglable	294	Taquet pour crémaillère	103
Sabot de portail à visser	295	Targette à pêne rond	26
Sabot de portail à visser + gâche réglable	295	Té	123
Sabot de portail anticorrosion à basculeur réglable à visser	295	Té bout droit	151
Sabot de portail automatique à visser	299	Té bout queue de carpe	151
Sabot de portail composite avec basculeur composite	299	Tendeur de grillage N°2	314
Sabot de portail inox à sceller	214,294	Tendeur de grillage N°3	314
Sabot de portail inox à visser	214,295	Tendeur de grillage N°4	314
Sabot de portillon à sceller	294	Tige passe-caisson recoupable	200
Sabot poutre ailes extérieures	125	Tige relieuse sectionnable	64
Sabot poutre ailes intérieures	124	Tirant de sablière	115
Sachet d'accessoires Provence	174	Toile Moustiquaire ROTOLO	84
Sangle	203	Tourniquet marseillais à sceller	165
Serrure à crochet avec gâche + cylindre 3 clés	309	Tourniquet marseillais à vis + cheville	164
Serrure à larder avec gâche et cylindre	309	Tourniquet marseillais à vis bois	164
Serrure de portail avec pêne antisoulèvement + gâche	300	Tourniquet marseillais acier à visser	190
Serrure de portillon avec pêne antisoulèvement + gâche	300	Tourniquet marseillais composite à visser	190
Serrure encastrée à crochet avec galet de recentrage	312	Tourniquet marseillais composite à visser S4000	182
Serrure extraplate 3 clés	208	Tourniquet marseillais composite Hélice à rouleau	182
Serrure plate	221	Tourniquet marseillais inox à sceller	212
Seuil de retour avec demi-sabot	220	Tourniquet marseillais inox à visser	212
Socle de finition pour arrêt motorisé à visser	299	Tourniquet marseillais plat à sceller	165
Sortie de caisson à 45°	200	Tourniquet marseillais sur platine à visser	164,165
Sortie de caisson déportée	200	Tourniquet marseillais zamak Hélice à rouleau	182
Sortie de caisson treuil à 90° + double cadran	200	Trappe de ramonage	318
Support à pédale pour gel hydroalcoolique	320	Traverse 01	285
Support antisoulèvement barre de sécurité pour carré 16	192,235	Traverse 11	285
Support charnière pour barre de sécurité 12 mm	192,236	Traverse 26	285
Support de barre de garage	218	Traverse 50	286
Support de barre ouvert	192	Traverse 57	286
Support de courbe	220	Traverse 60	286
Support de rampe coudé fixe à visser	96	Traverse 67	286

INDEX ALPHABÉTIQUE

Traverse 80	285
Traverse 81	285
Traverse 82	286
Traverse 83	284
Traverse 85	284
Traverse 86	285
Tringle plate pour espagnolette acier	175
Tringle pour crémone 16x5	68
Tringle pour crémone 16x8	68
Tringle pour manivelle	202
Tringle rainurée pleine Provence	174
Tube acier pour grille de défense télescopique	240
Tube espagnolette rainuré aluminium	185
Tube rainuré acier pour espagnolette	174
V de réception encastré + gâche	312
Verrou à clé à larder court	69
Verrou à tige cadenassable	232
Verrou antisoulèvement	208
Verrou antisoulèvement pour crochet de volet	173
Verrou automatique à bouton	25
Verrou baïonnette à ressort	231
Verrou baïonnette à souder	231,304
Verrou baïonnette à visser	230
Verrou baïonnette composite à visser	231
Verrou baïonnette de sécurité	231
Verrou baïonnette inox à visser	215,231
Verrou charnière à goupille	234,296
Verrou d'écurie porte-cadenas + gâche	233
Verrou de baie coulissante à clé	69
Verrou de barrière à bascule	232,234,296
Verrou de barrière à crosse rustique	232
Verrou de box à visser	226,304
Verrou de box à visser + gâche	226
Verrou de box composite à visser cadenassable + gâche	226
Verrou de box inox à visser + gâche	226
Verrou de box inox à visser + gâche inox	215
Verrou de box inox porte-cadenas + gâche	227
Verrou de box maxi à visser	226
Verrou de box porte-cadenas + gâche	227
Verrou de box porte-cadenas inox à visser + gâche	227
Verrou de box porte-cadenas inox à visser + gâche inox	215
Verrou de fenêtre universelle	69
Verrou de pied universel + platine à souder	228,304
Verrou de pied universel à souder	232,304

Verrou de porte à entailler	25
Verrou de porte à levier	25
Verrou de sécurité	232
Verrou espagnolette	175
Verrou magnétique anticorrosion	229,299
Verrou pistolet + gâche	227
Verrou pistolet à ressort	228
Verrou pistolet composite + gâche	229
Verrou pistolet inox à ressort	215,228
Verrou pistolet maxi à visser	228
Verrou rond	229
Verrou vervelle avec porte-cadenas et gâche	233
Violet niçois	155
Vis indévissables + chevilles	240
Vis peinture	152
Vis peinture sécurité	152
Volute 12	275
Volute 20	275
Volute 22	275
Volute 23	275
Volute 27	275
Volute 28	275
Volute 33	276
Volute 34	276
Volute 34	277
Volute 36	276
Volute 37	276
Volute 38	276
Volute 39	276
Volute 50	274
Volute 52	274
Volute 67	273
Volute 68	273
Volute 69	274
Volute 70	274
Volute 71	275
Volute 72	274
Volute 73	273
Volute 74	273



AFBAT ZI Cher du Prat
23000 GUERET



info@afbat.com



+33 5 55 51 92 50



www.afbat.com

SUIVEZ-NOUS SUR

